



PORTFOLIO 3

IDSN 2102-001

Fall 2018

Karen Sandoval

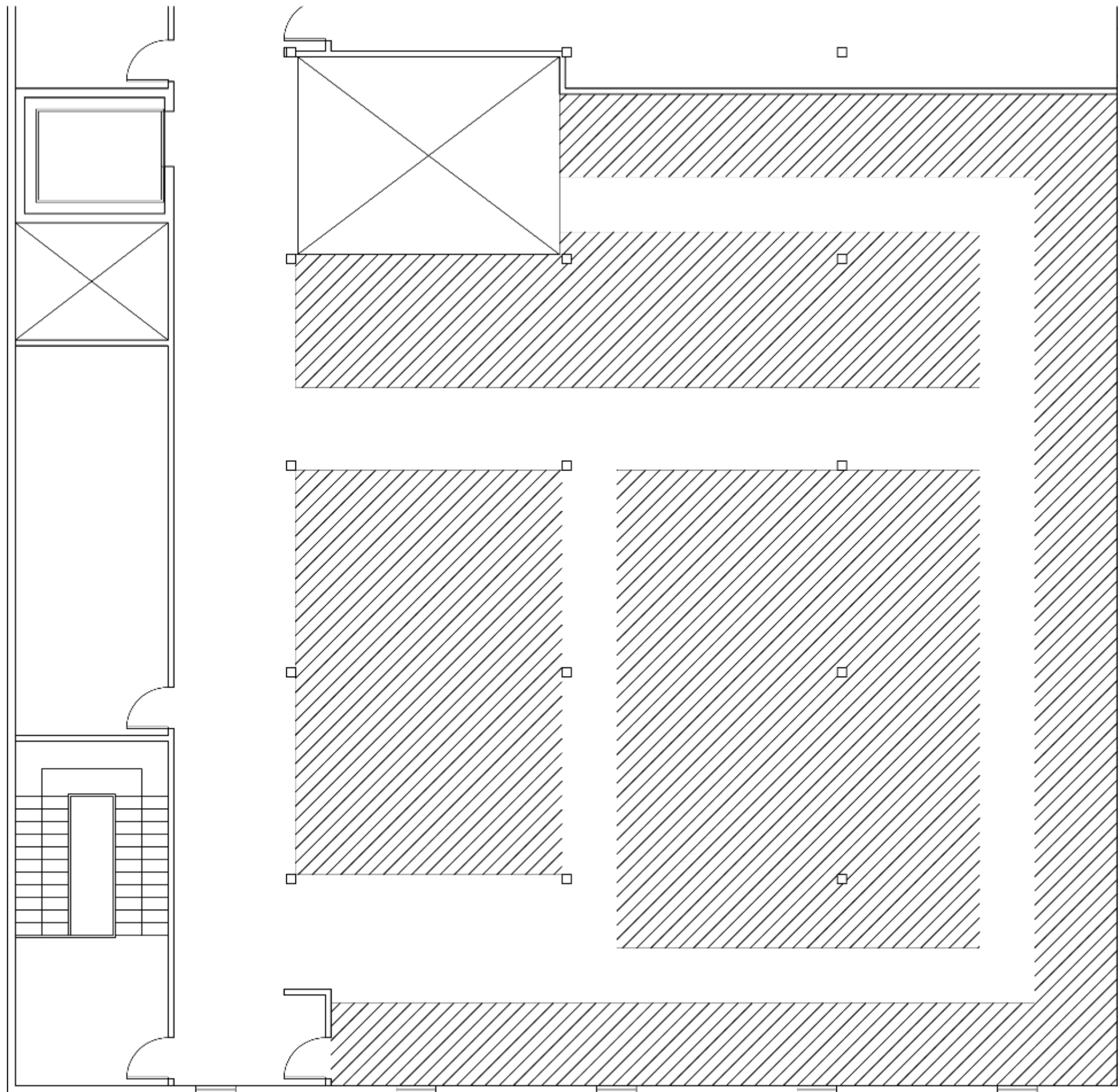

Circulation Plan 1
1/8' ' = 1' -0' '

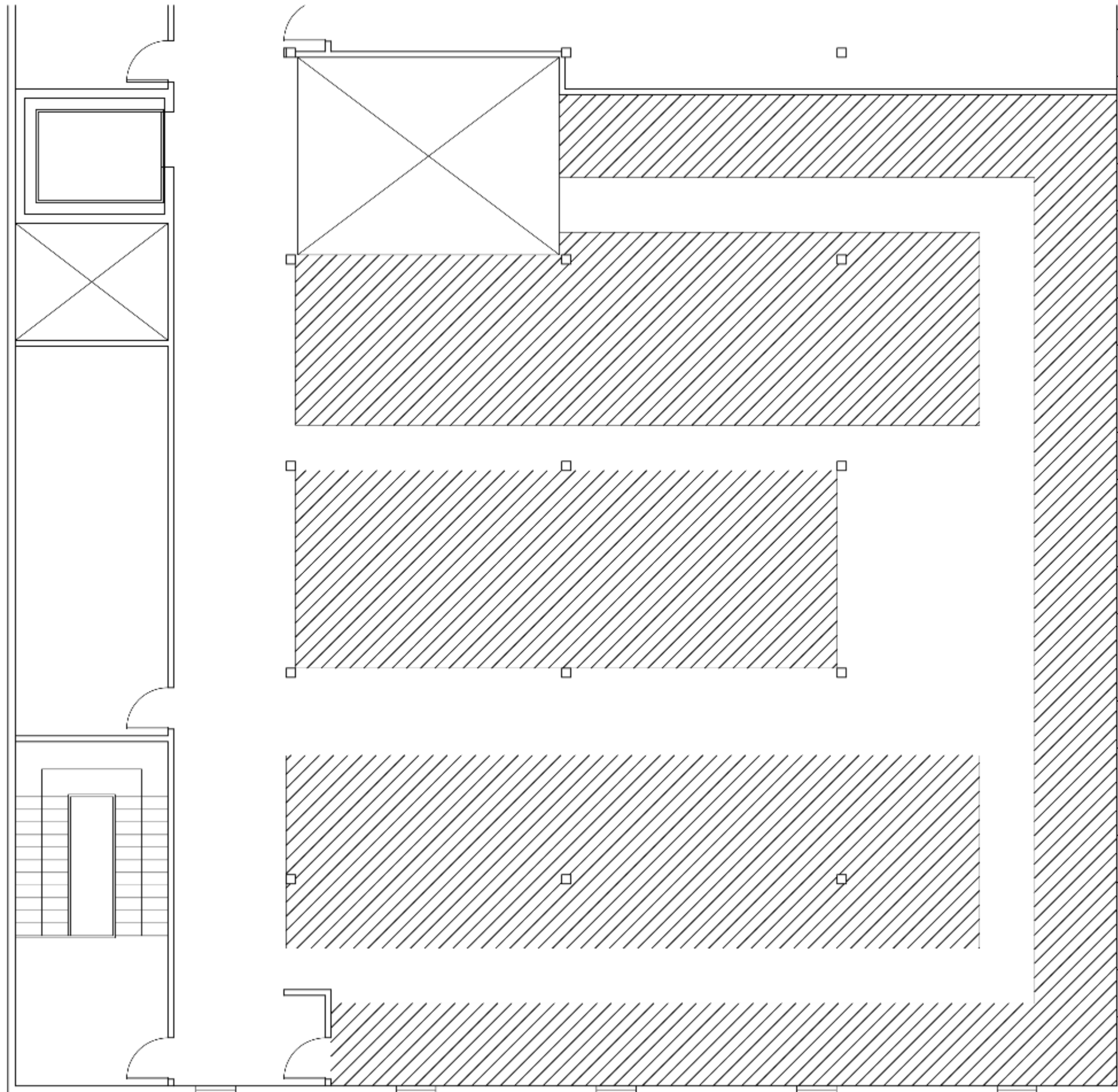

Circulation Plan 2
1/8' ' = 1' -0' '

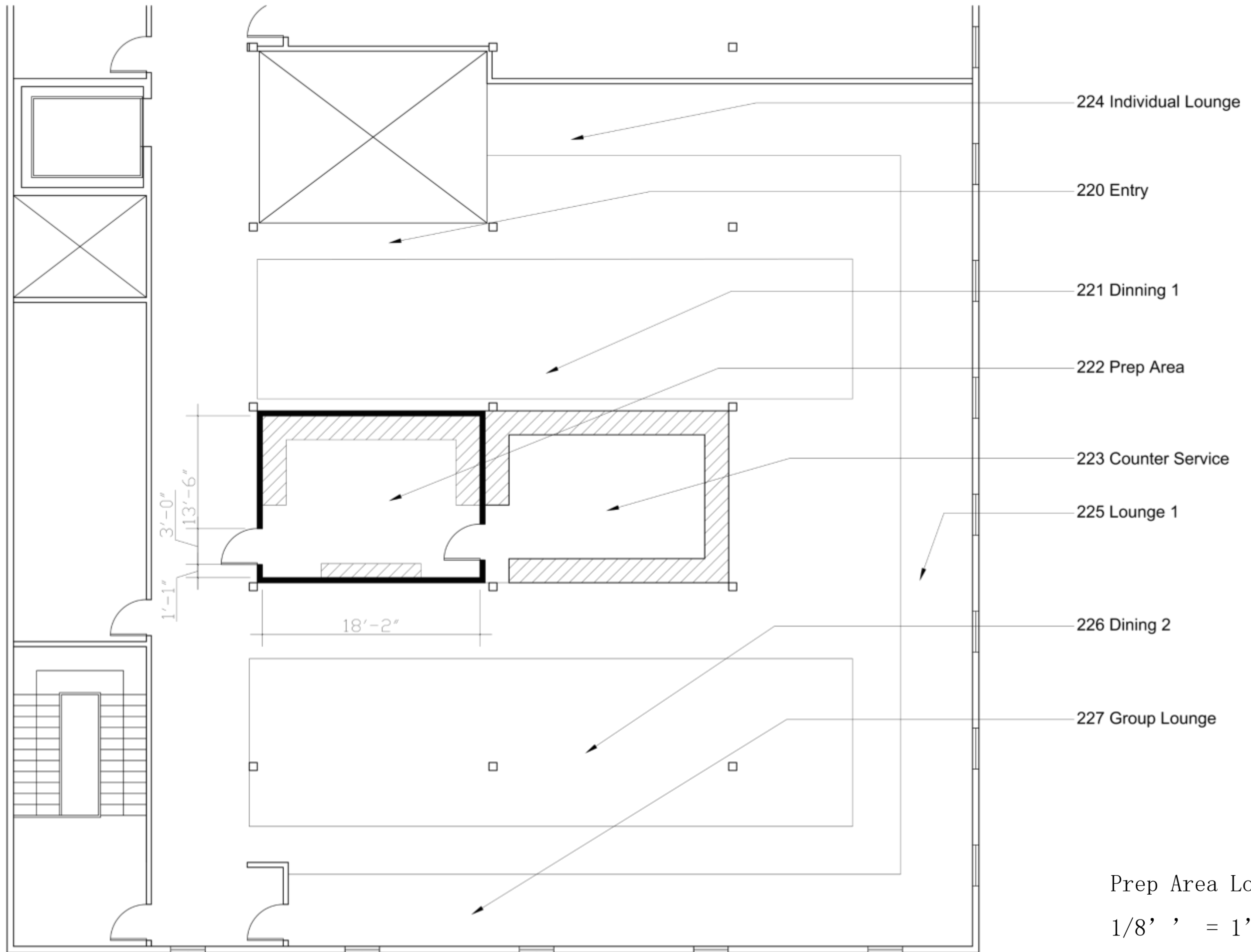

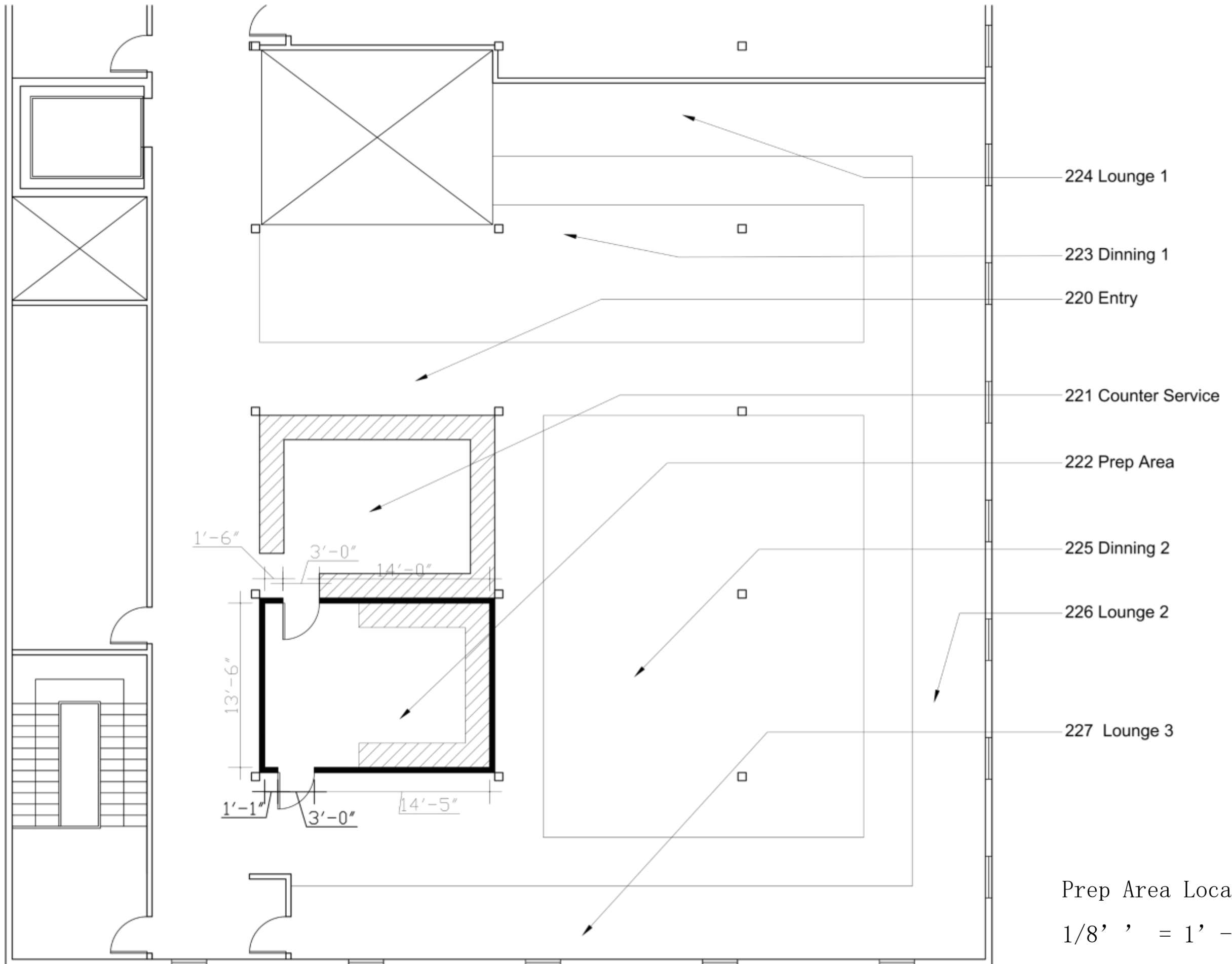

Prep Area Location 2

1/8' ' = 1' -0' '

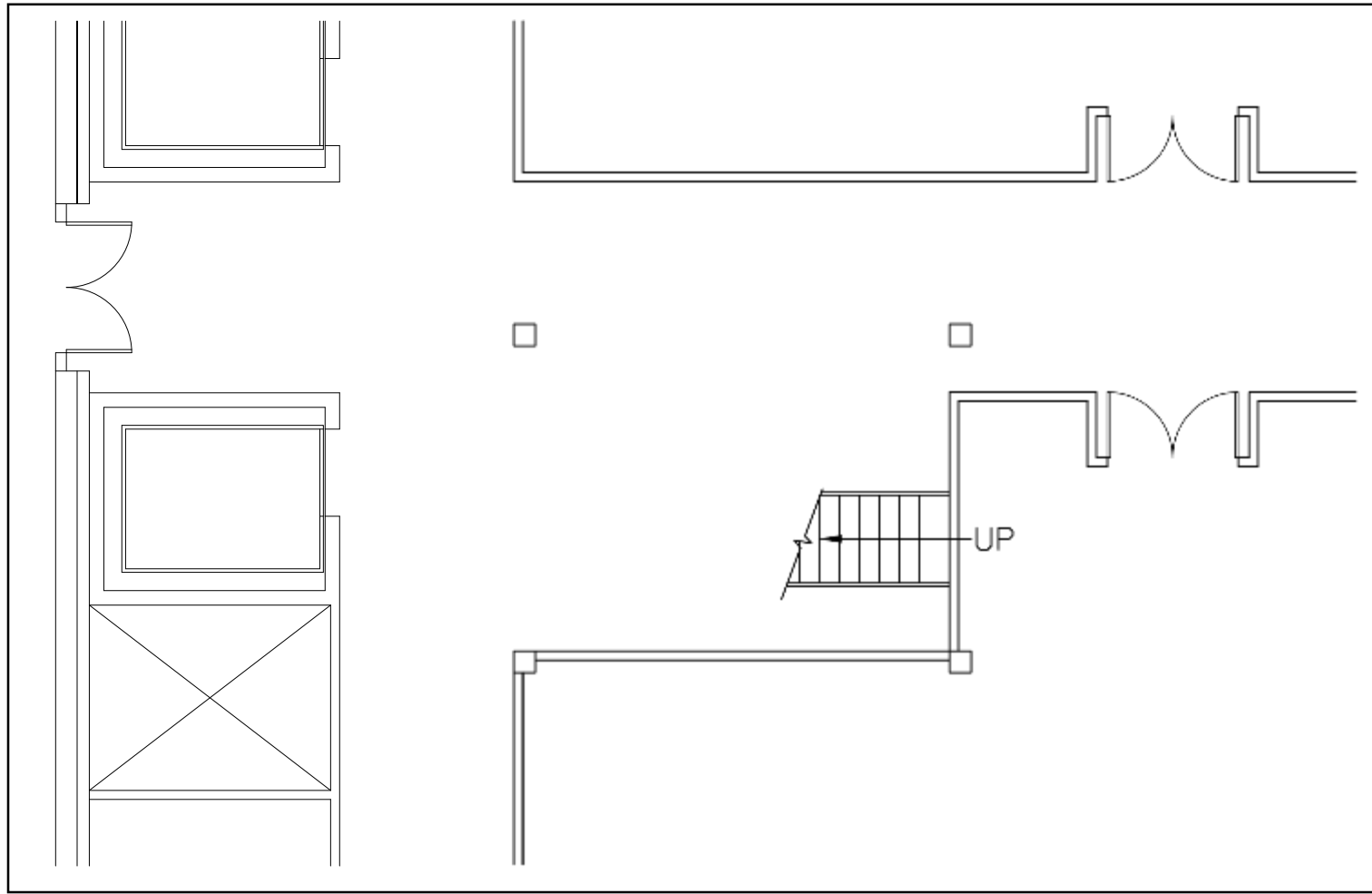

First Floor Plan

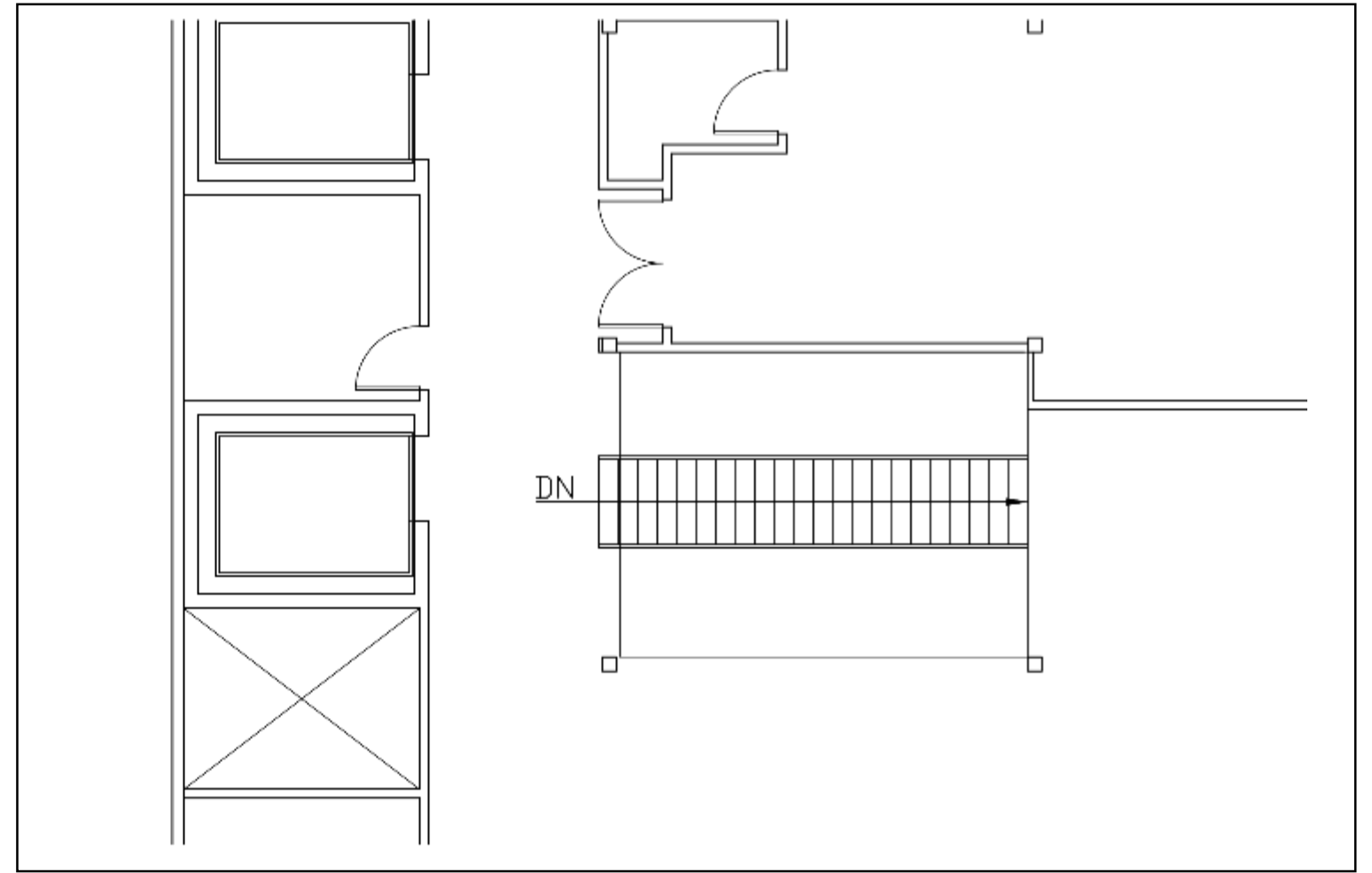

Second Floor Plan

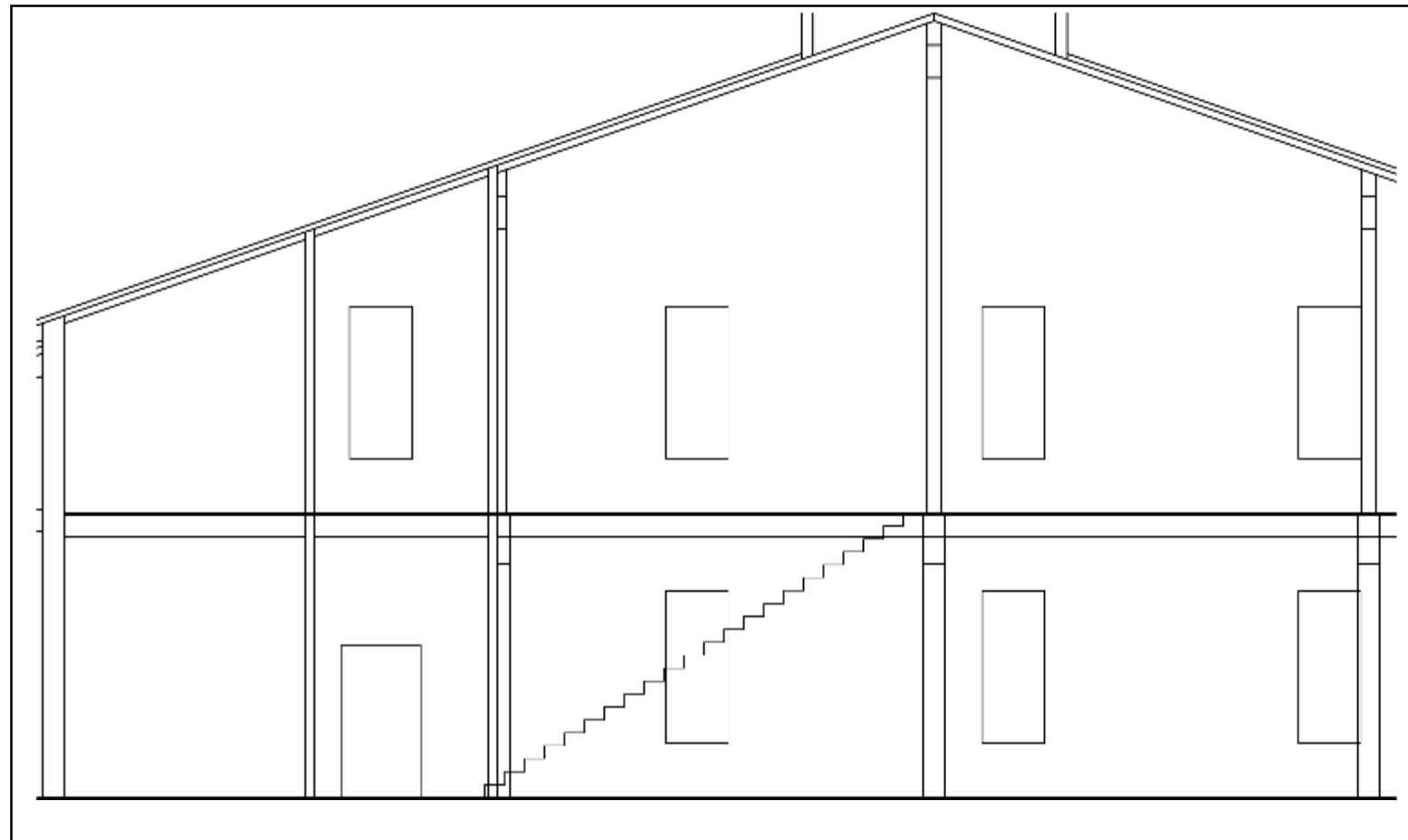

Section

Straight-Run Stairs
 $1/8'' = 1' - 0''$

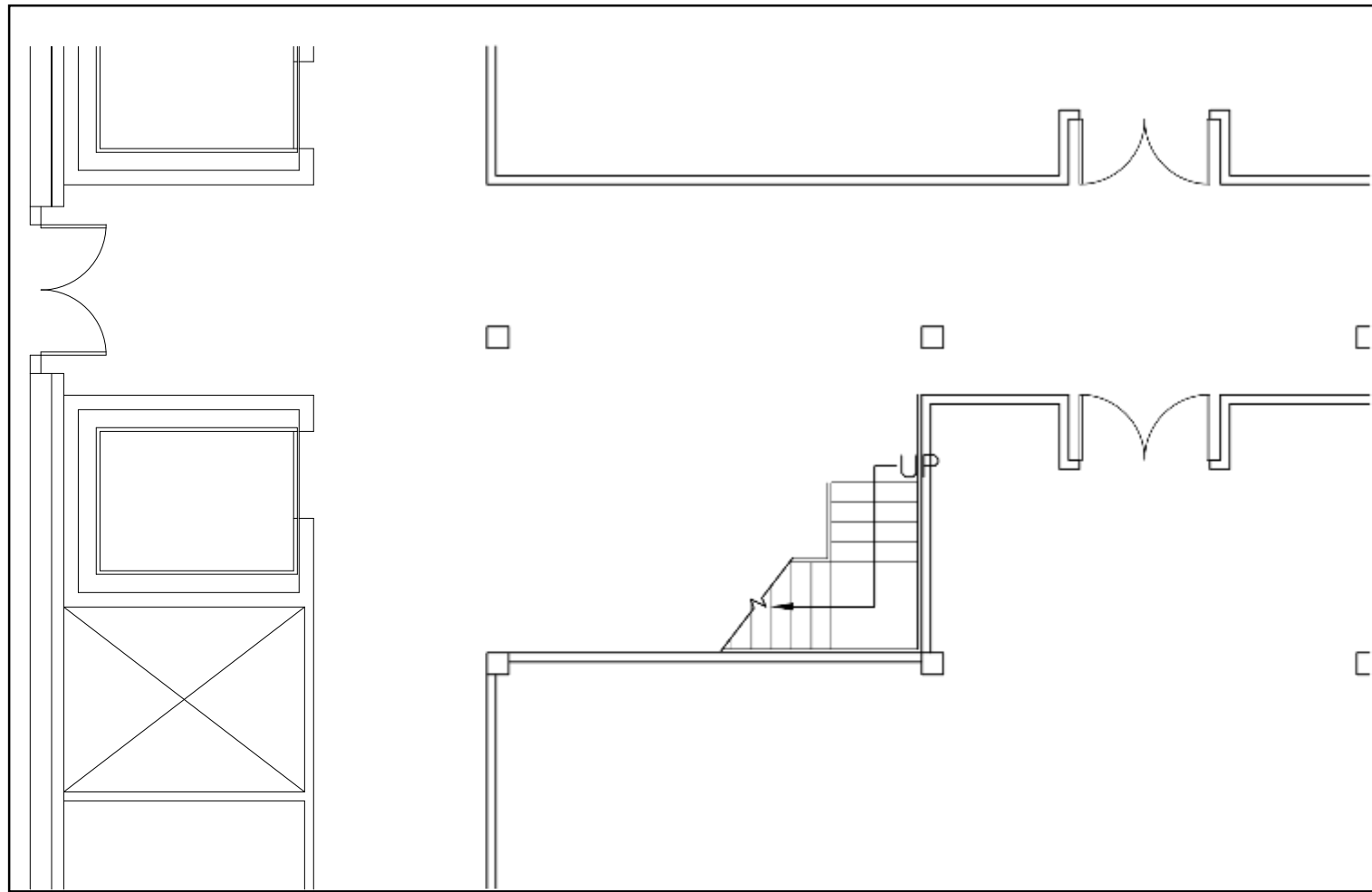

First Floor Plan

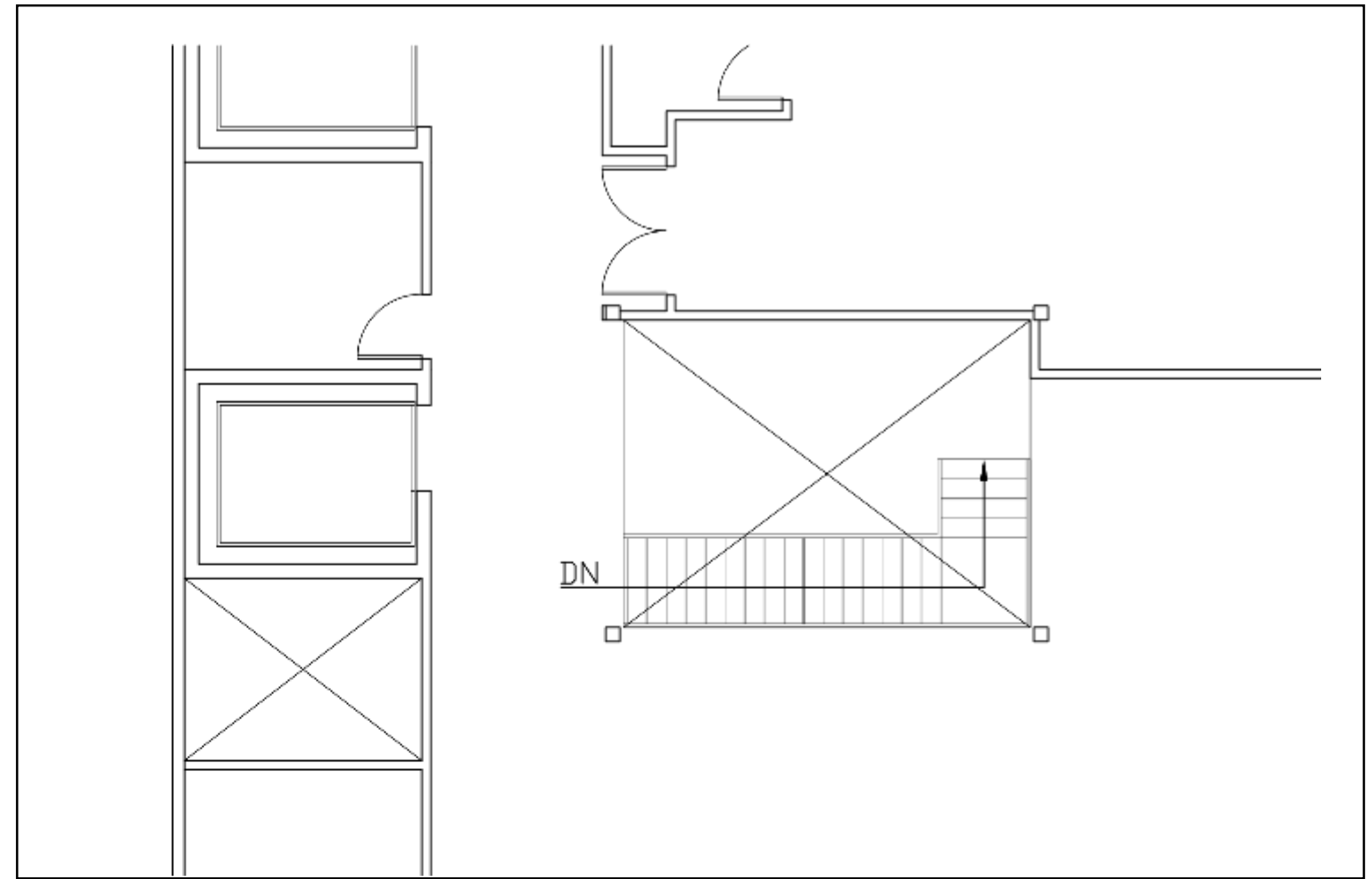

Second Floor Plan

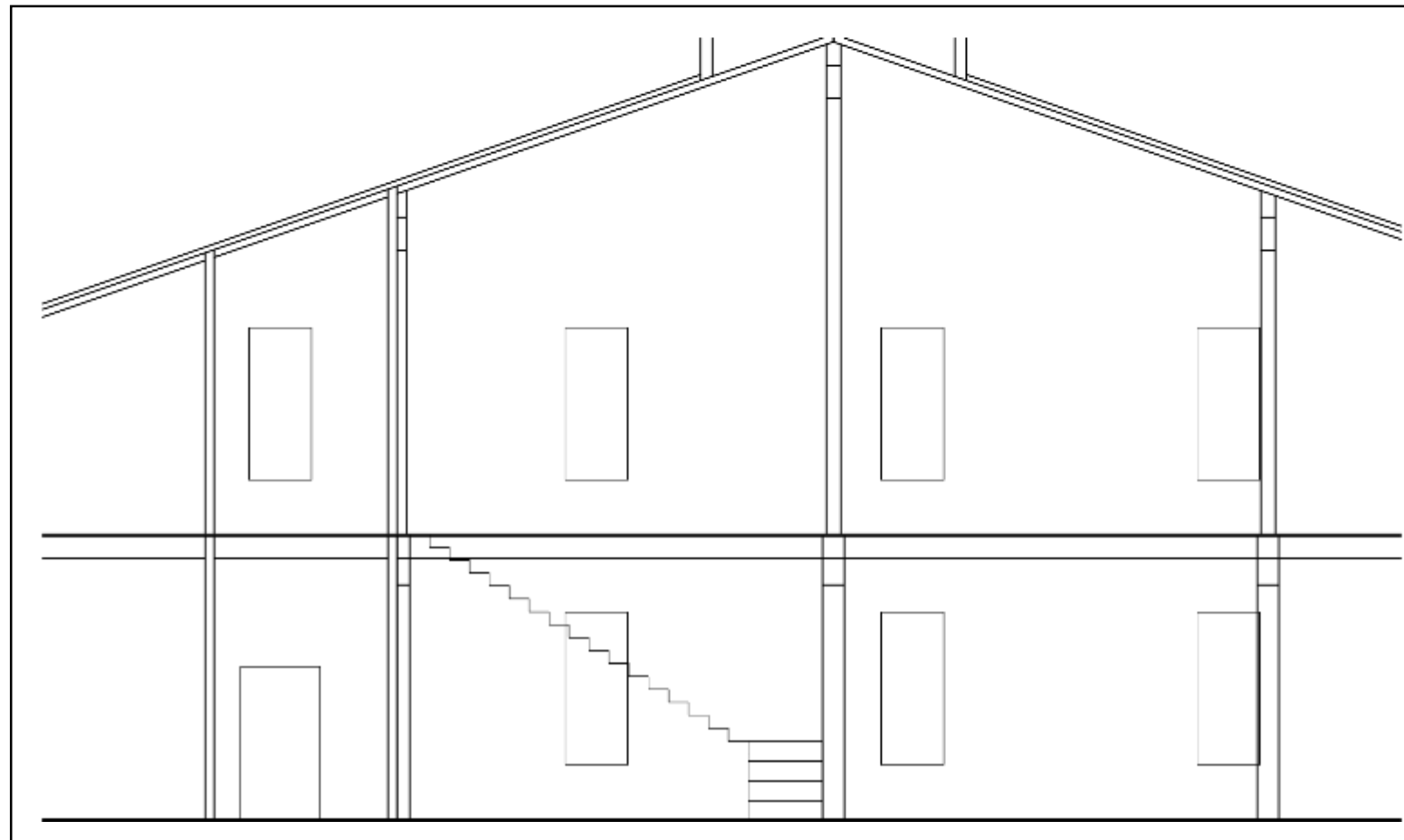

Section

L-Shaped Stairs

1/8' ' = 1' -0' '

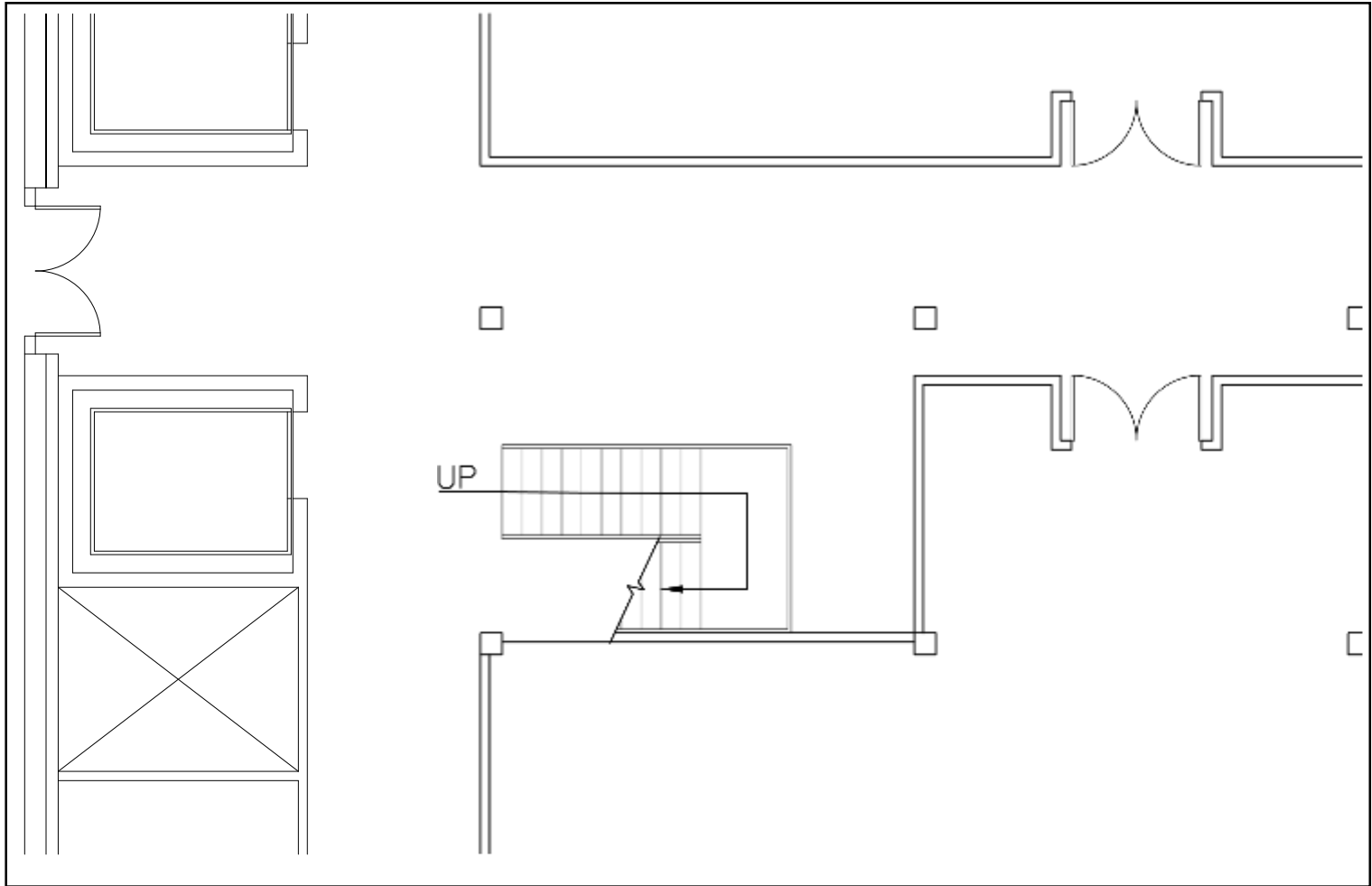

First Floor Plan

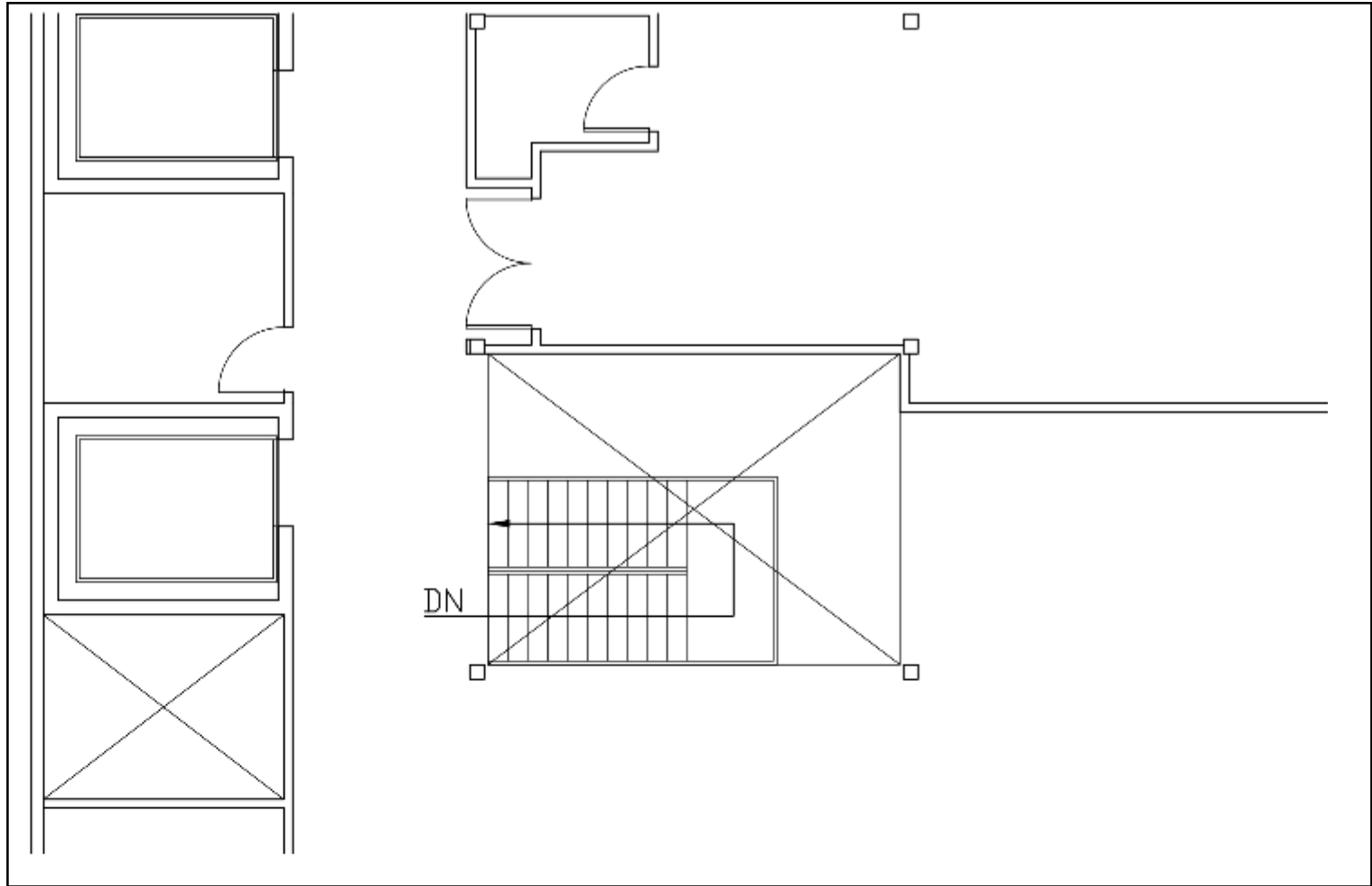

Second Floor Plan

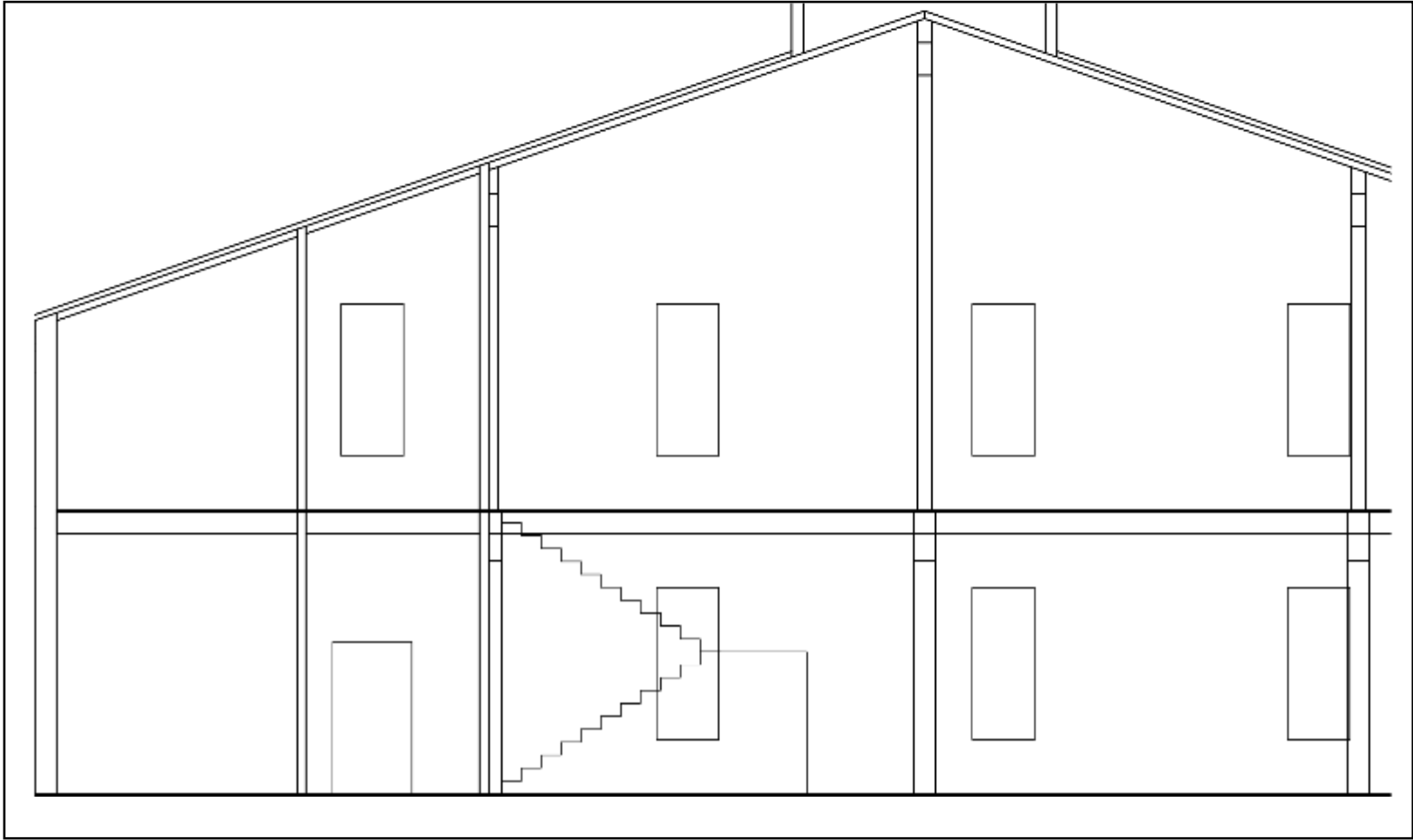

Section

Scissors Stairs

$1/8'' = 1'-0''$



Straight-Run Stairs



Straight-Run Stairs

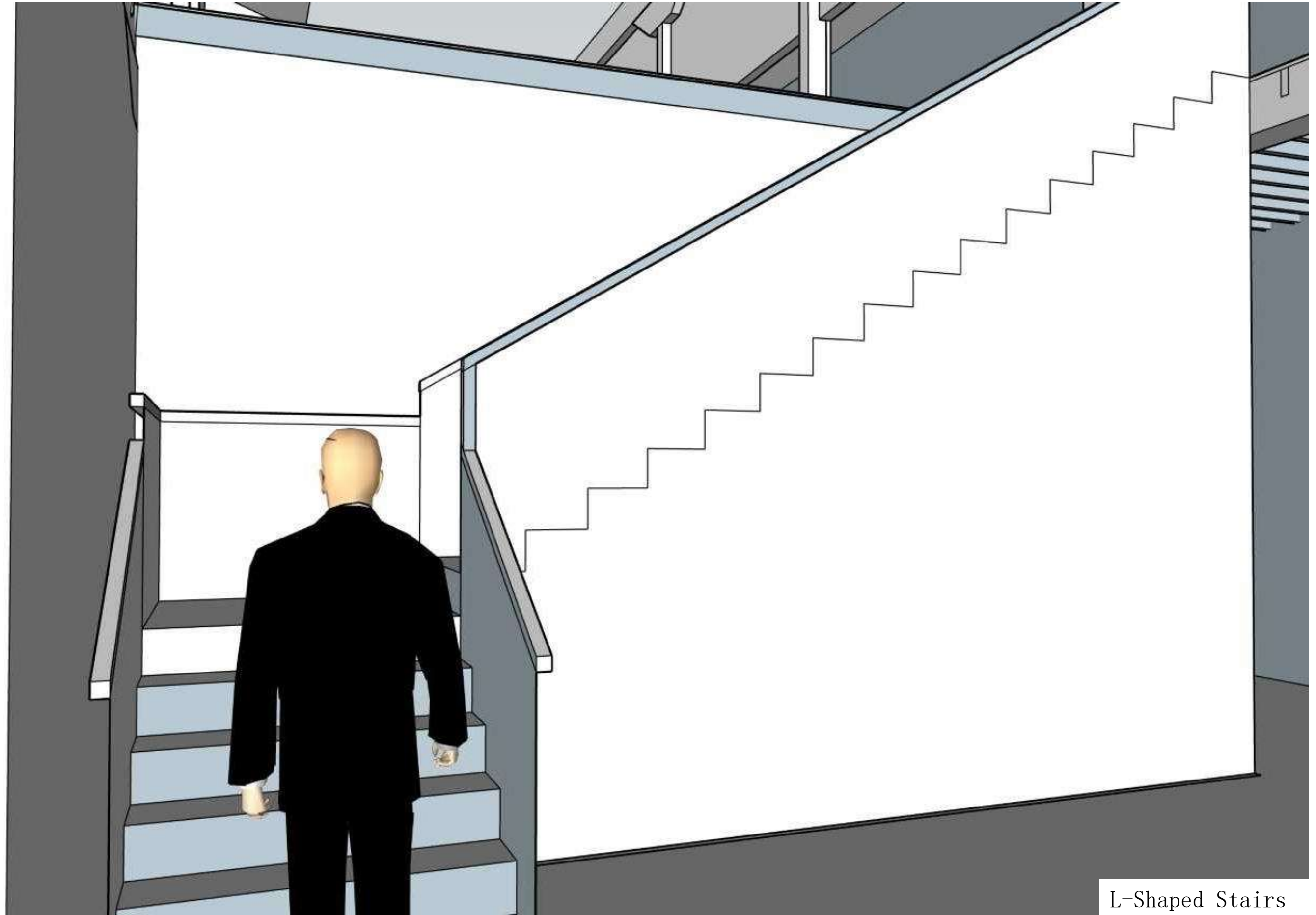

L-Shaped Stairs

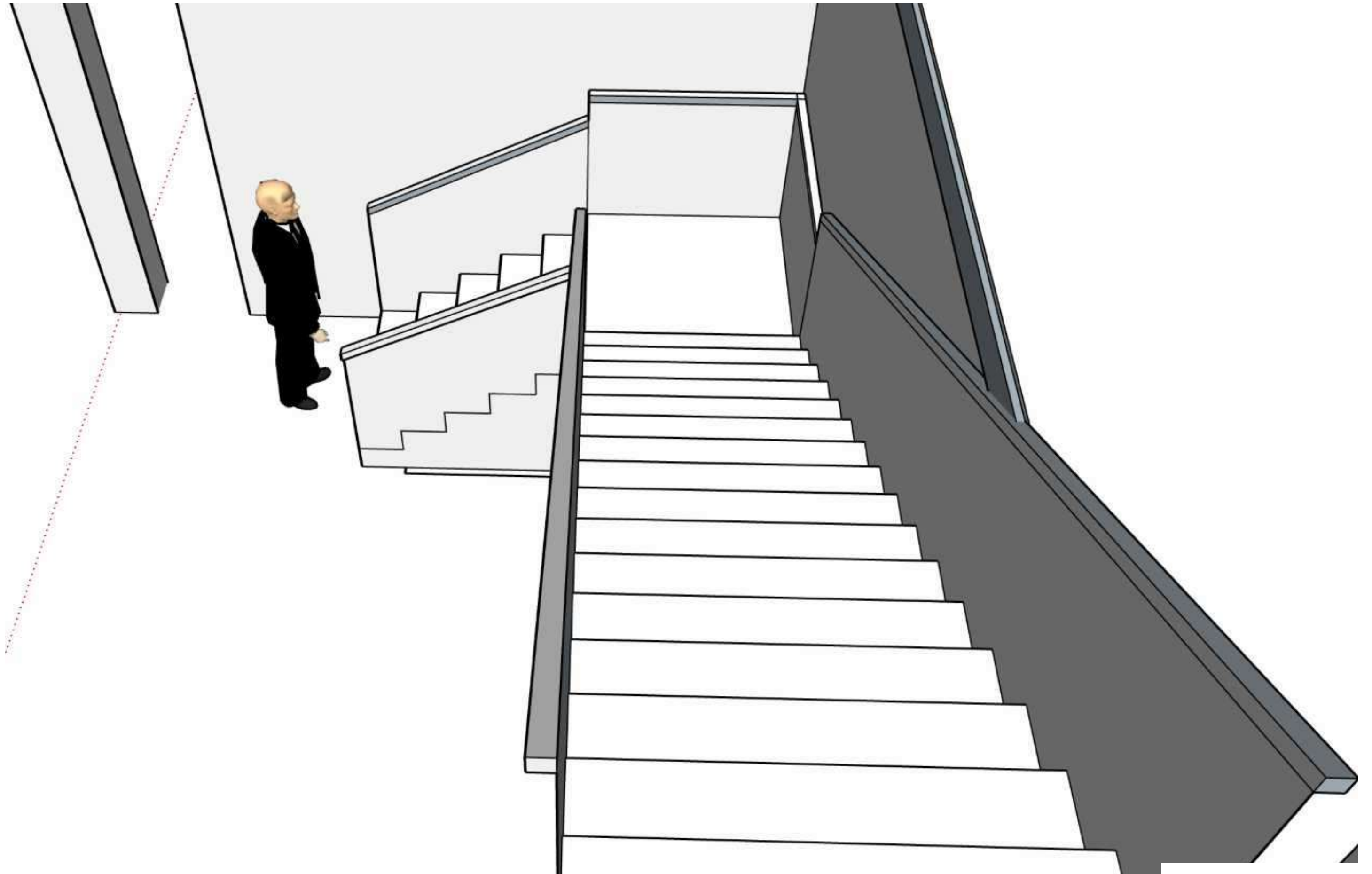

L-Shaped Stairs

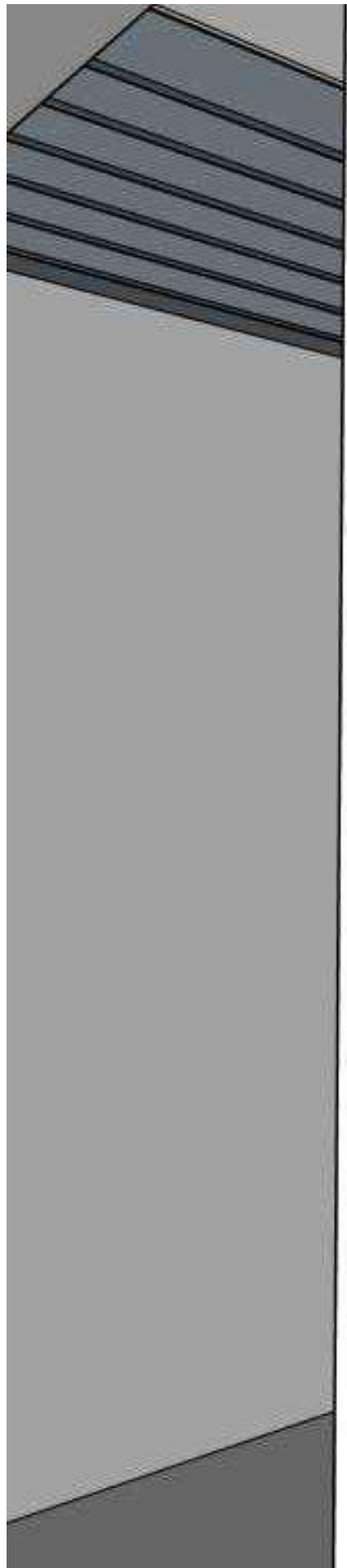

Scissors Stairs



Scissors Stairs

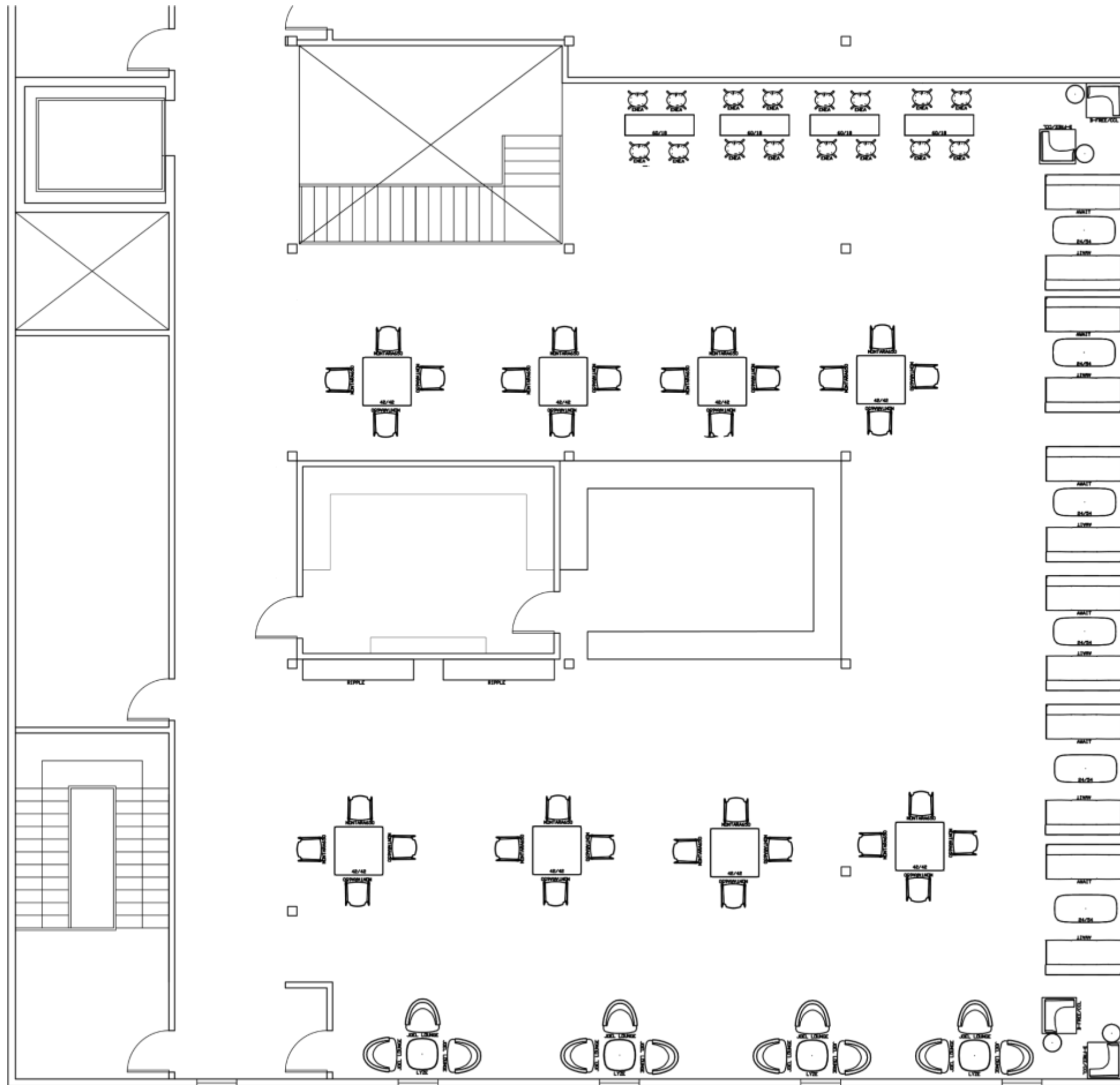

Furniture Plan 1
 106 Seats
 1/8' ' = 1' -0' '

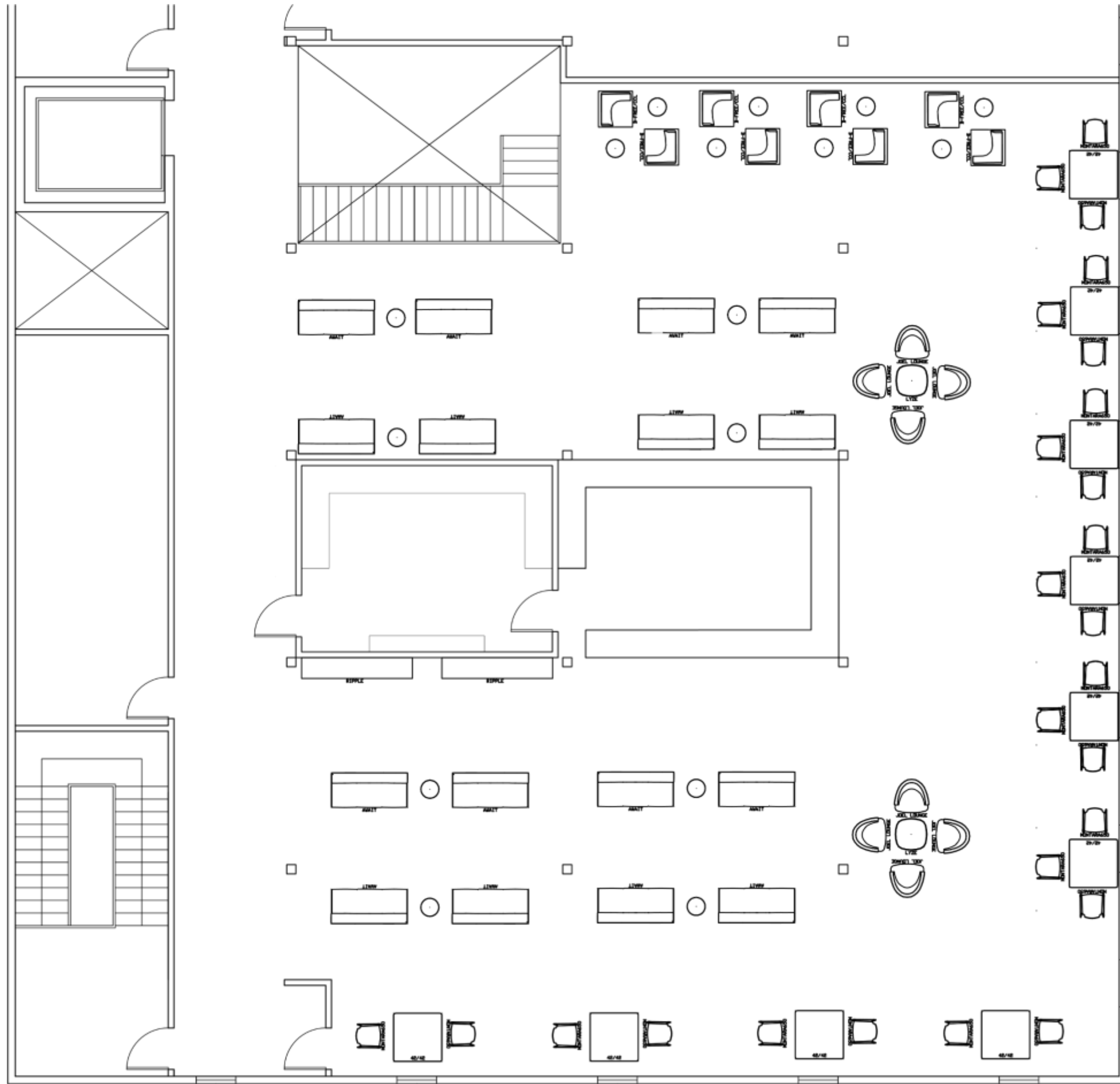

Furniture Plan 2
 90 Seats
 1/8' ' = 1' -0' '

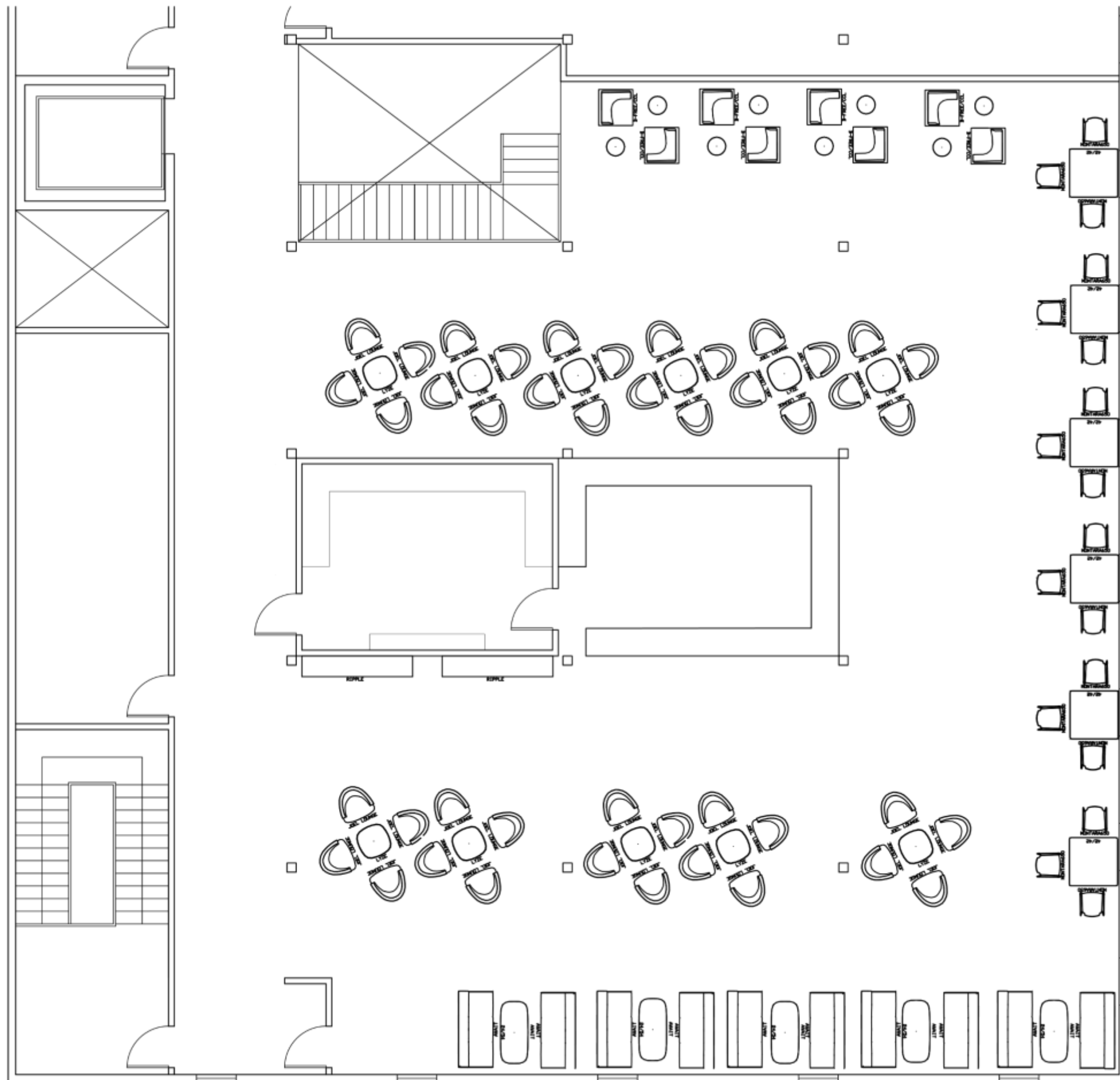

Furniture Plan 3

100 Seats

1/8" = 1'-0"

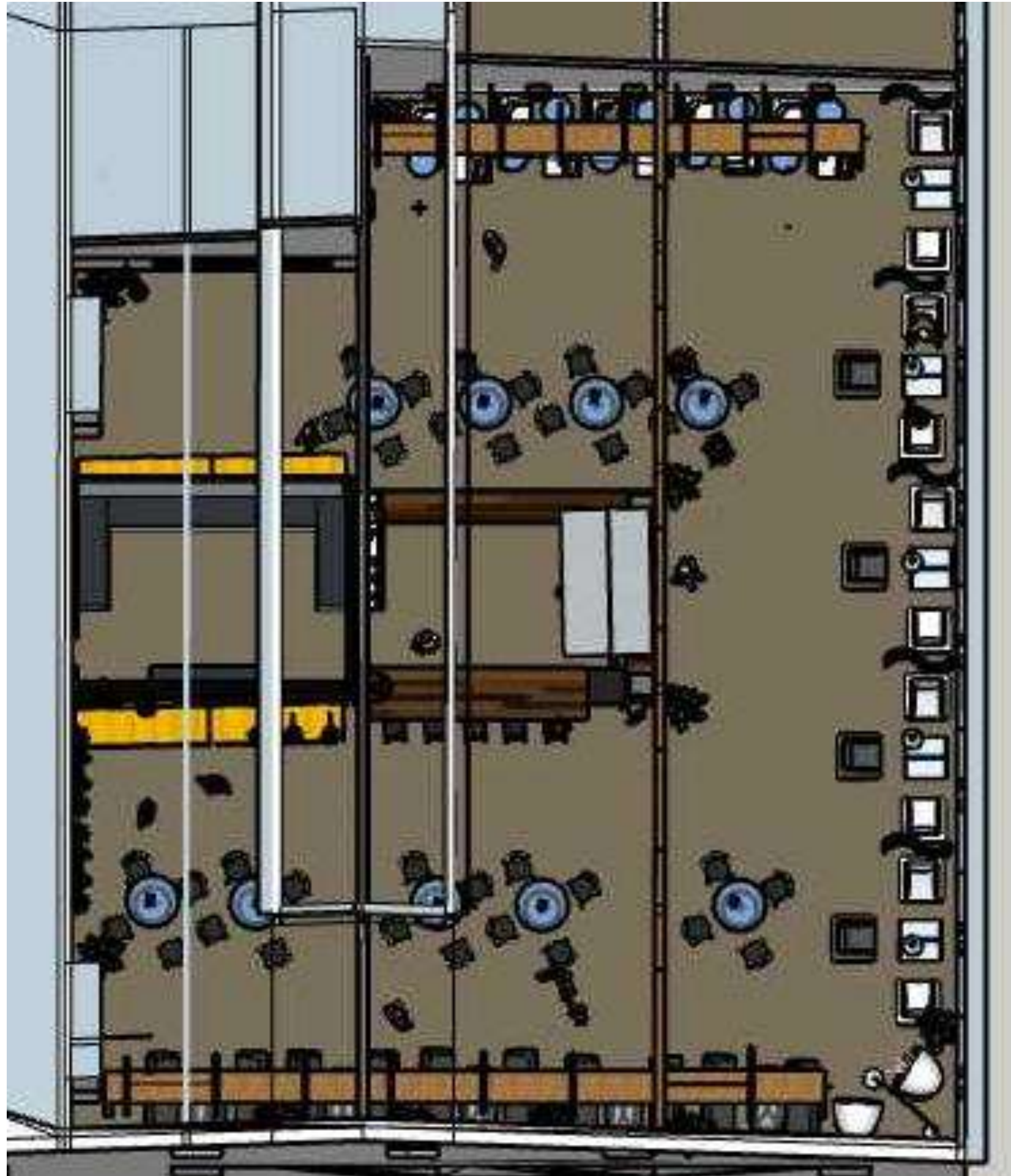

Sketchup Floor Plan

Link to Sketchup Vimeo: <https://vimeo.com/300435675>