

Prototyping & Testing

Portolio3

Fall Interior Design Studio 001

Julien Wohlgemuth

AutoCAD Preliminary Plan Sketches

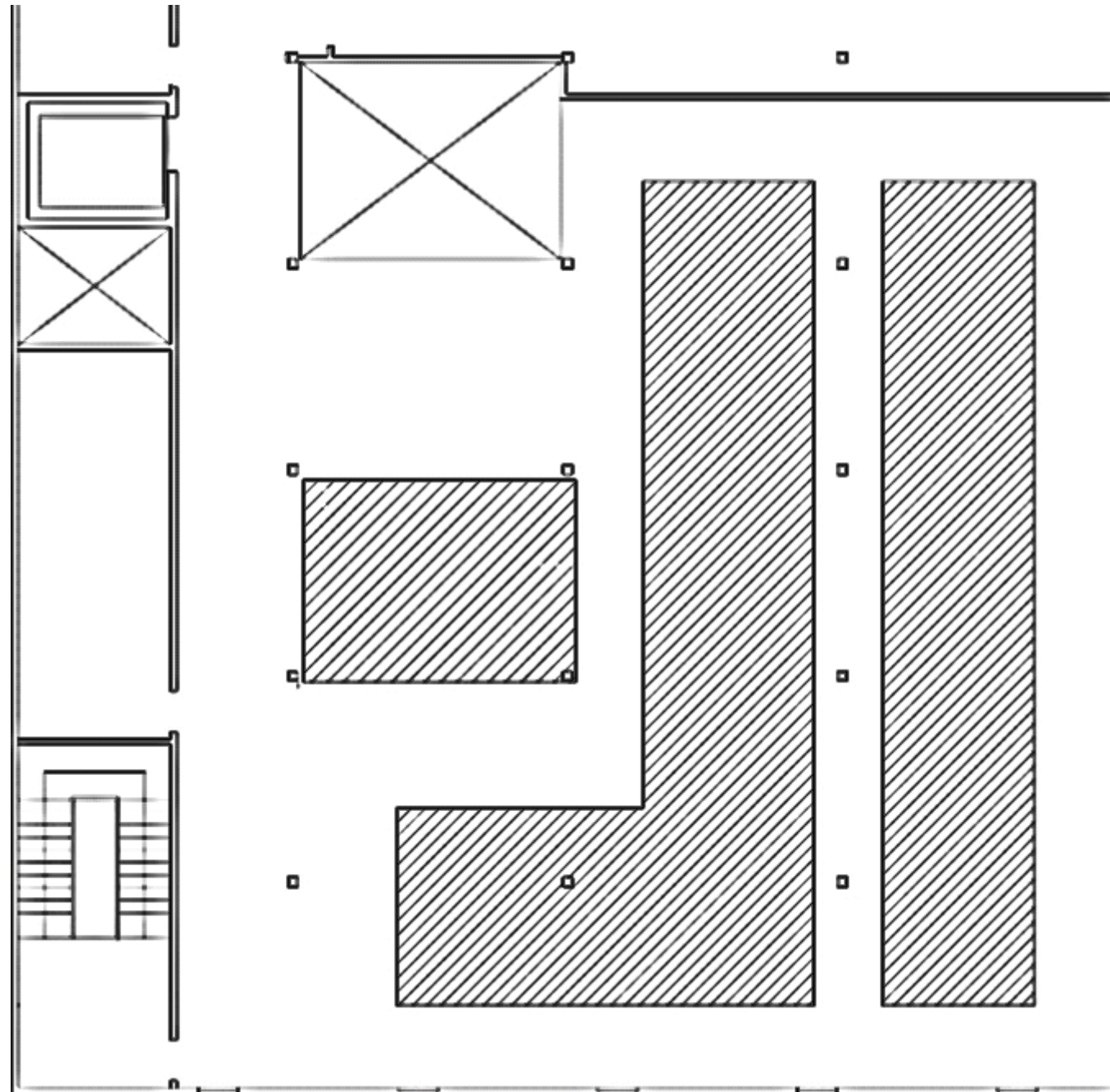

1/8" = 1'0"

Circulation Layouts

AutoCAD Preliminary Plan Sketches

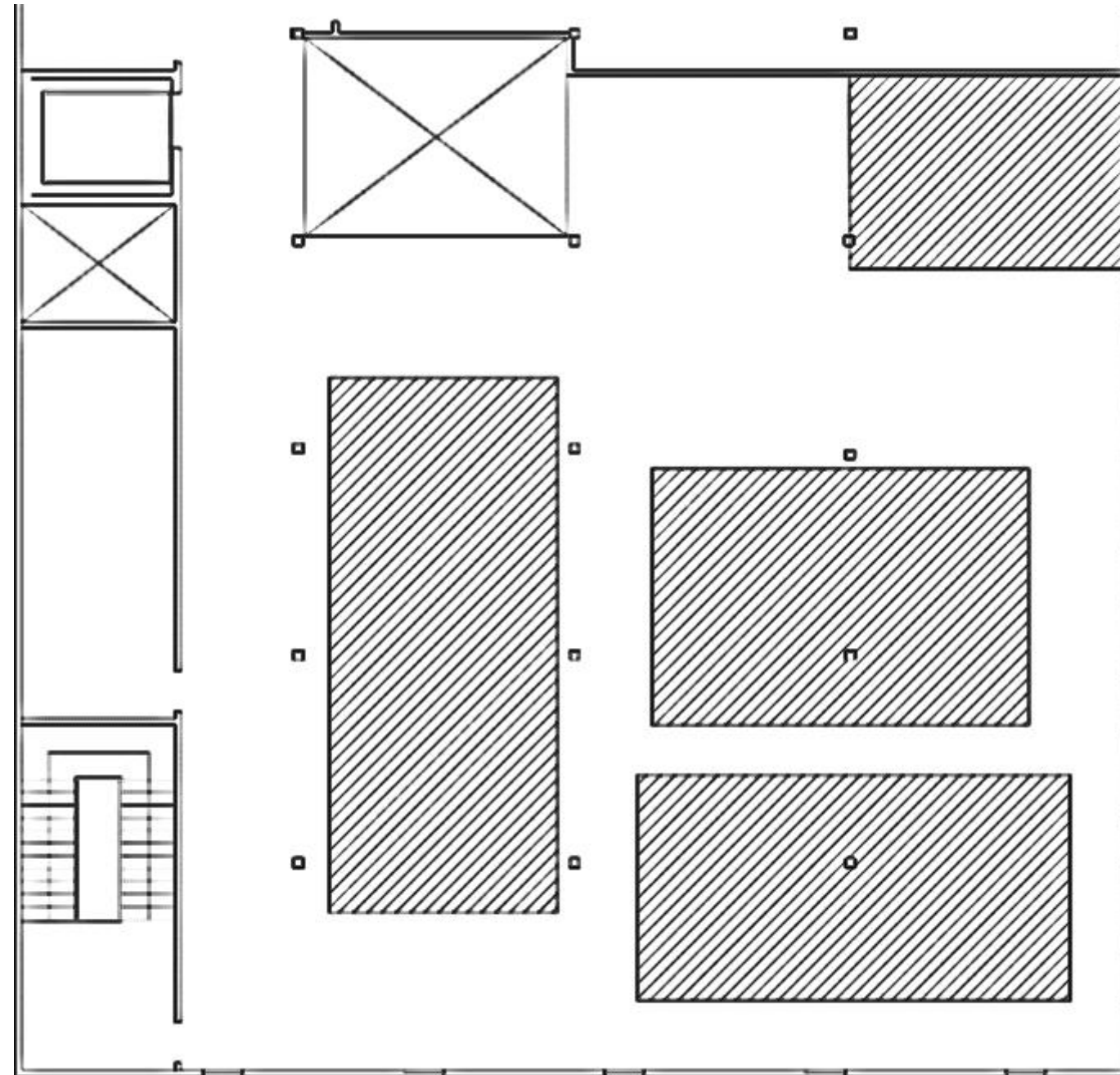

1/8" = 1'0"

Circulation Layouts

AutoCAD Preliminary Plan Sketches

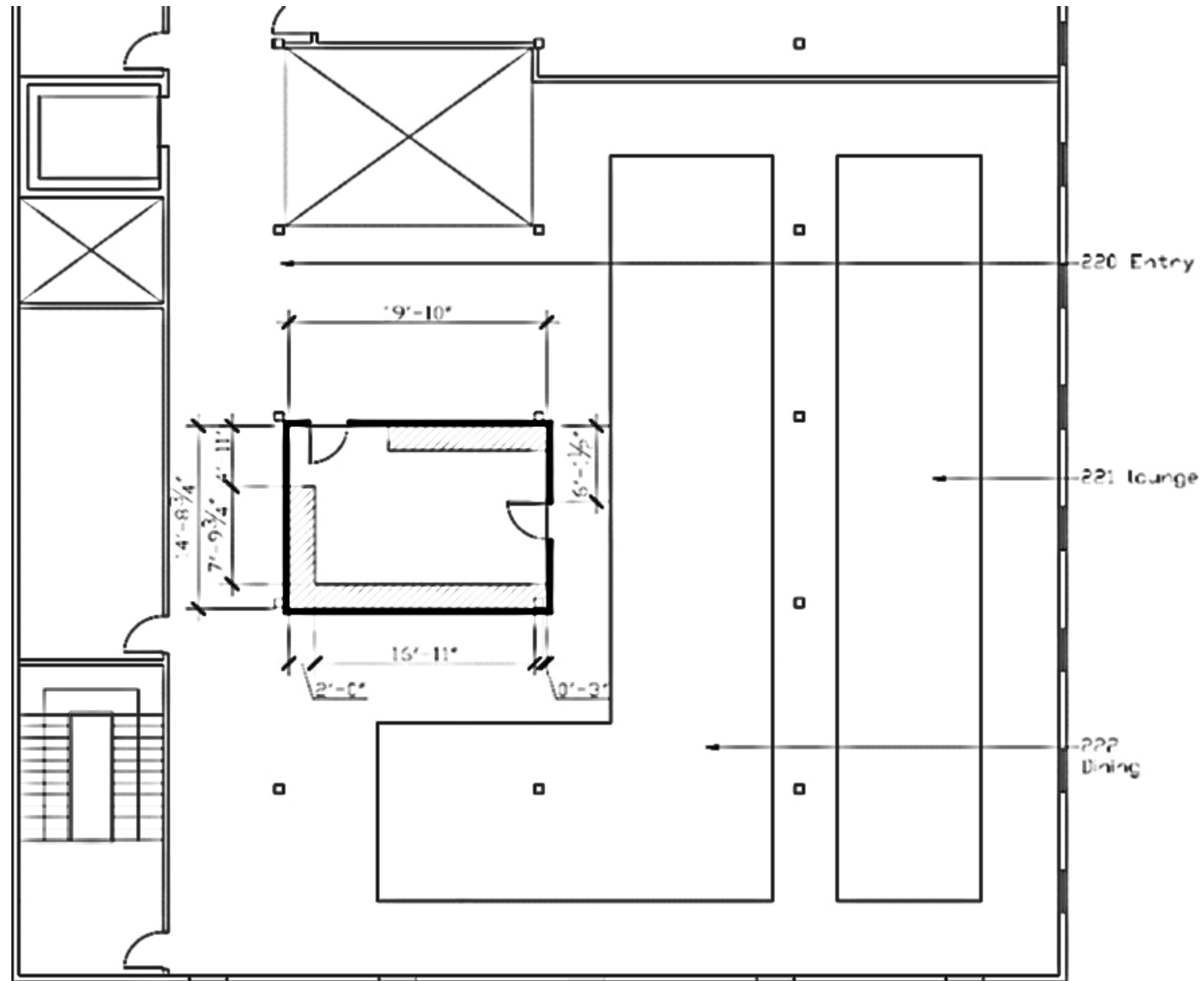

1/8" = 1'0"

Prep Area/Service Counter Location 1

AutoCAD Preliminary Plan Sketches

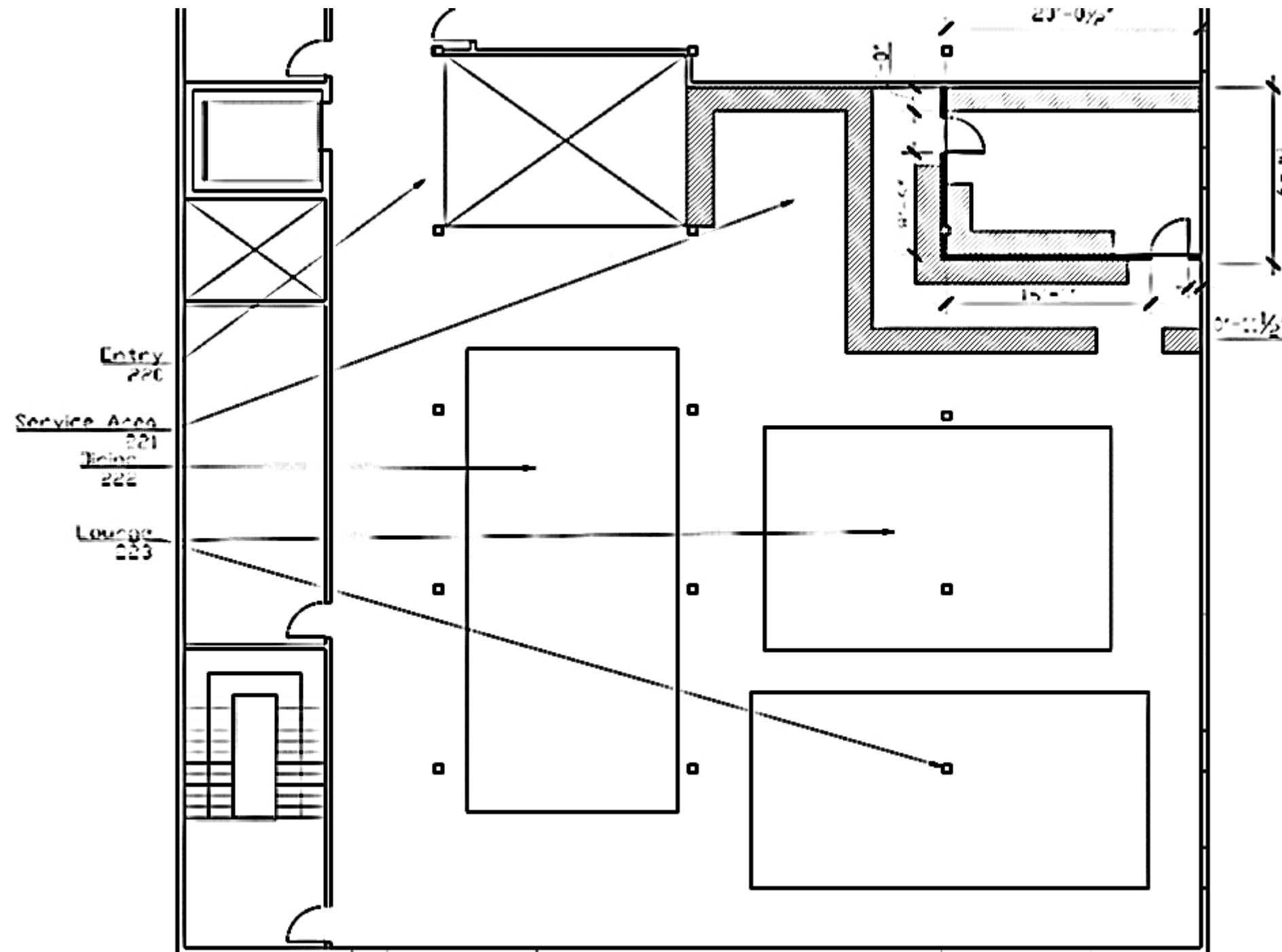

1/8" = 1'0"

Prep Area/Service Counter Location 2

Stair Design: AutoCAD Plans and Sections

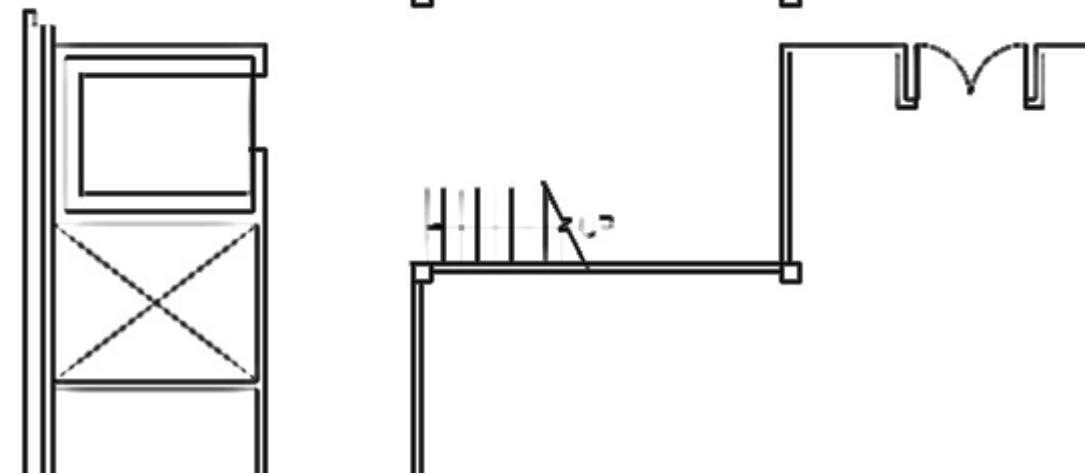
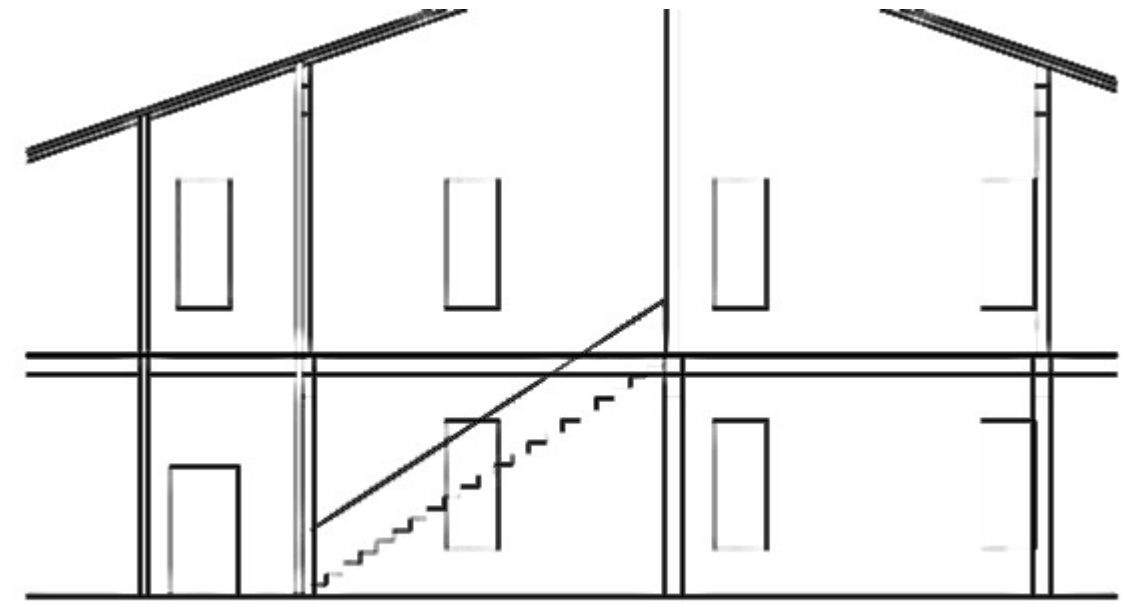
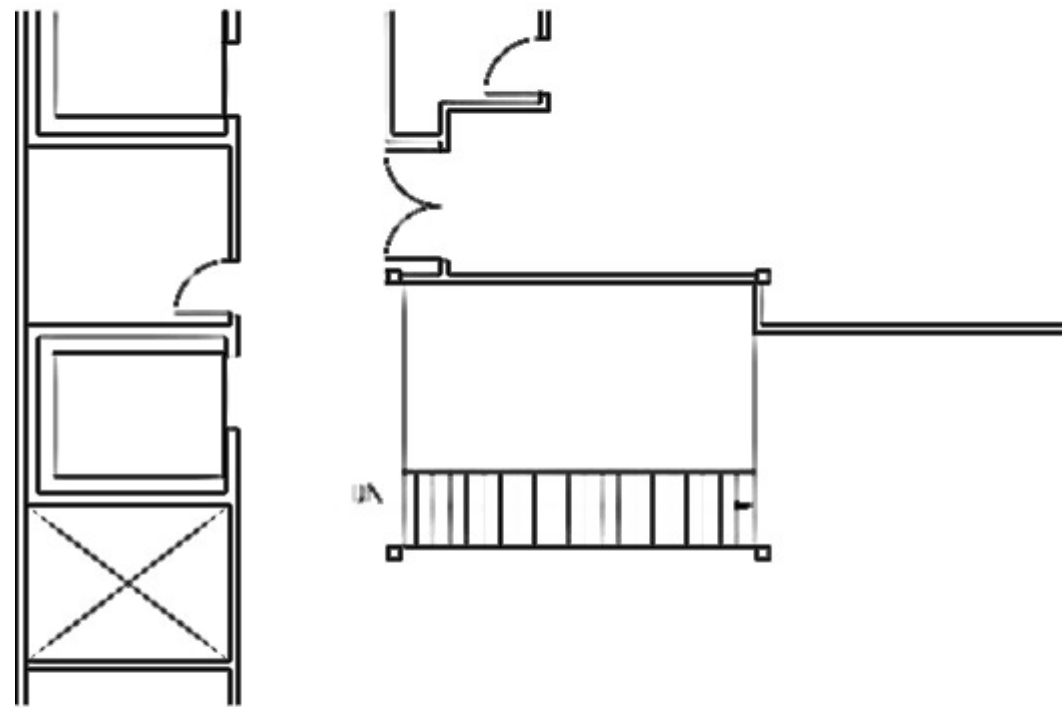

1/8" = 1'0"

Straight-Run Stair

Stair Design: AutoCAD Plans and Sections

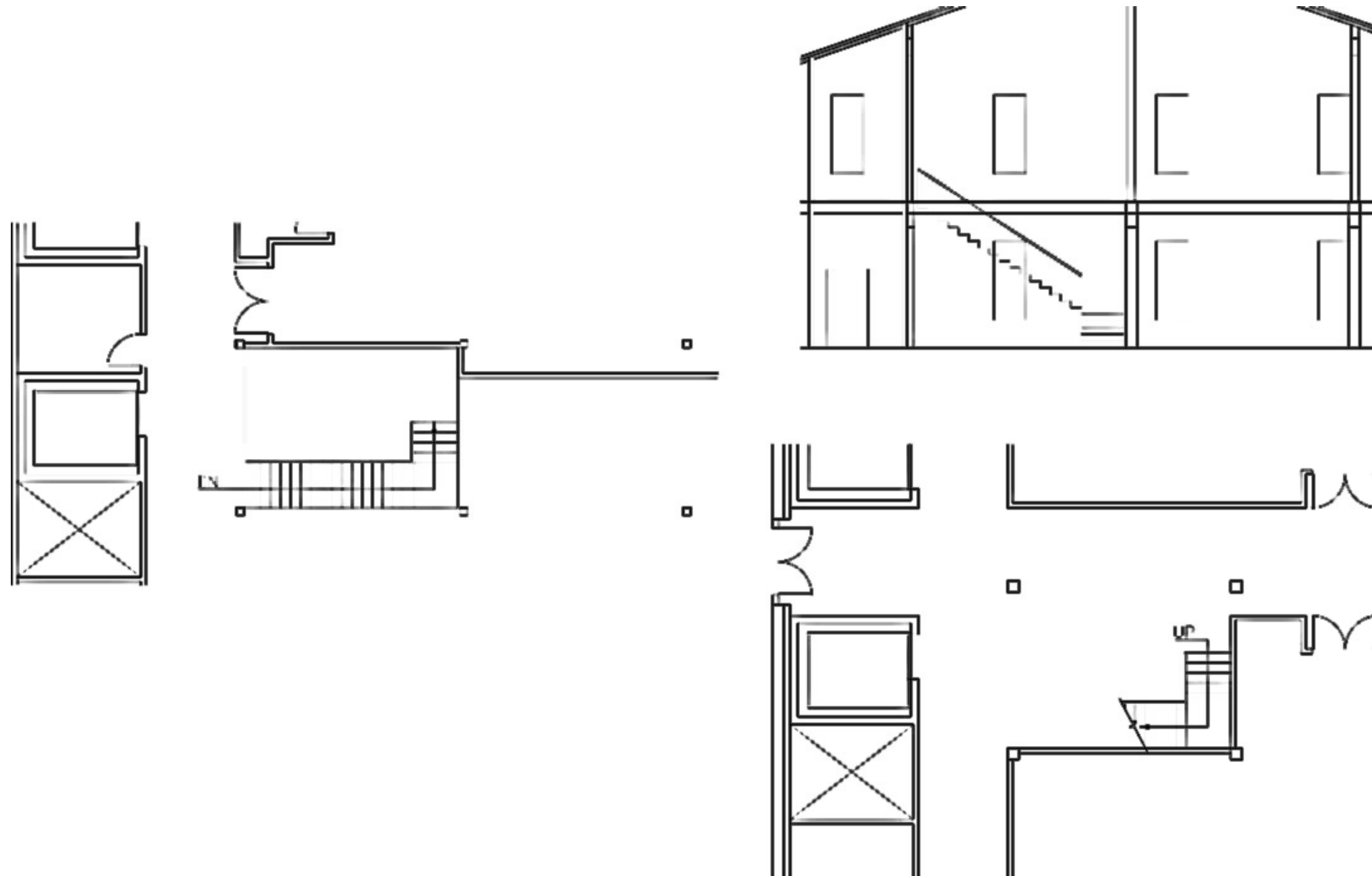

1/8" = 1'0"

L-Shaped Stair

Stair Design: AutoCAD Plans and Sections

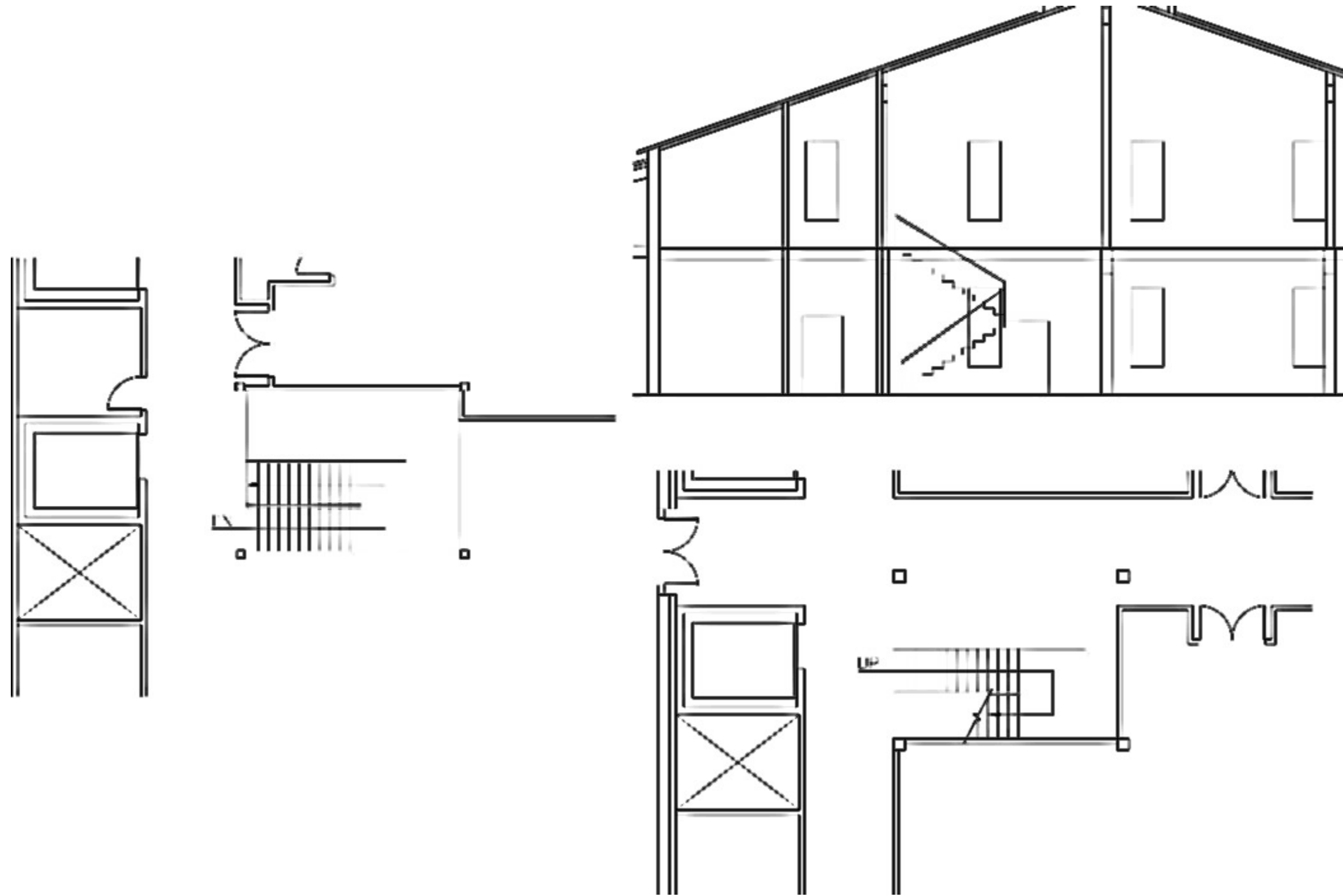

1/8" = 1'0"

Scissor Stair

Stair Design

SketchUp Perspectives

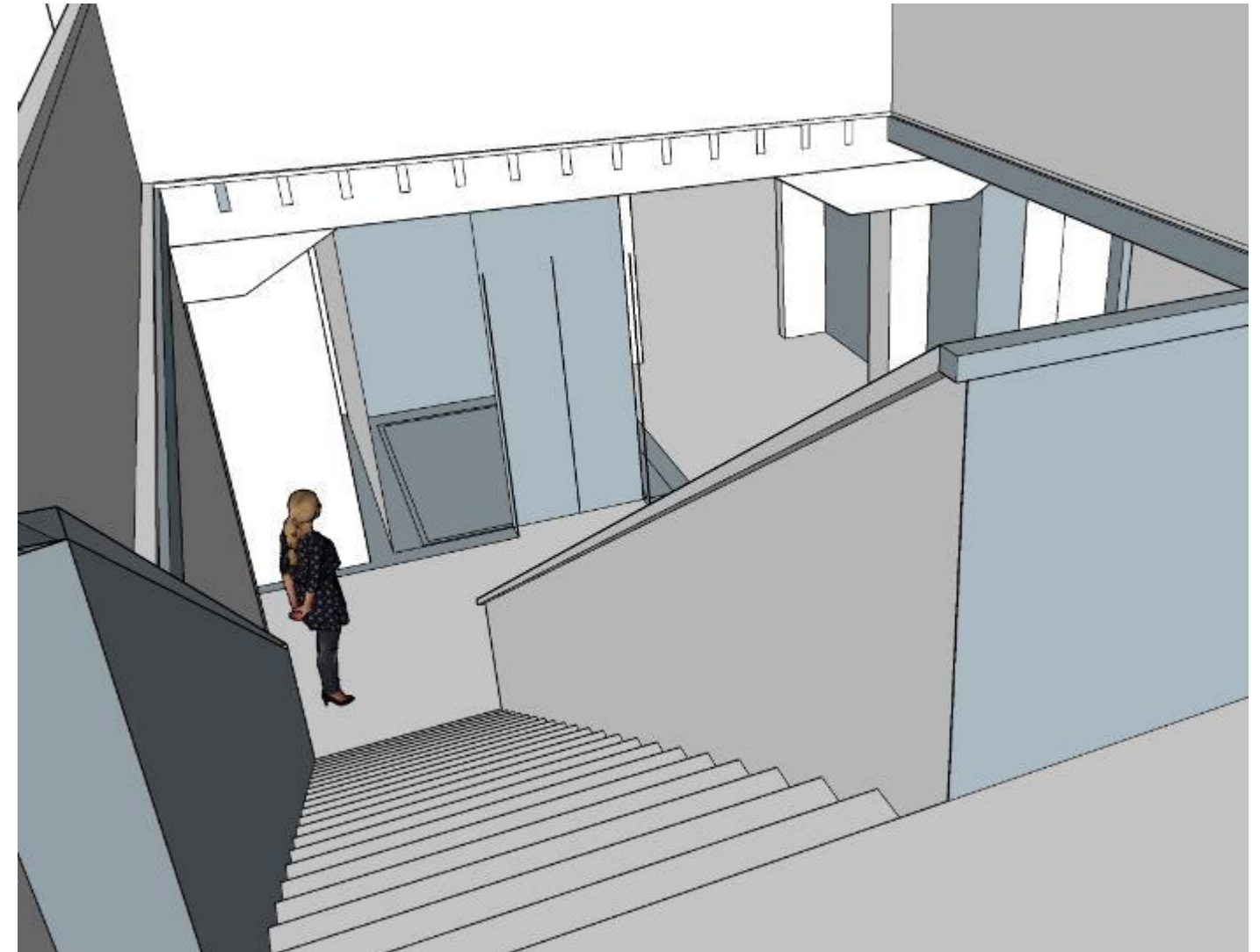

Straight-Run Stair

Stair Design
SketchUp Perspectives



L-Shaped Stair

Stair Design
SketchUp Perspectives

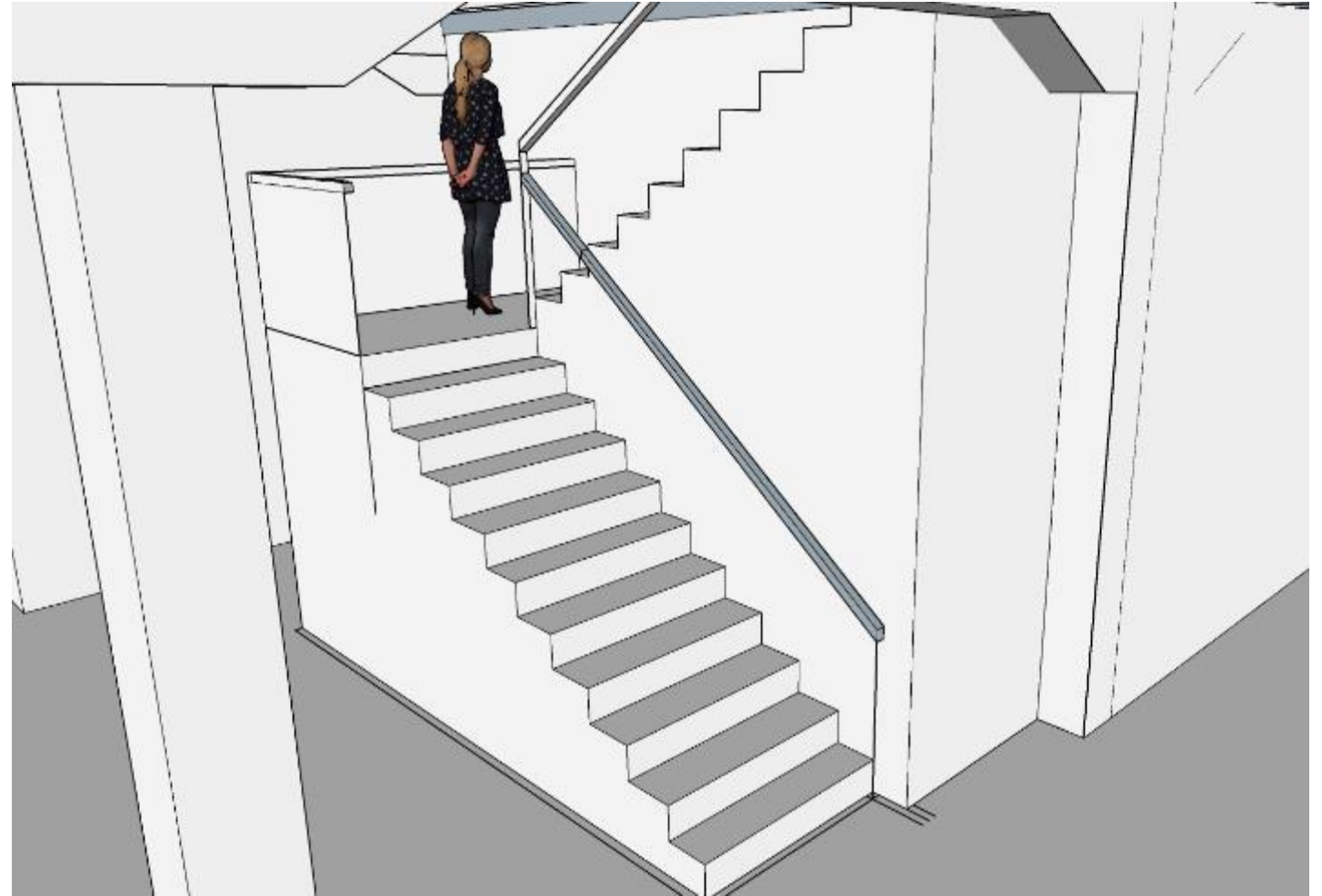

Scissor Stair

AutoCAD Furniture Plan 1

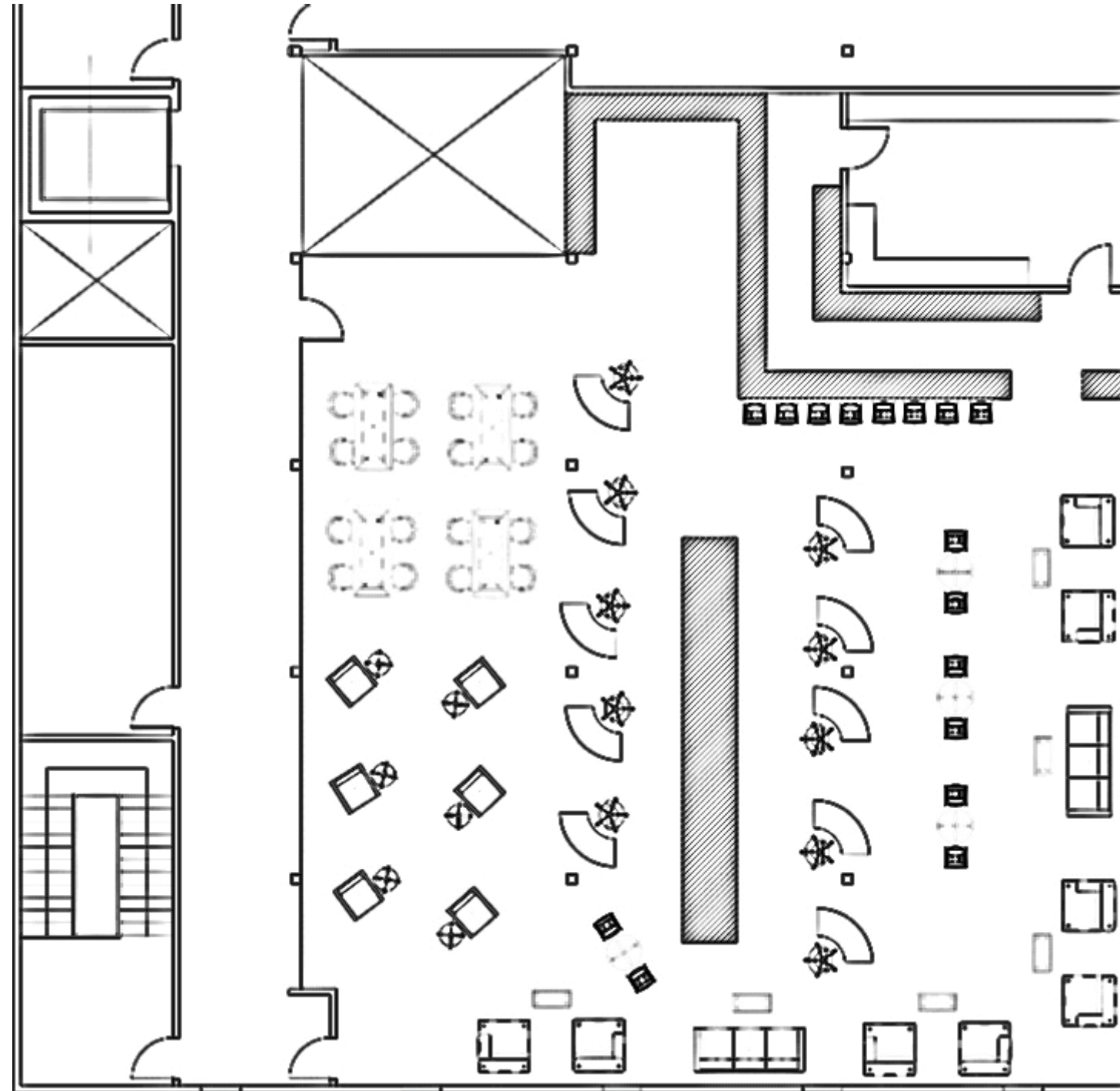

1/8" = 1'0"

62 Seats

AutoCAD Furniture Plan 2

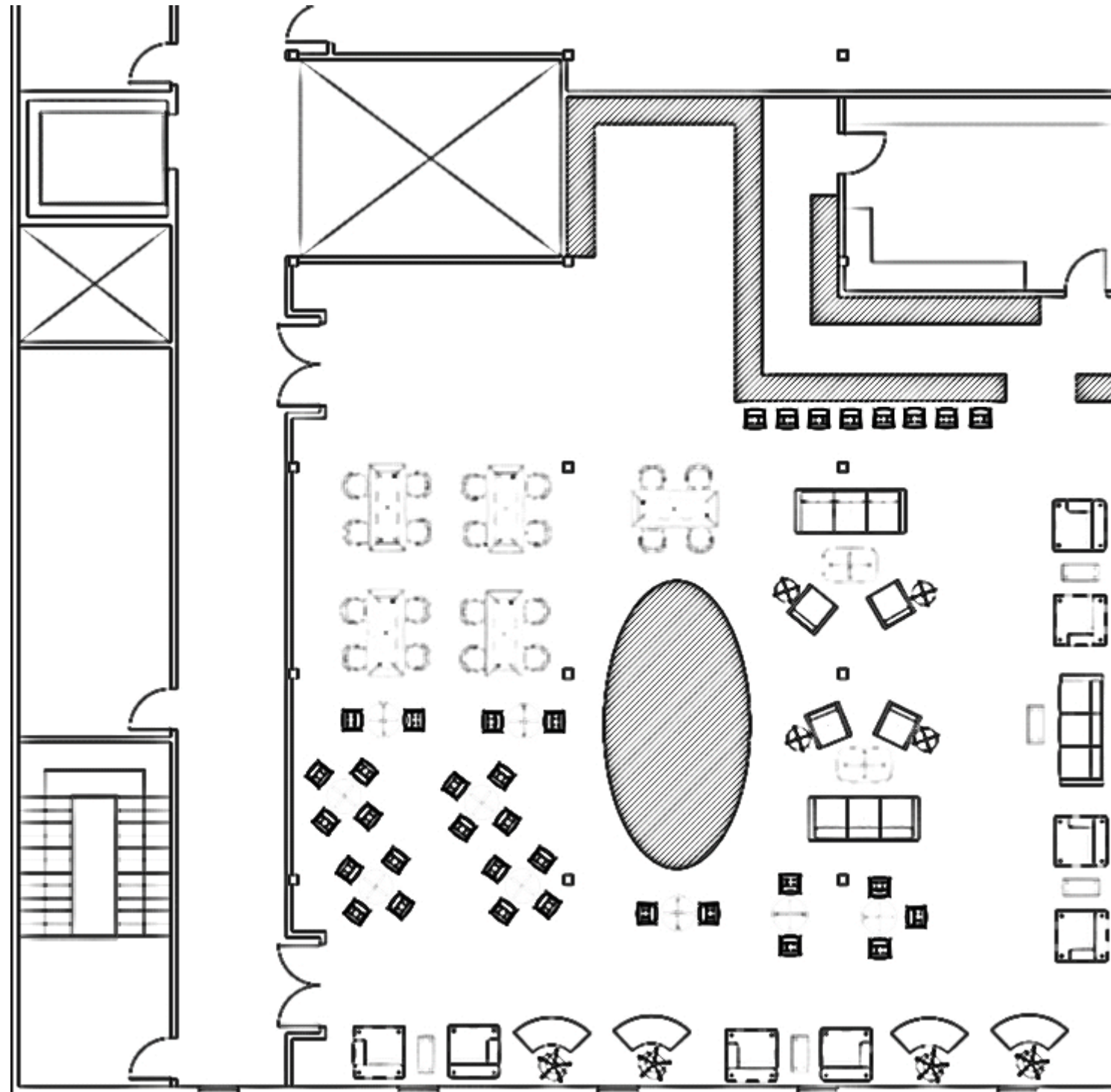

1/8" = 1'0"
80 Seats

AutoCAD Furniture Plan 3

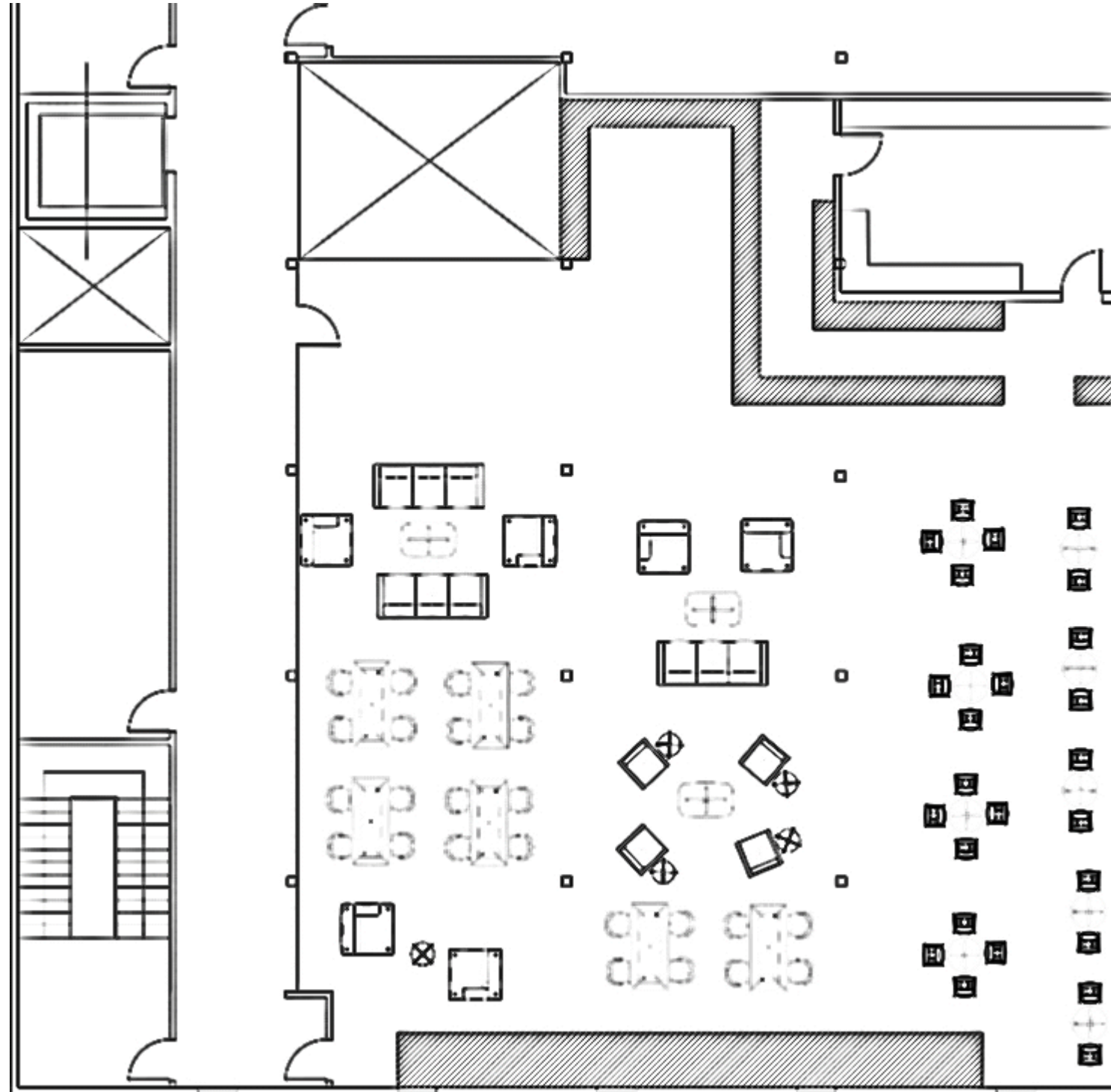

1/8" = 1'0"

95 Seats

SketchUp Model

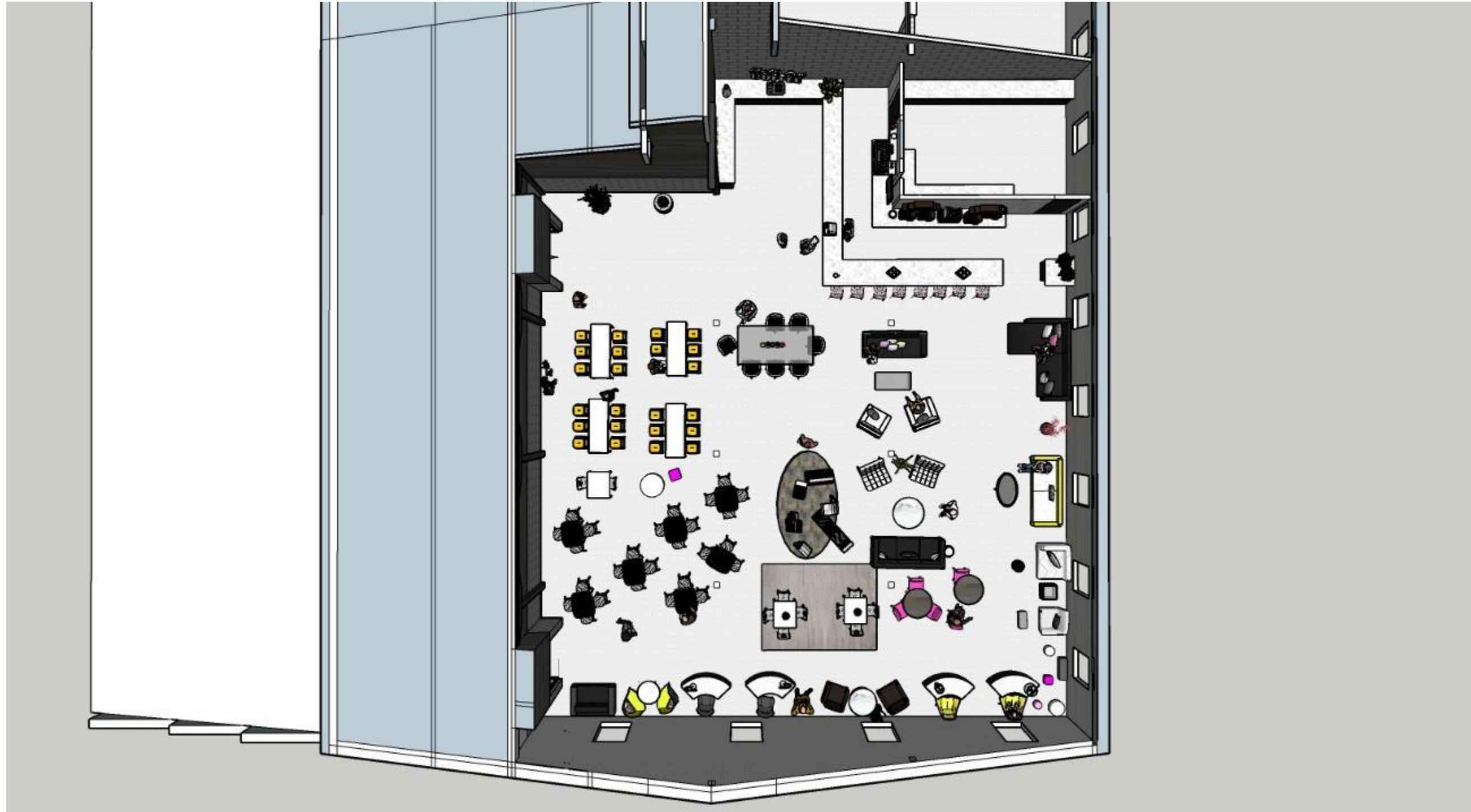

Final Furniture Layout- 96 Seats

SketchUp Walkthrough

<https://vimeo.com/user91120678/review/299729202/1e4409dbc3>