



Elizabeth Brown

IDSN 2102 F19

Portfolio Two

Elizabeth Brown

IDSN 2102 F19

Pathway & Dimension One

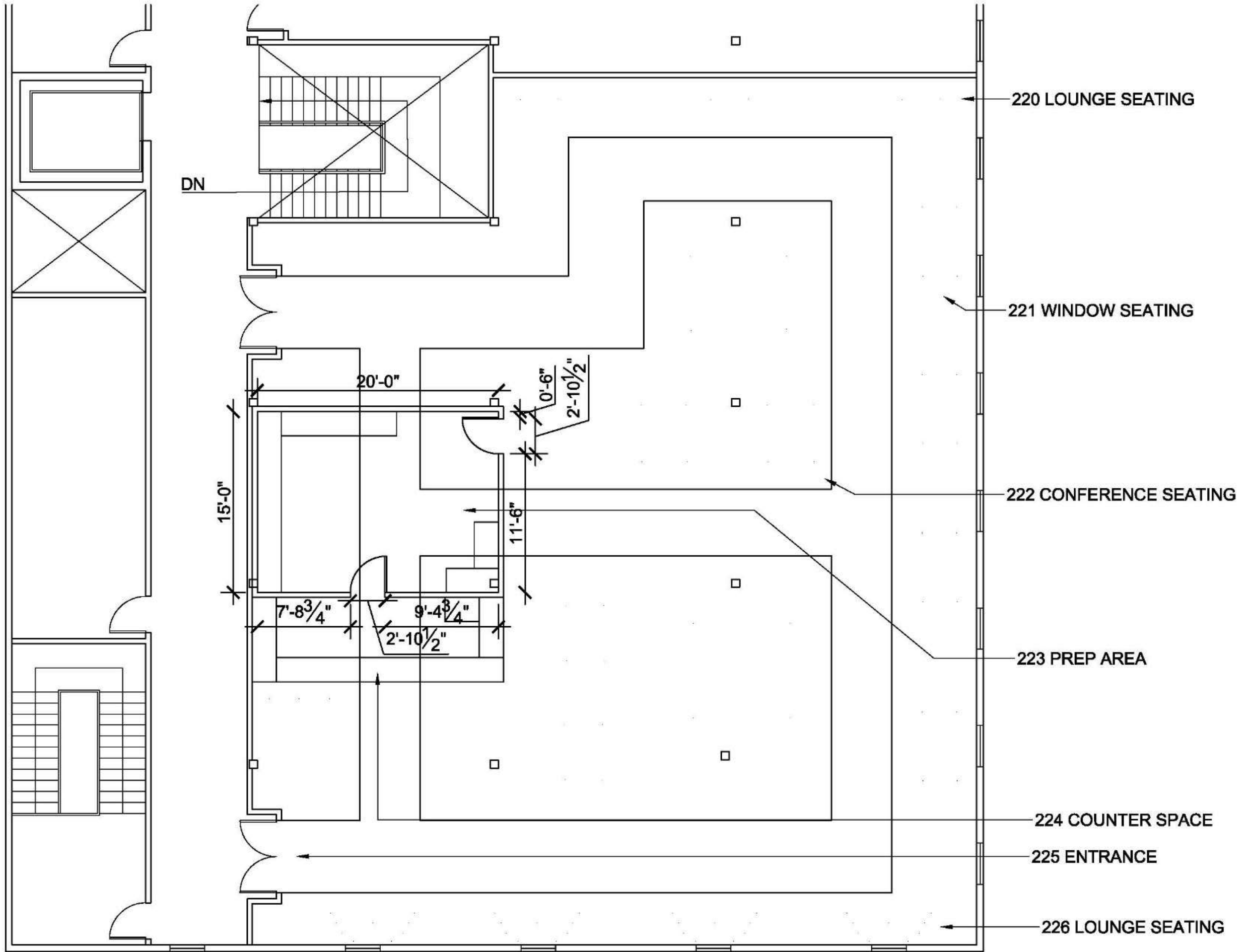

Elizabeth Brown

IDSN 2102 F19

Pathway & Dimension Two

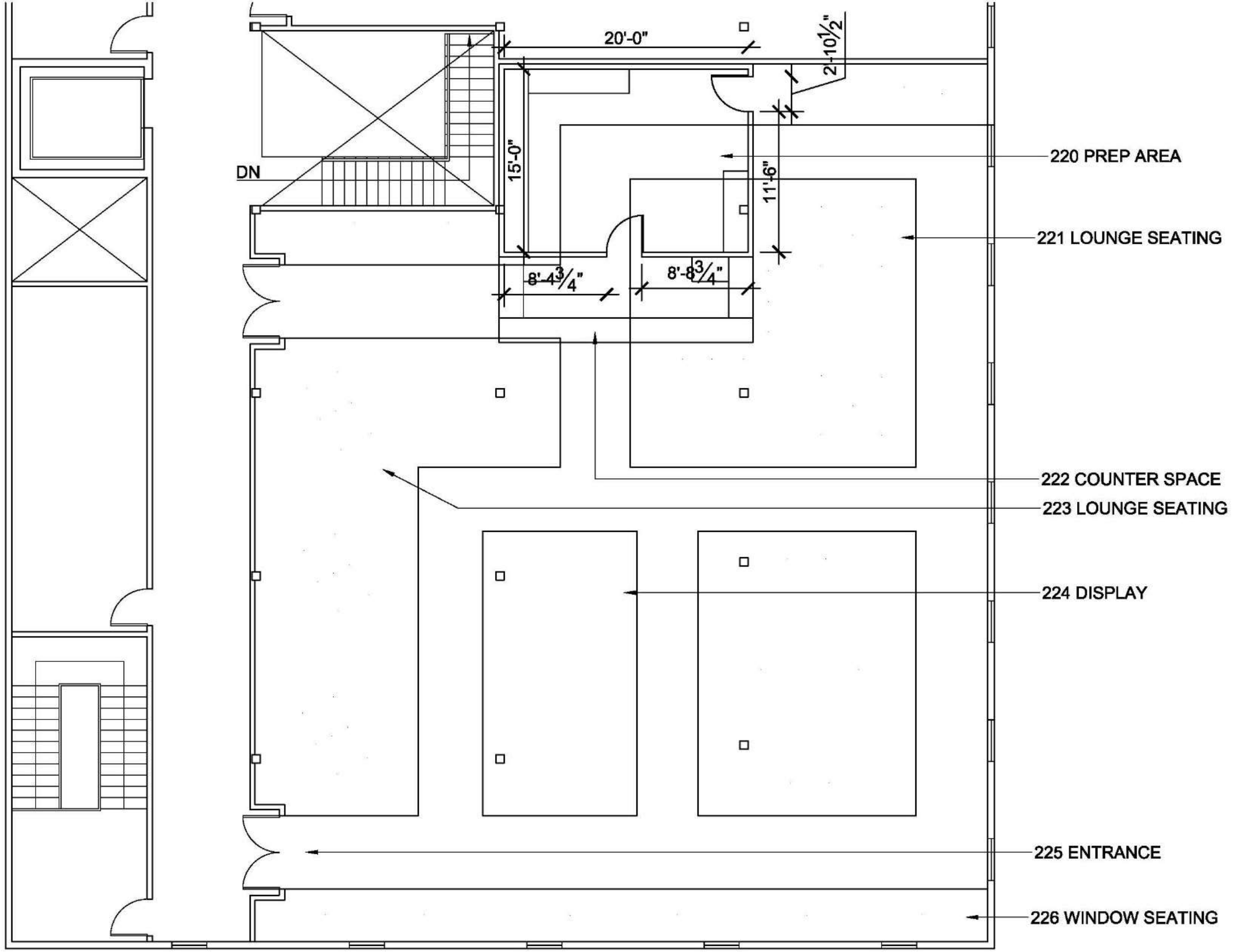

Elizabeth Brown

IDSN 2102 F19

Back of House One

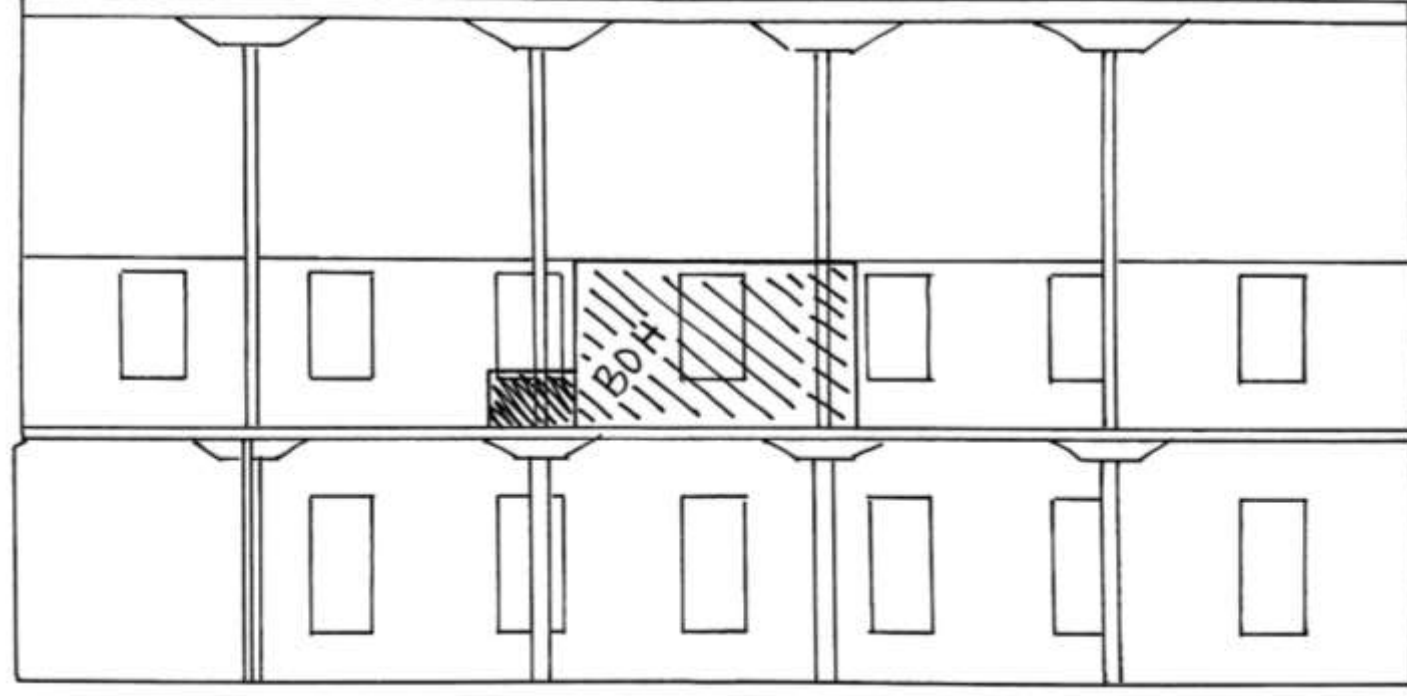
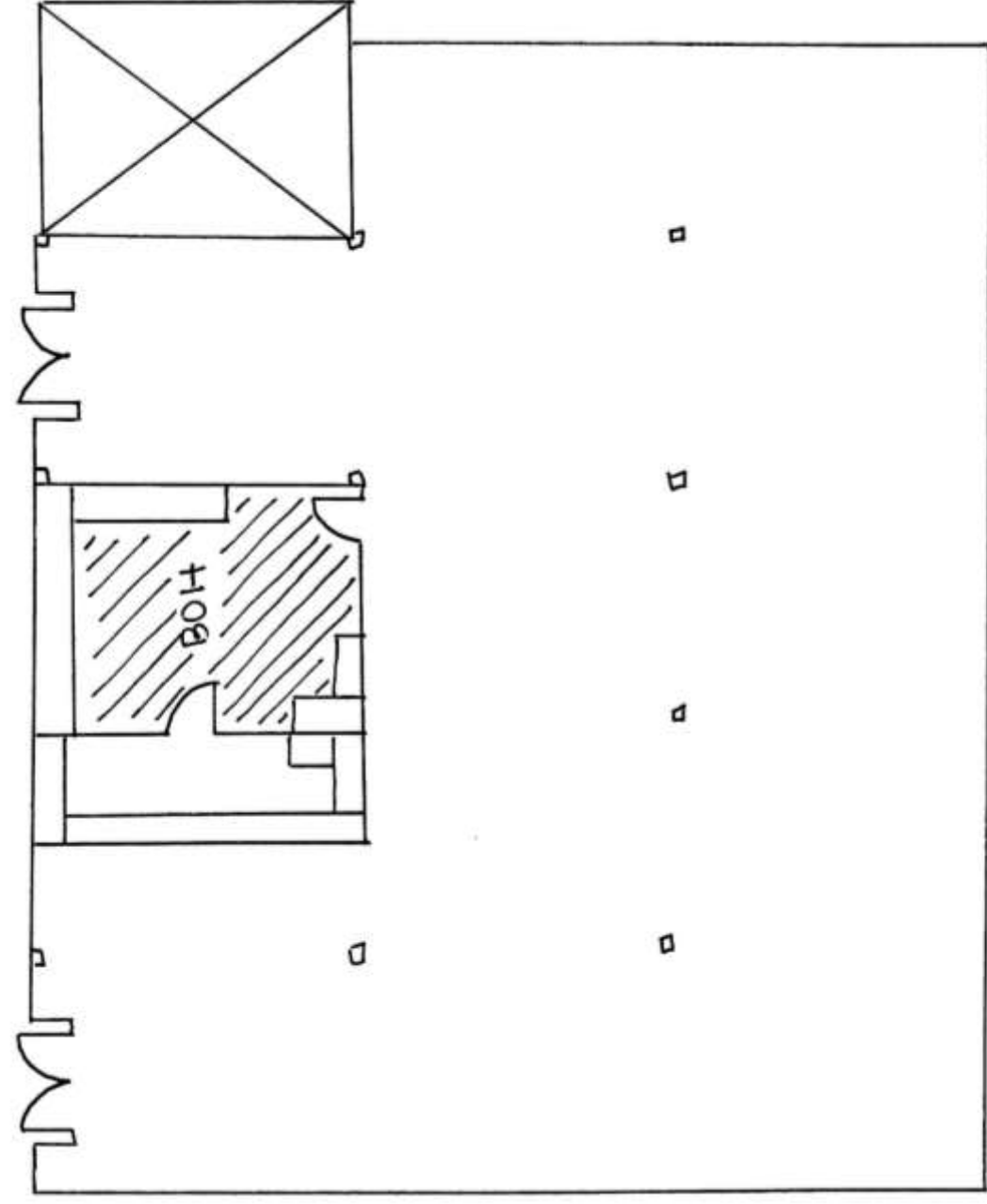

Elizabeth Brown

IDSN 2102 F19

Back of House Two

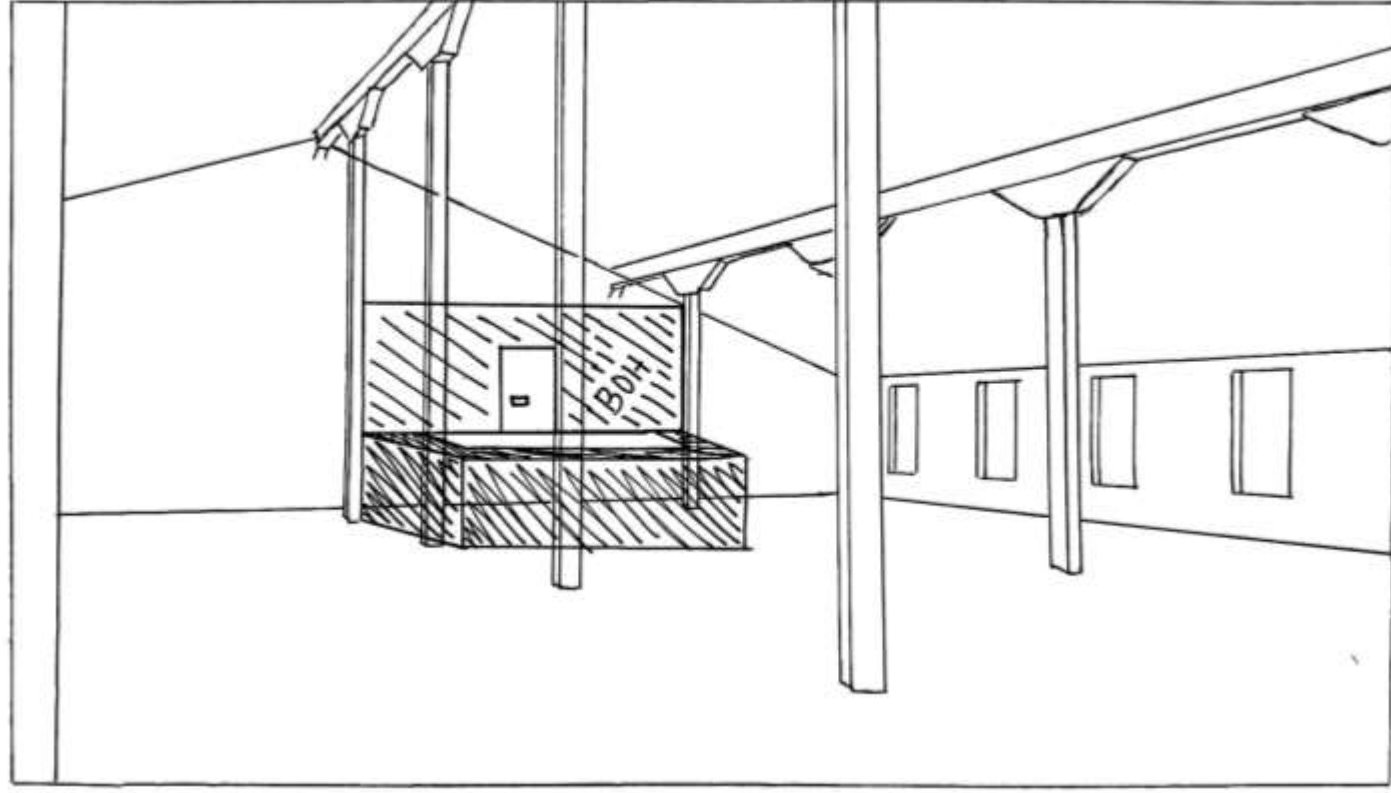
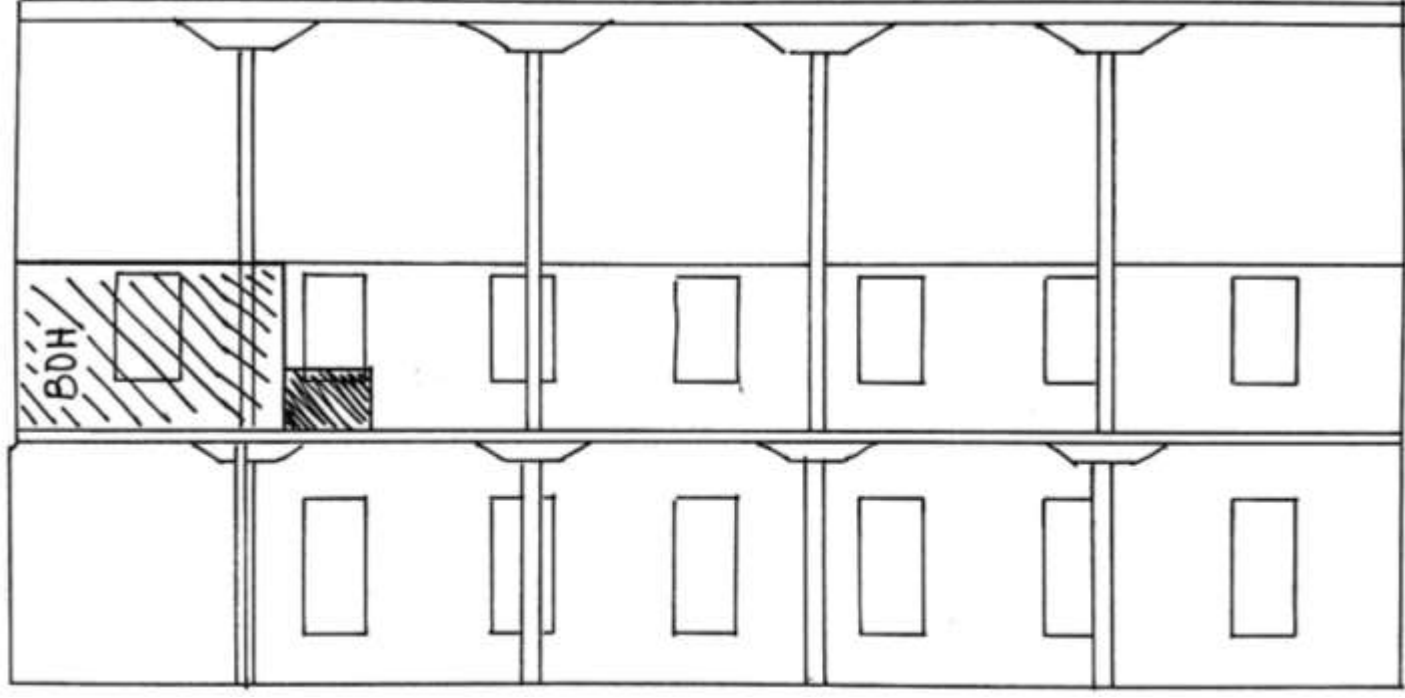
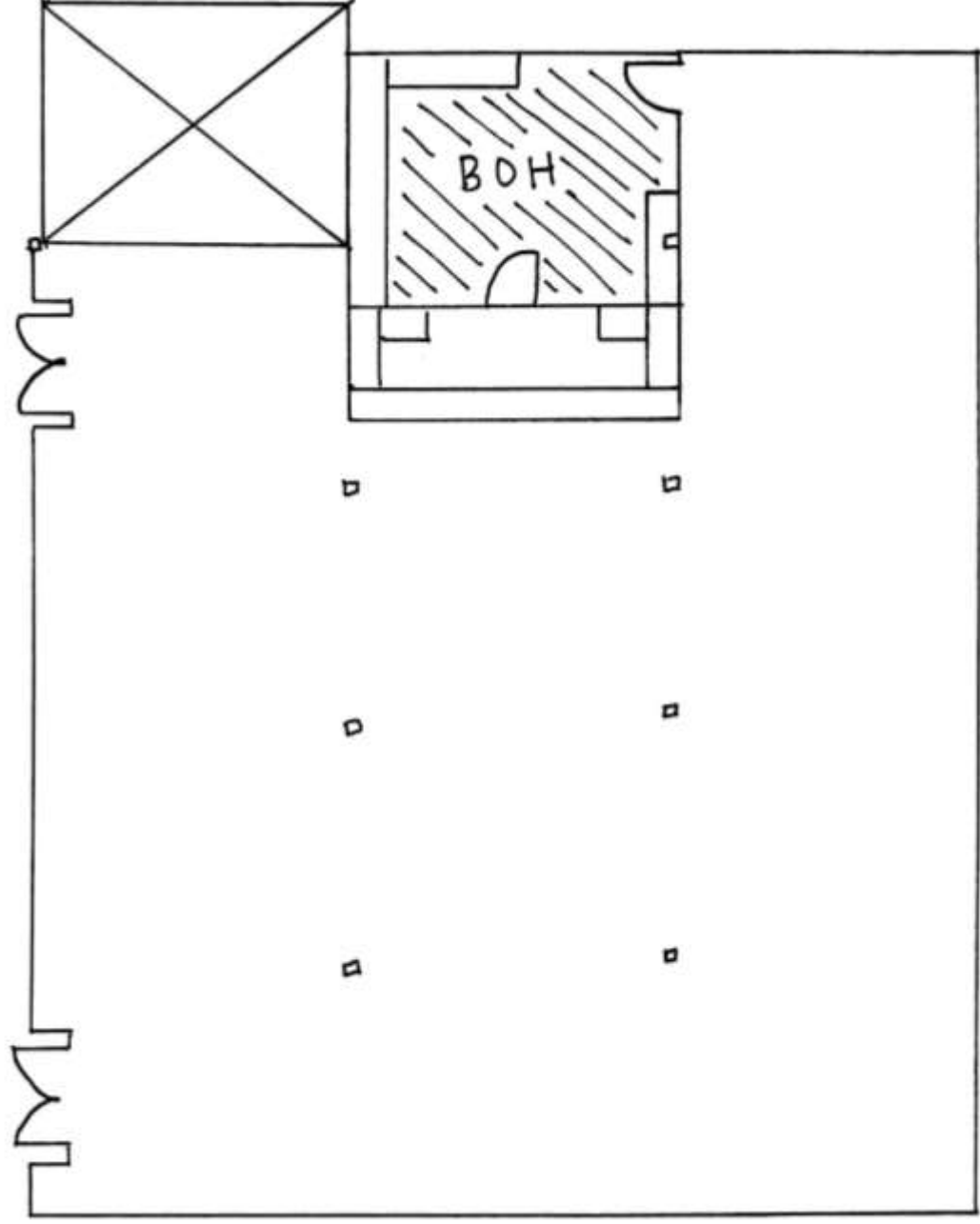

Elizabeth Brown

IDSN 2102 F19

Ceiling & Daylighting One

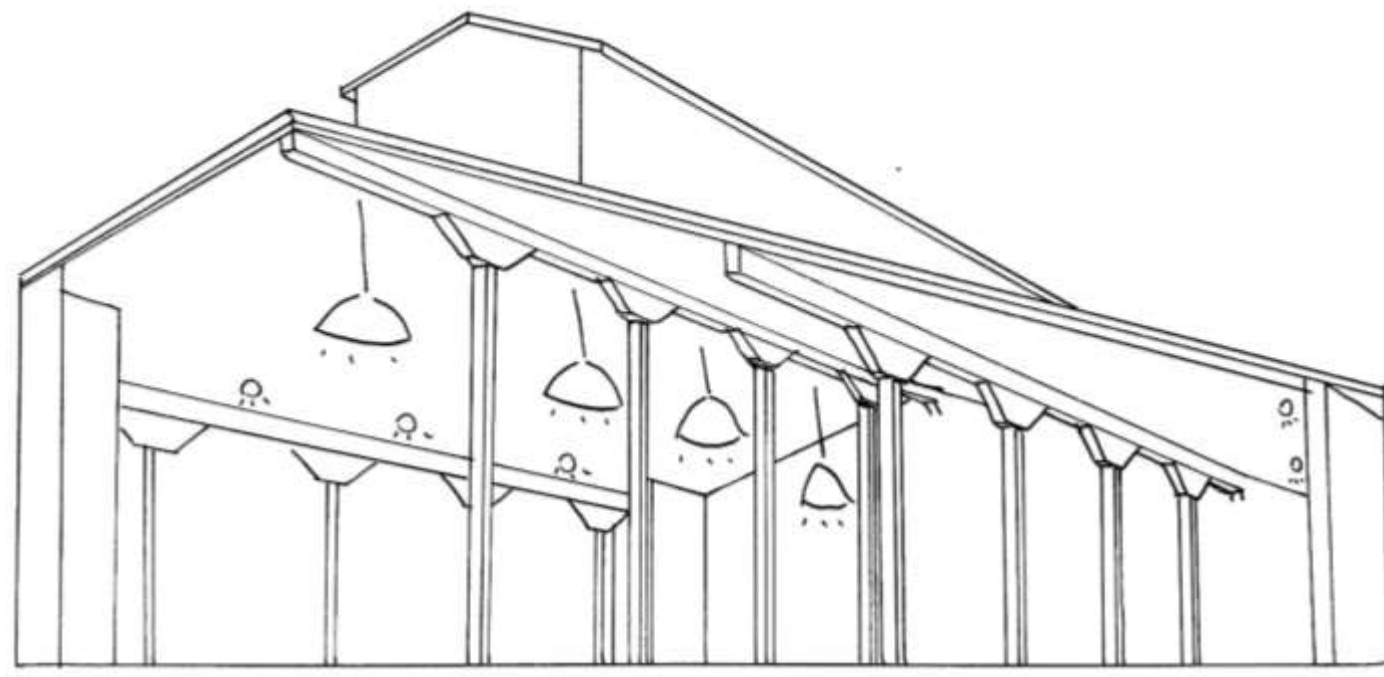
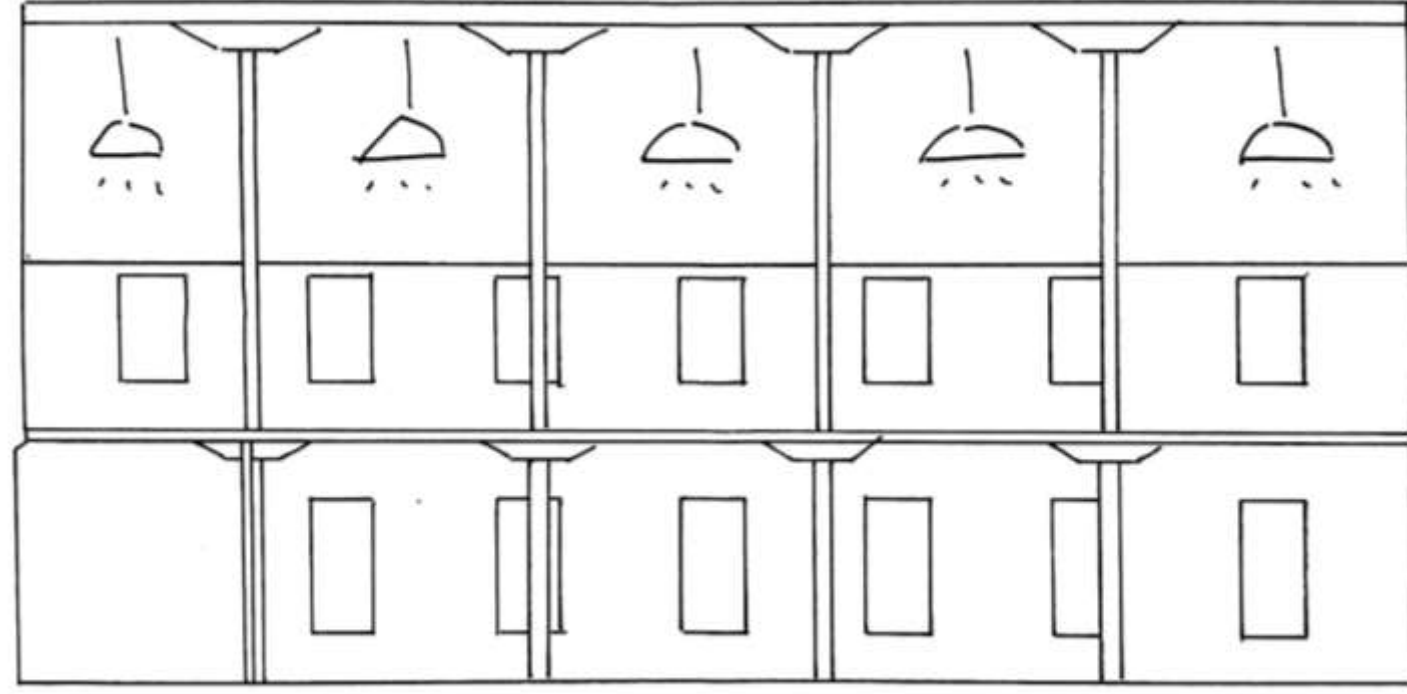
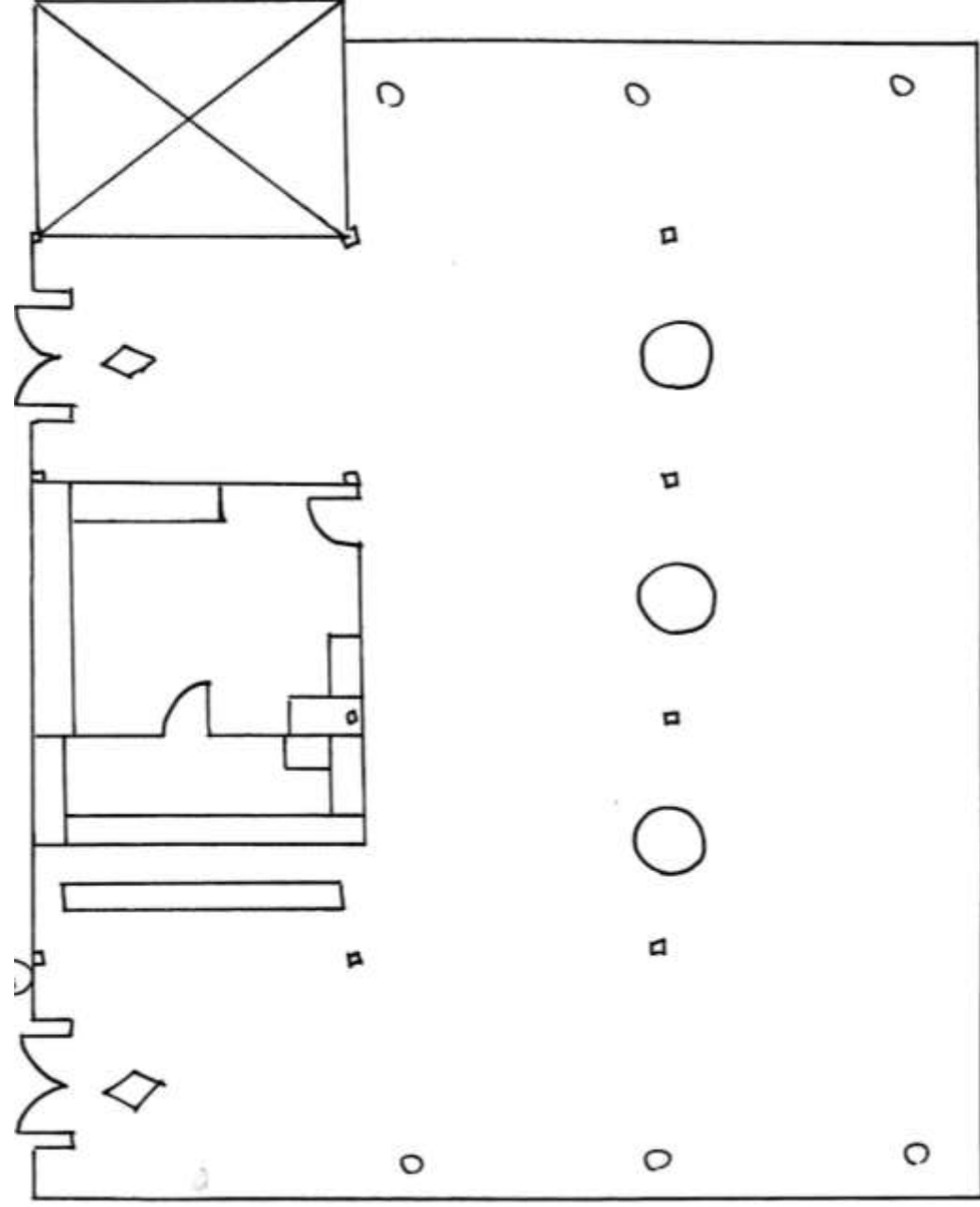

Elizabeth Brown

IDSN 2102 F19

Ceiling & Daylighting Two

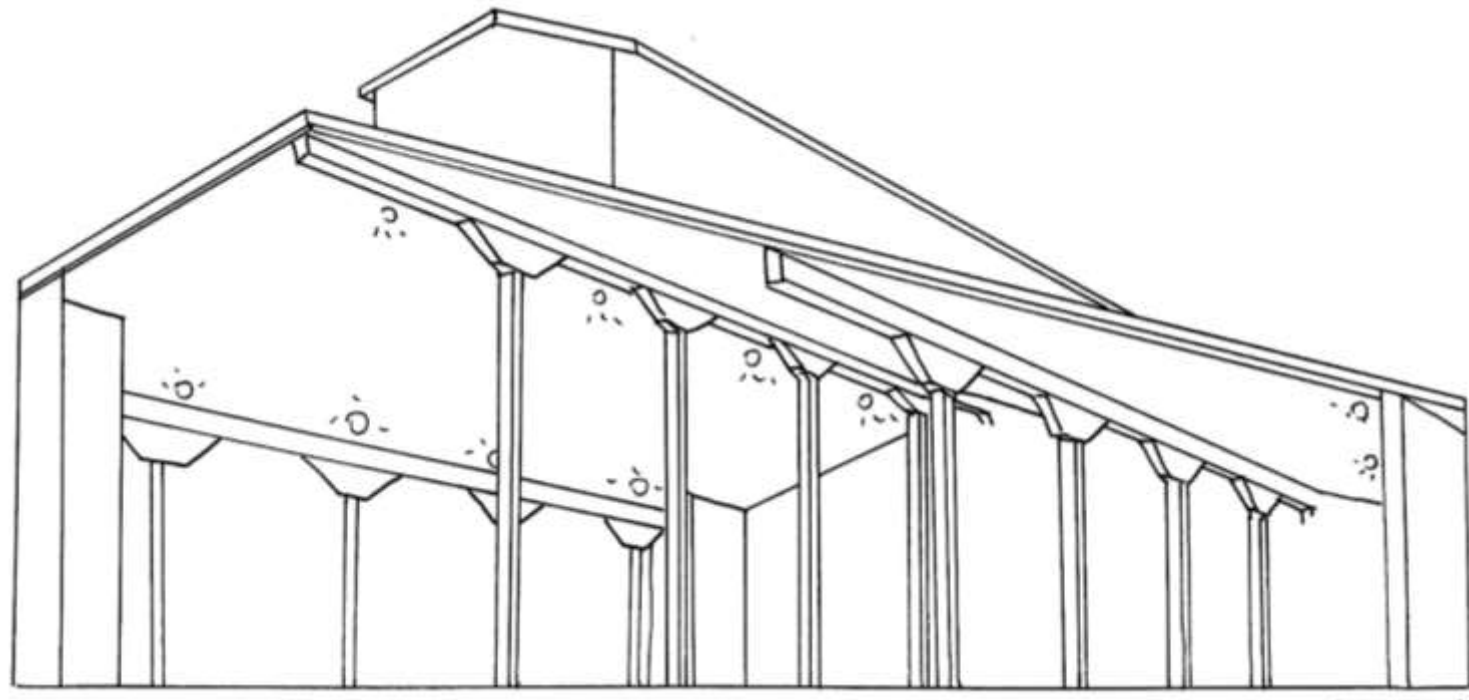
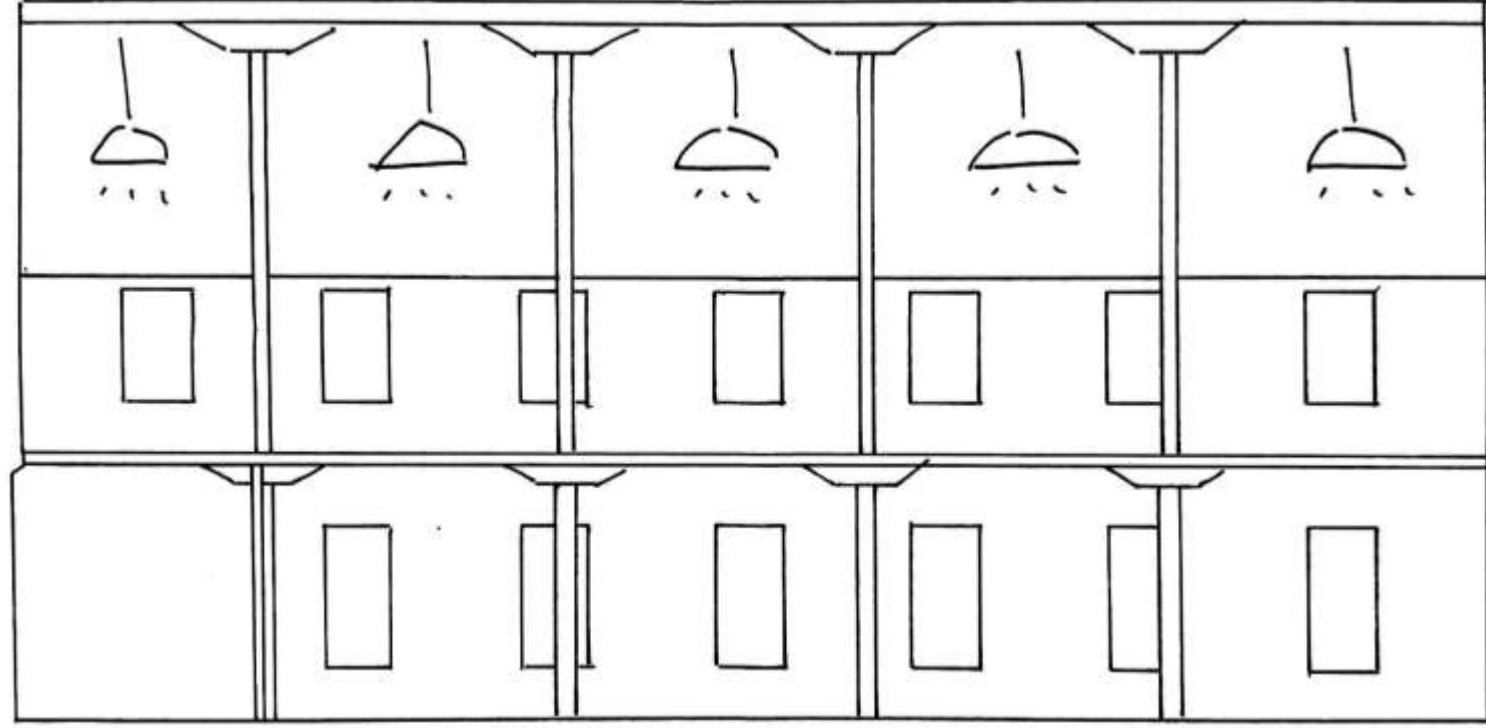
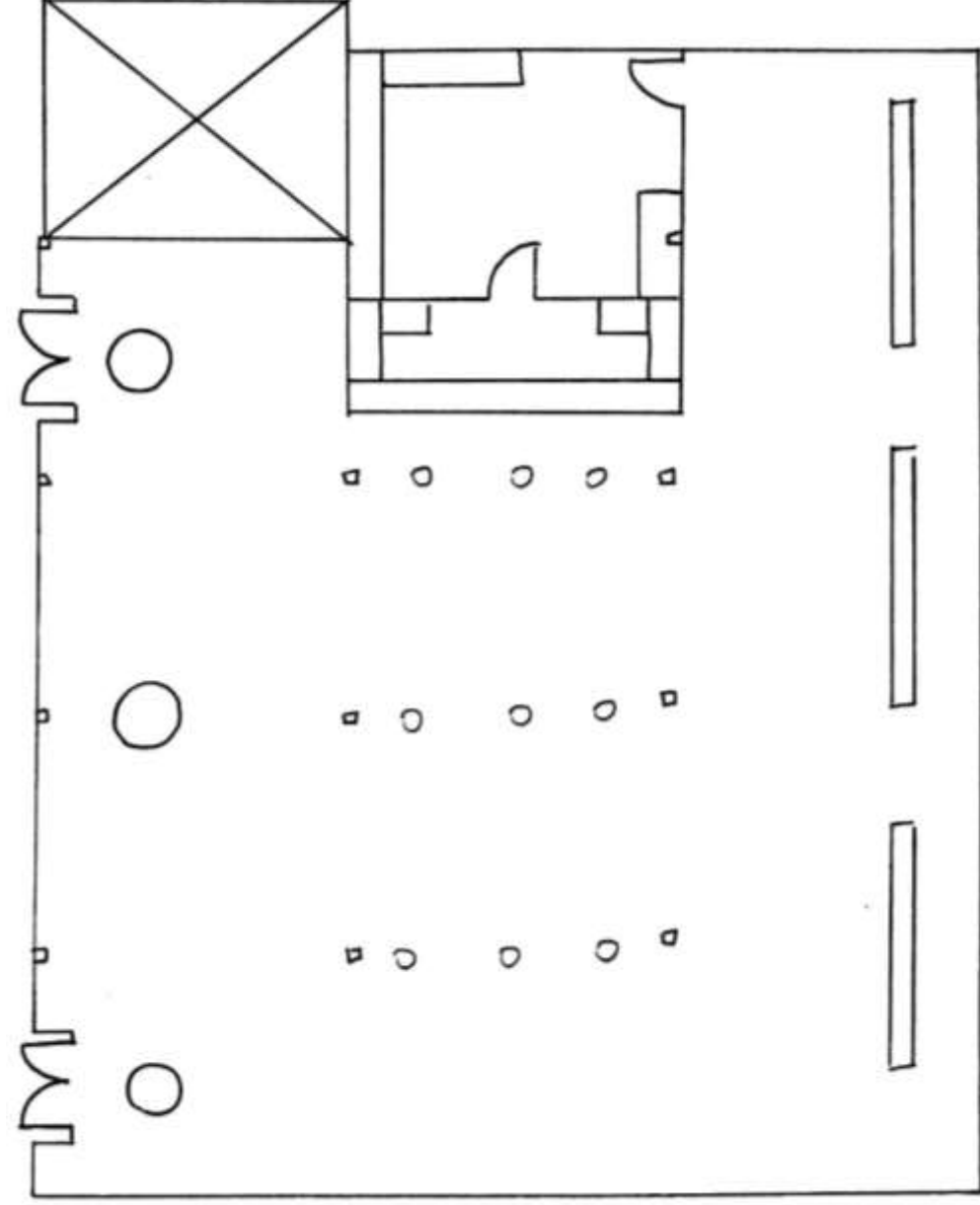

Elizabeth Brown

IDSN 2102 F19

Stairs One

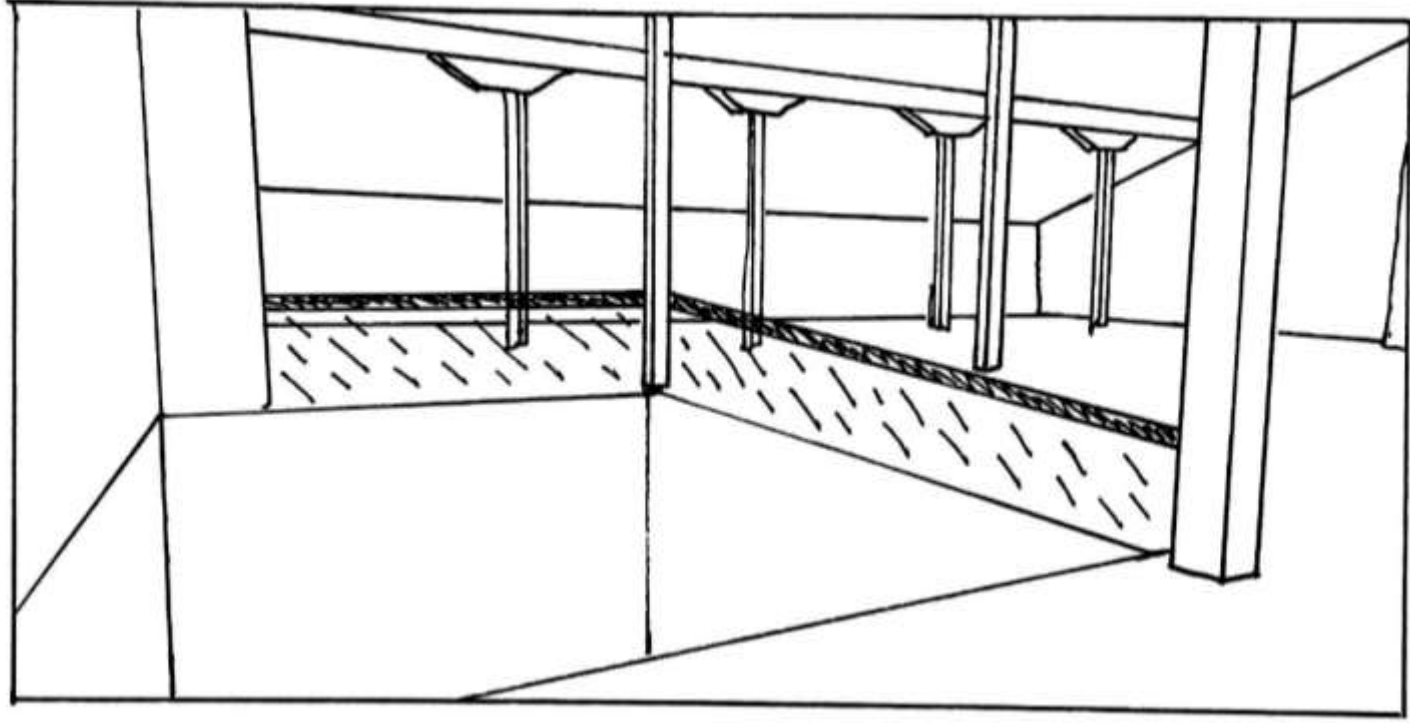
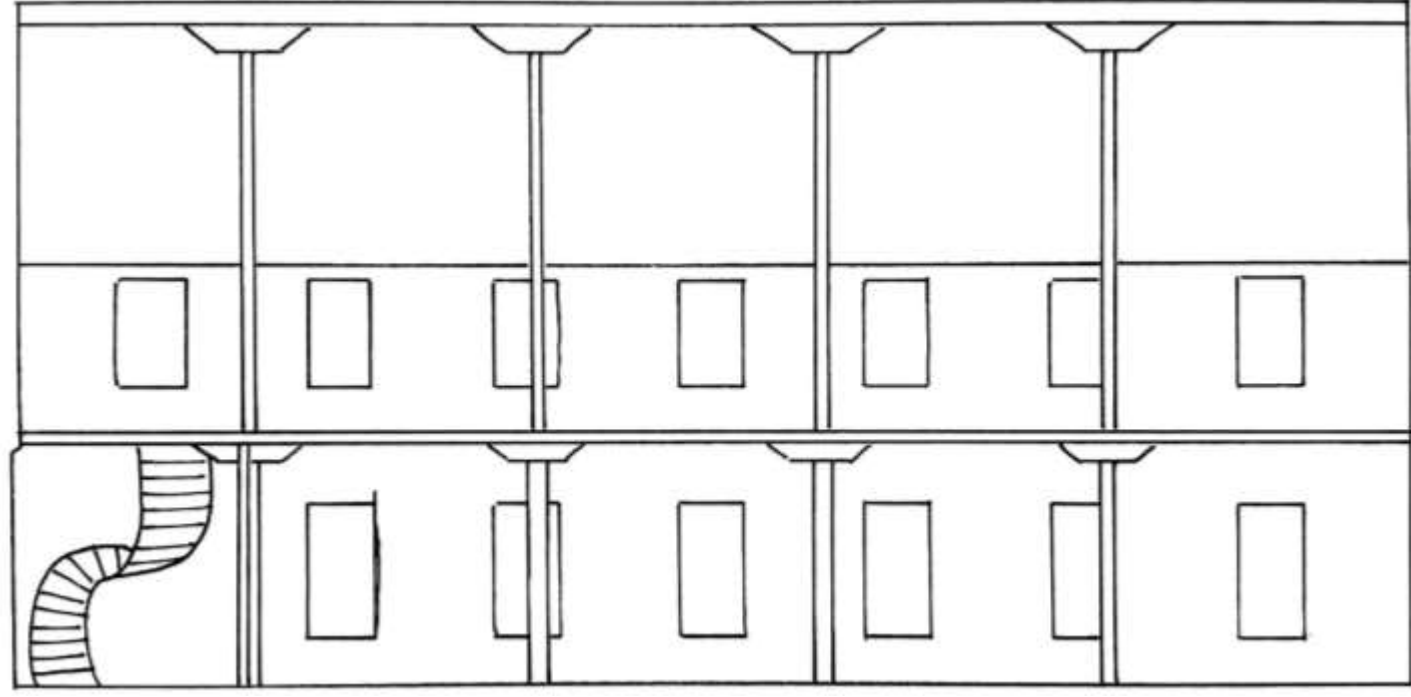
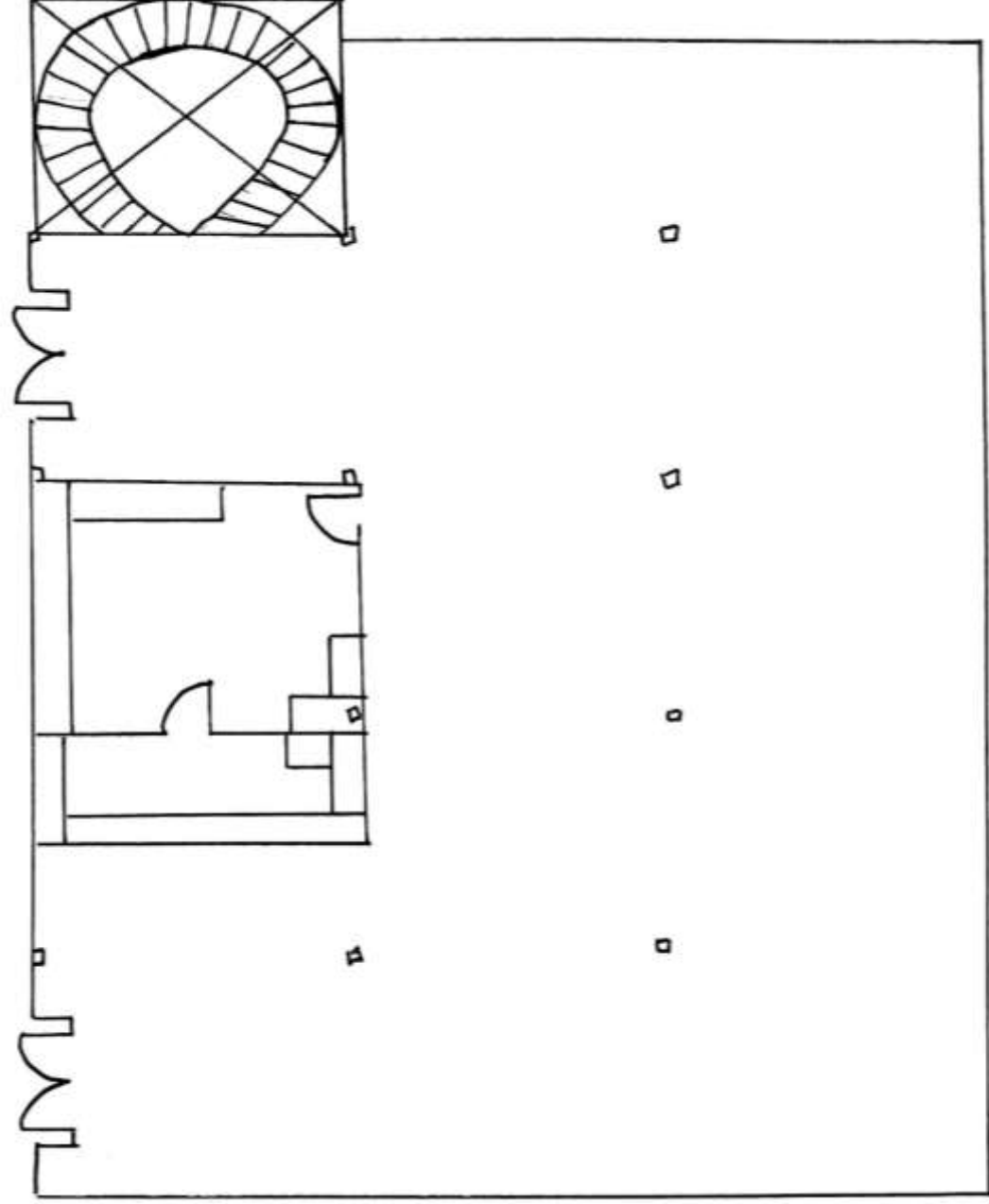

Elizabeth Brown

IDSN 2102 F19

Stairs Two

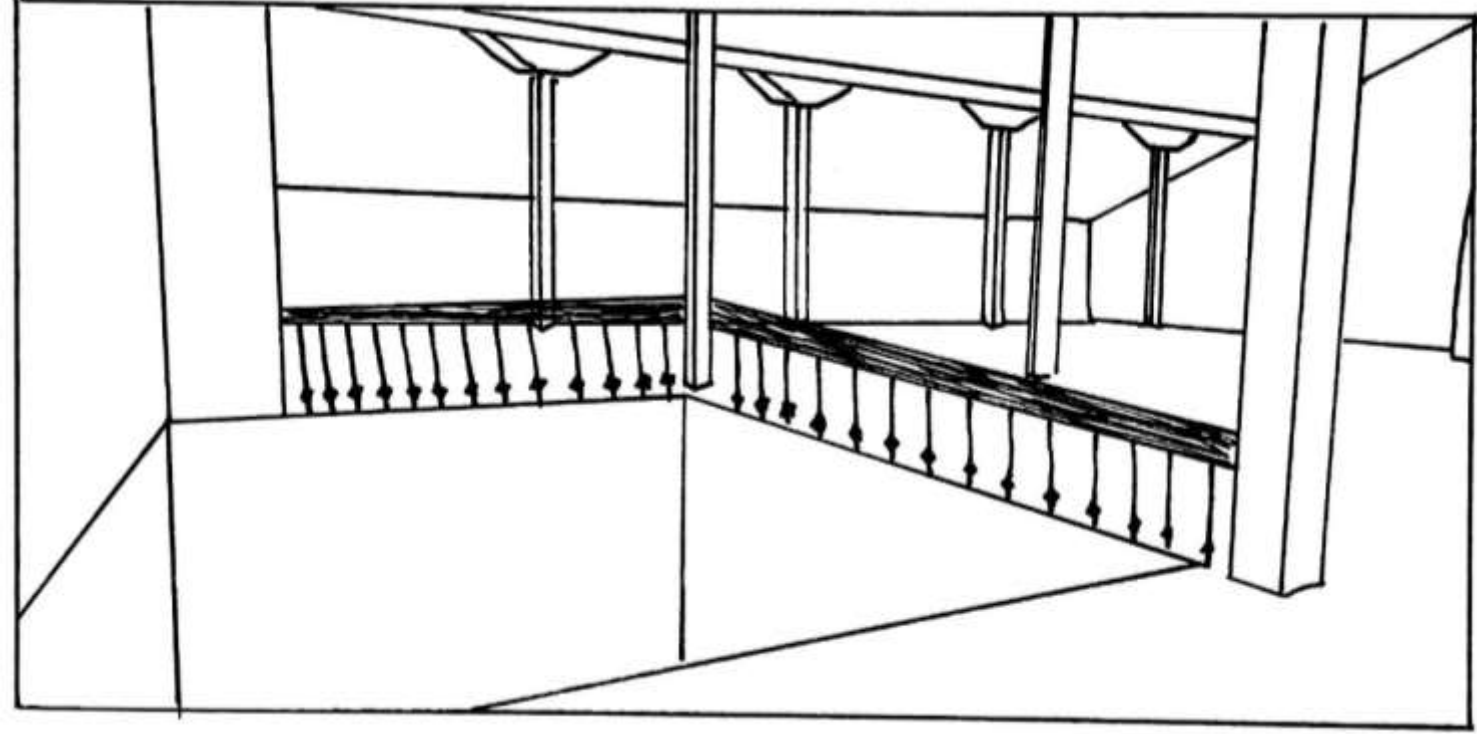
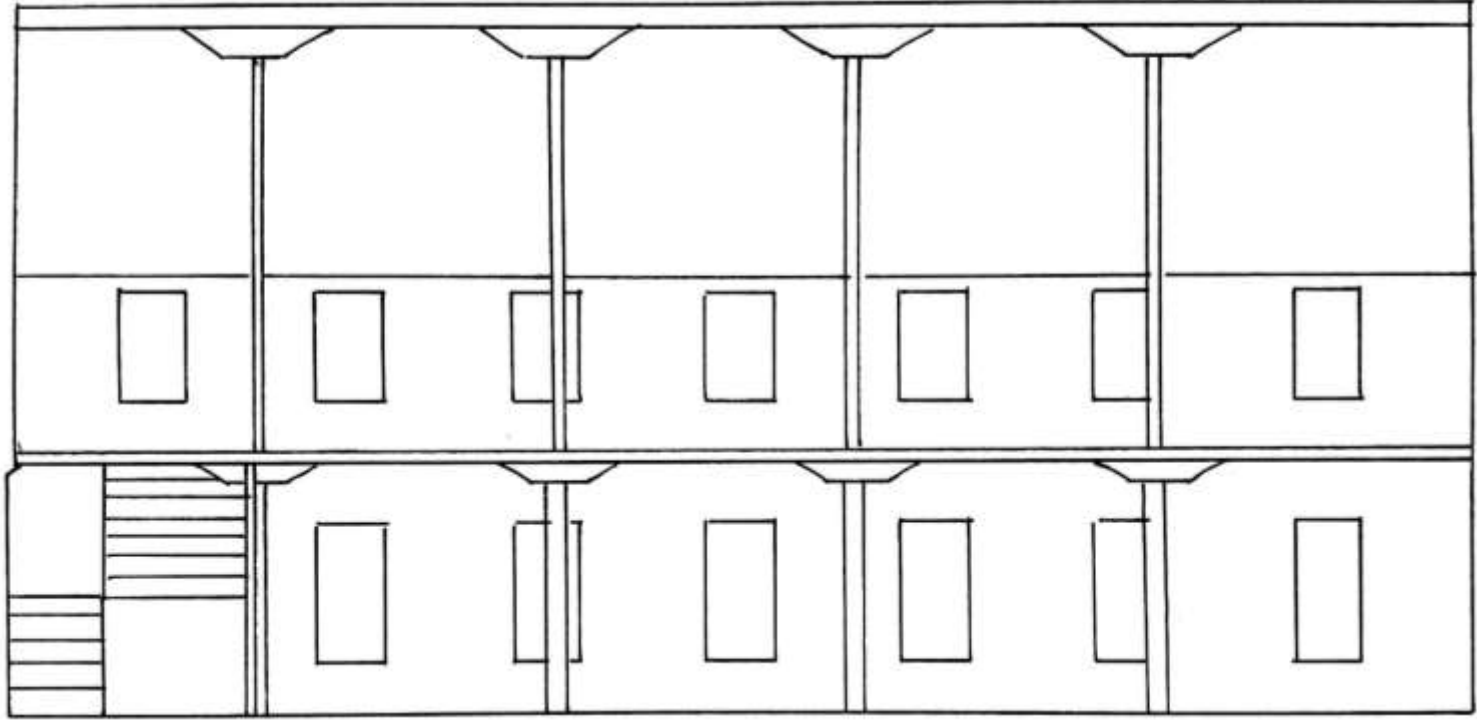
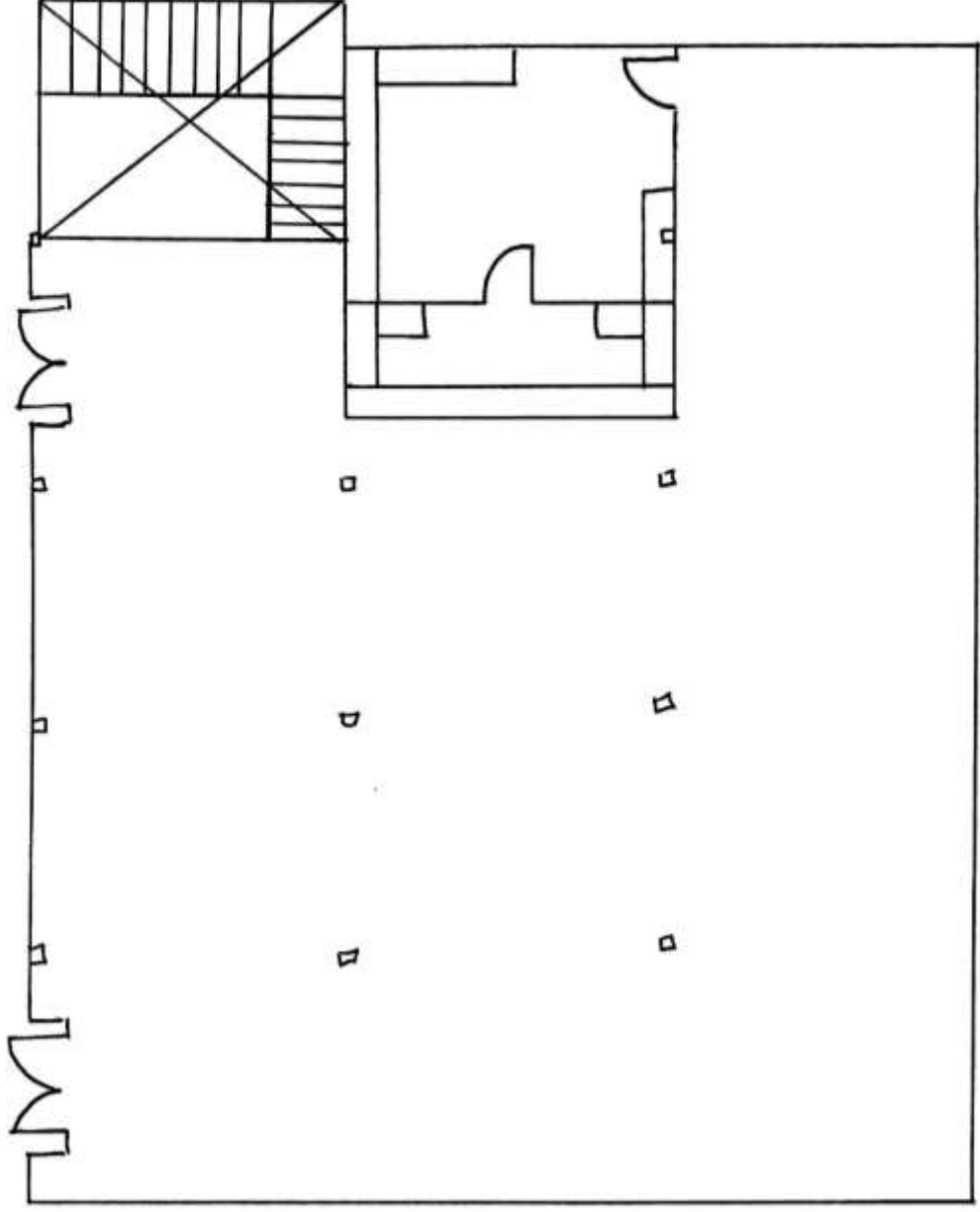

Elizabeth Brown

IDSN 2102 F19

Wayfinding One

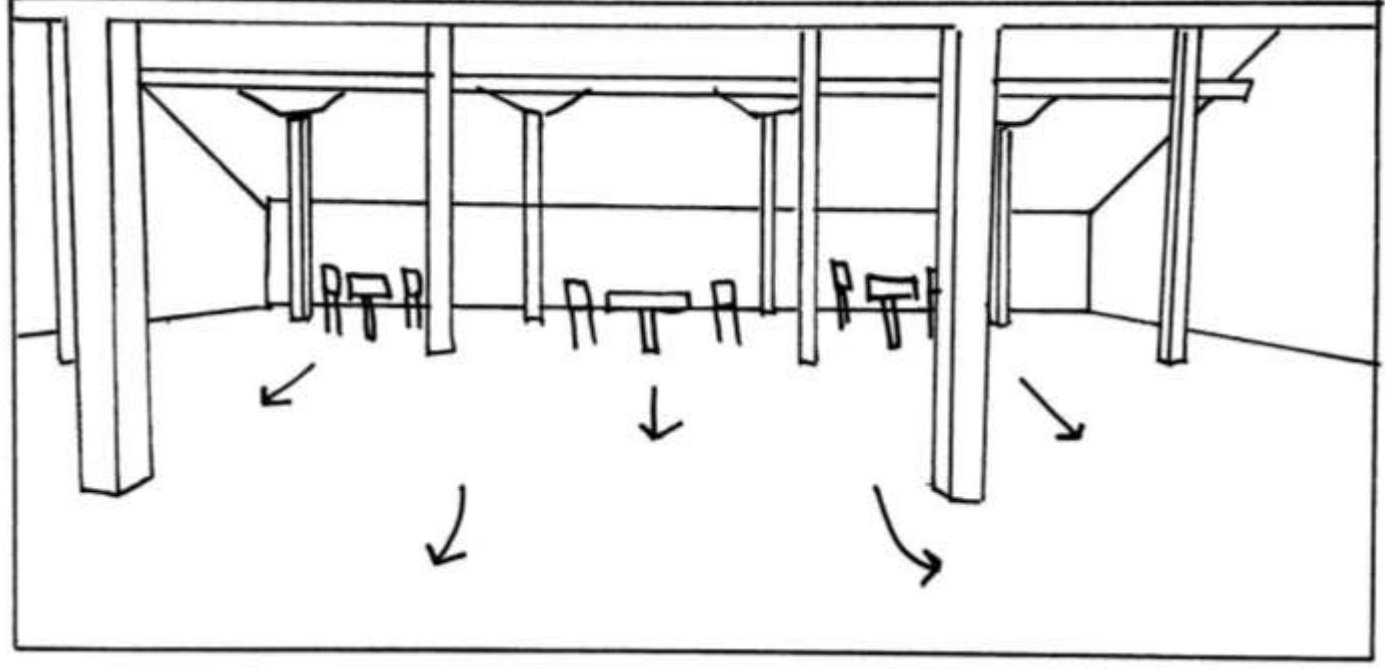
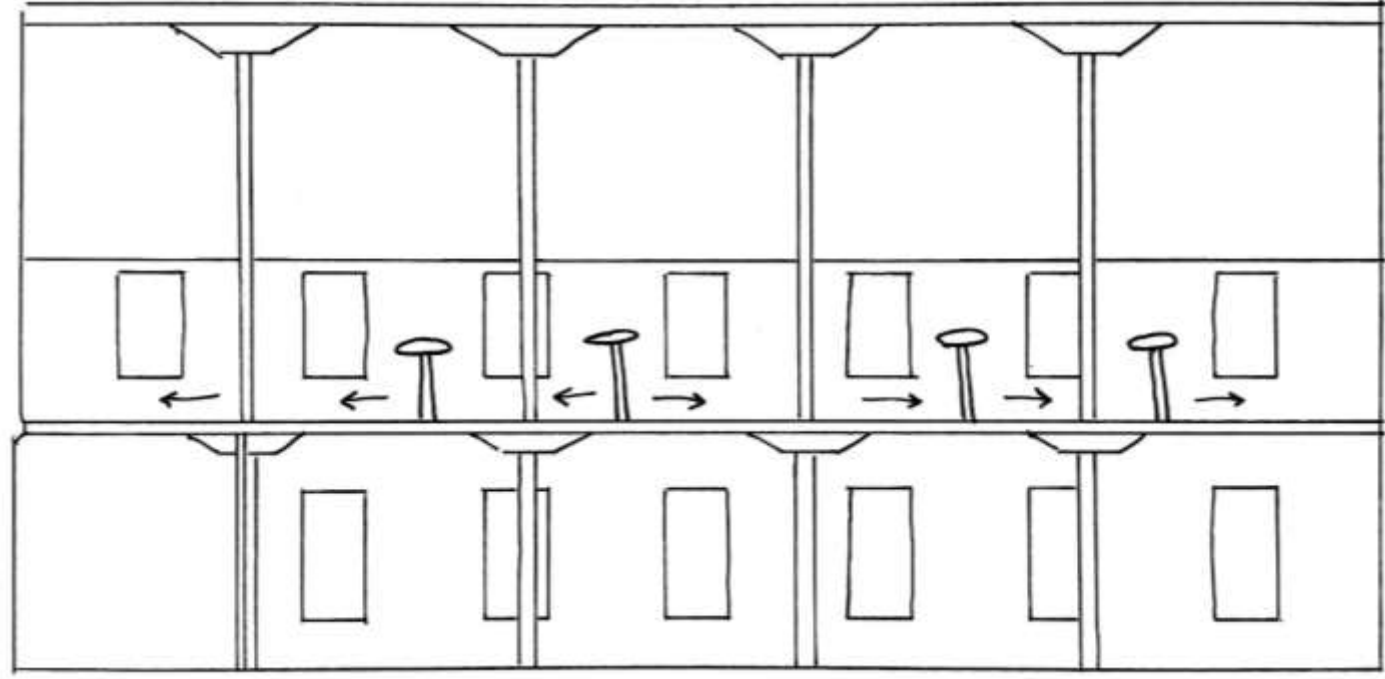
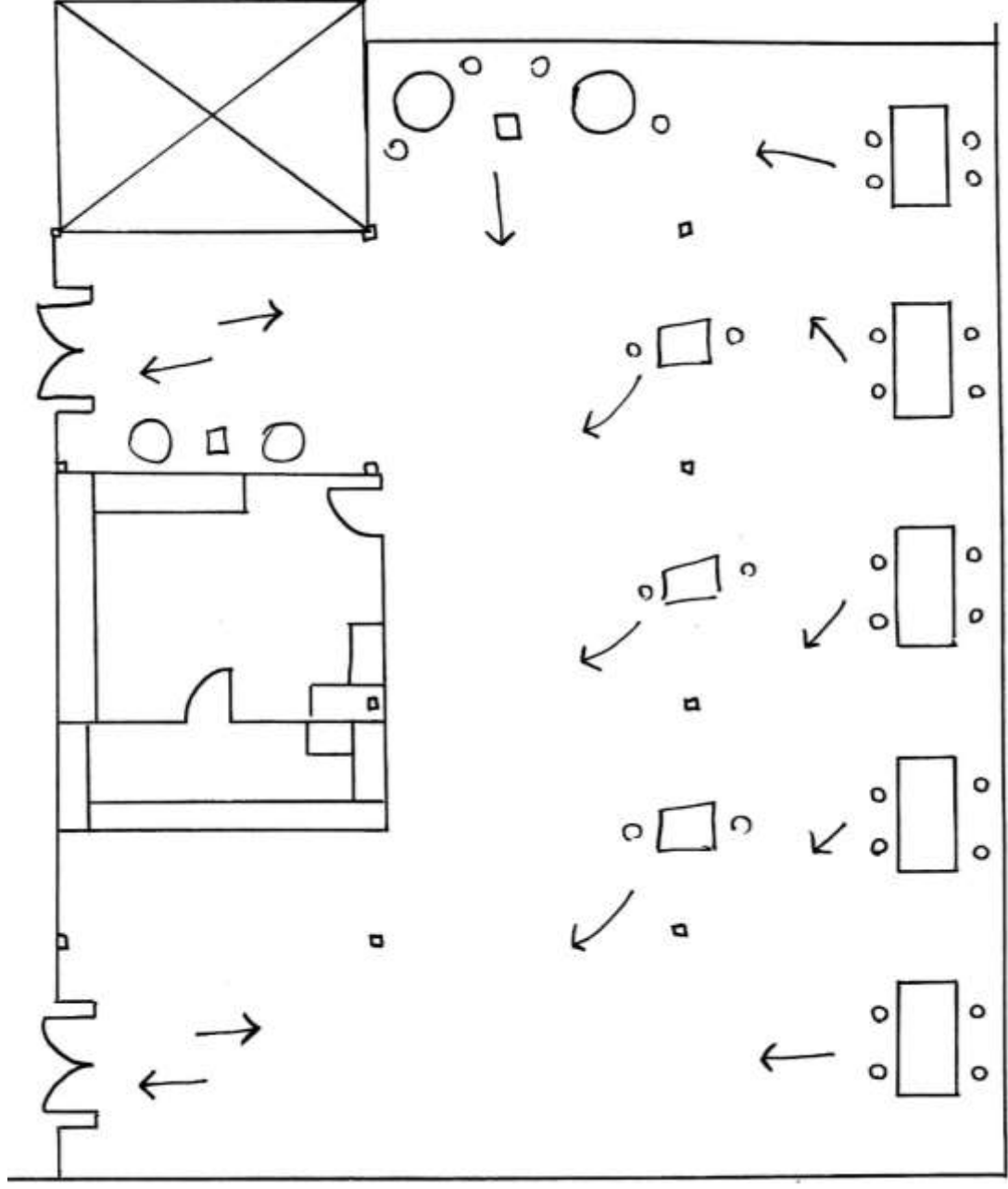

Elizabeth Brown

IDSN 2102 F19

Wayfinding Two

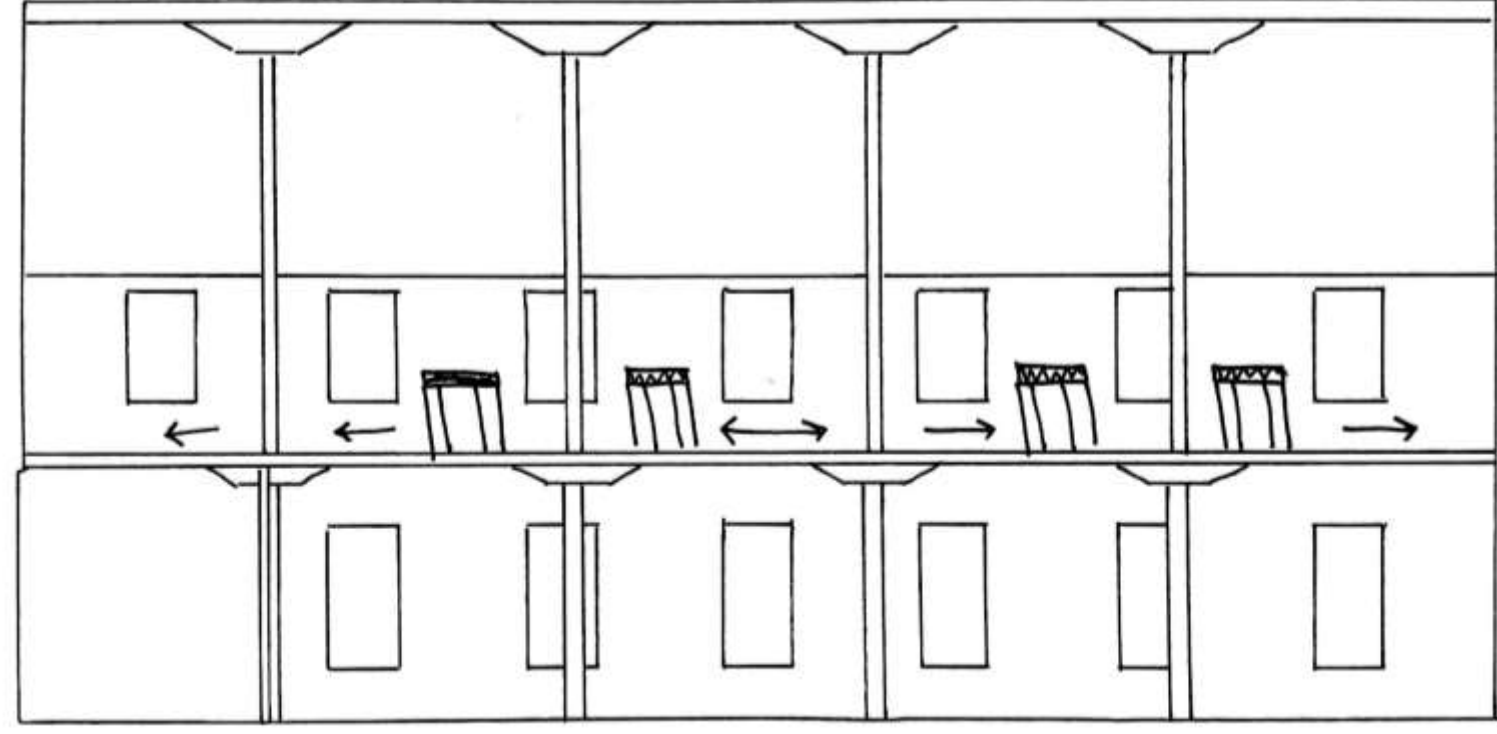
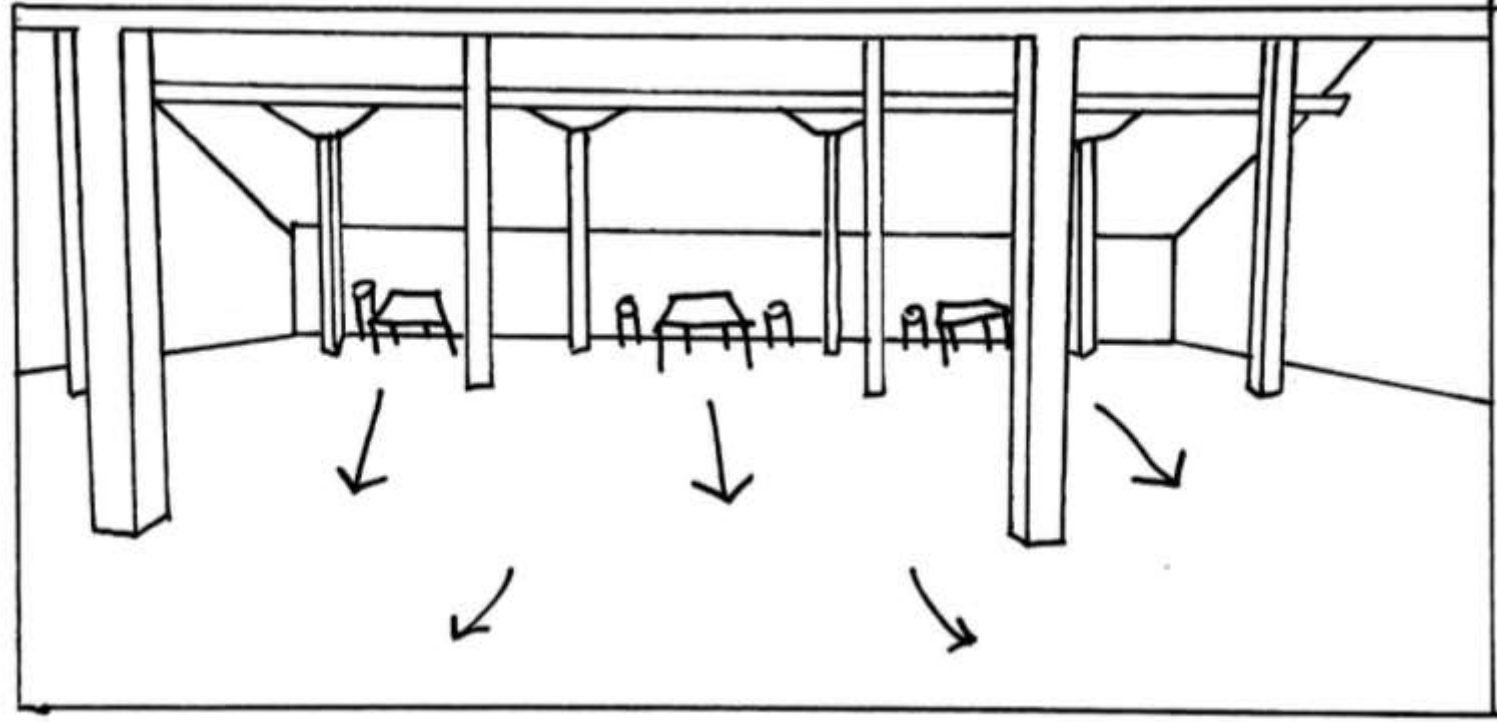
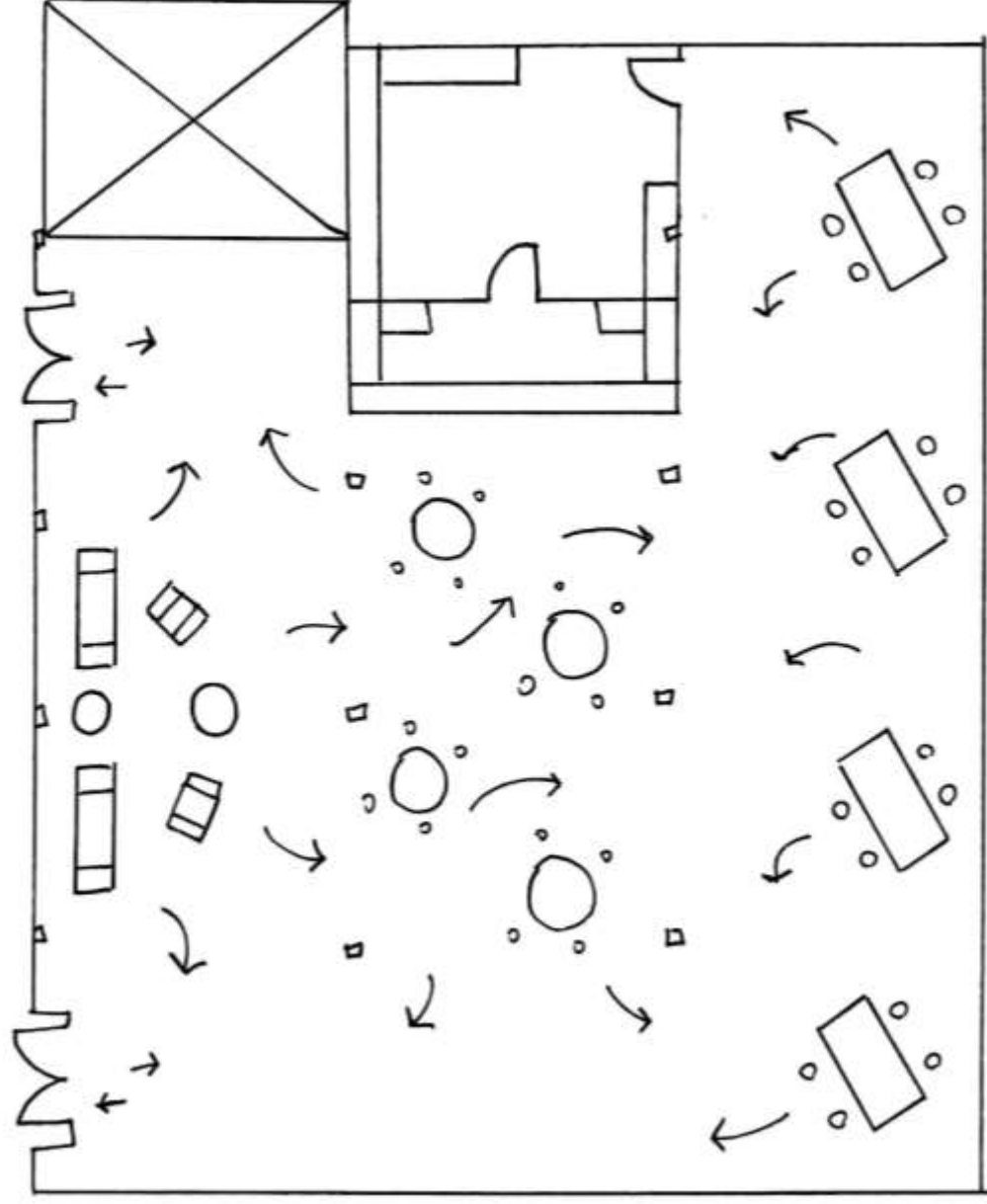

Elizabeth Brown

IDSN 2102 F19

Floor Plan One

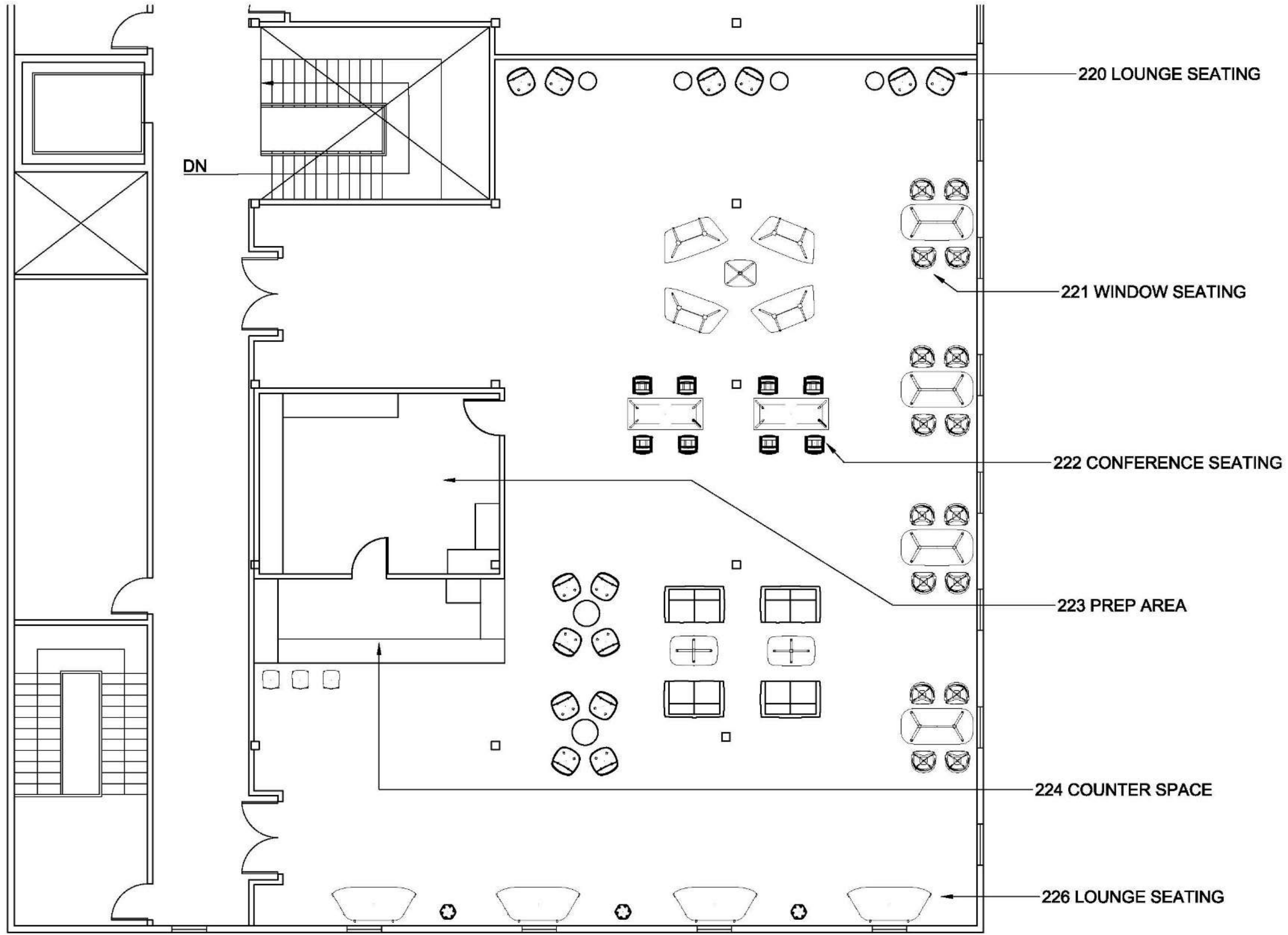

Elizabeth Brown

IDSN 2102 F19

Floor Plan Two

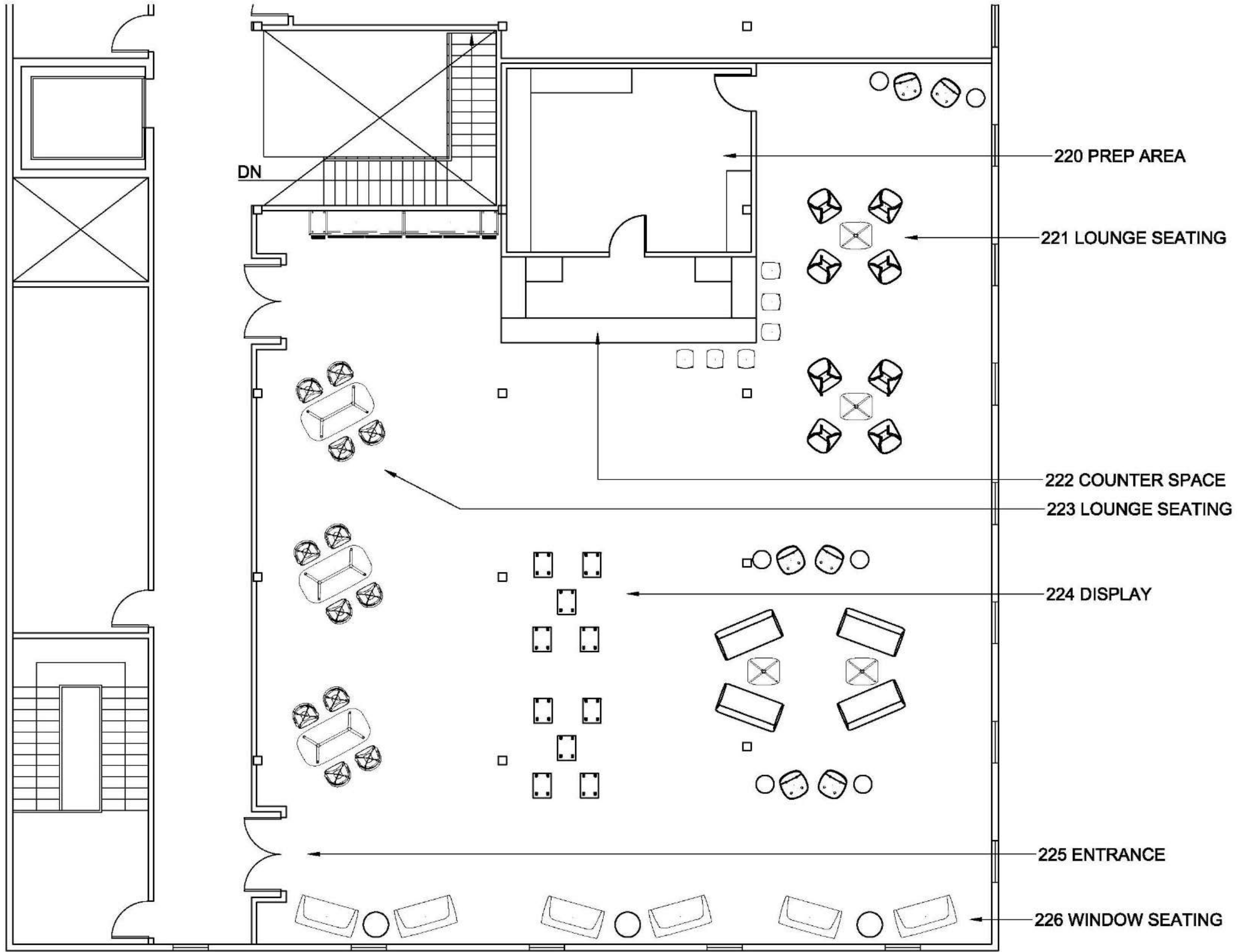

Elizabeth Brown

IDSN 2102 F19

Floor Plan Three

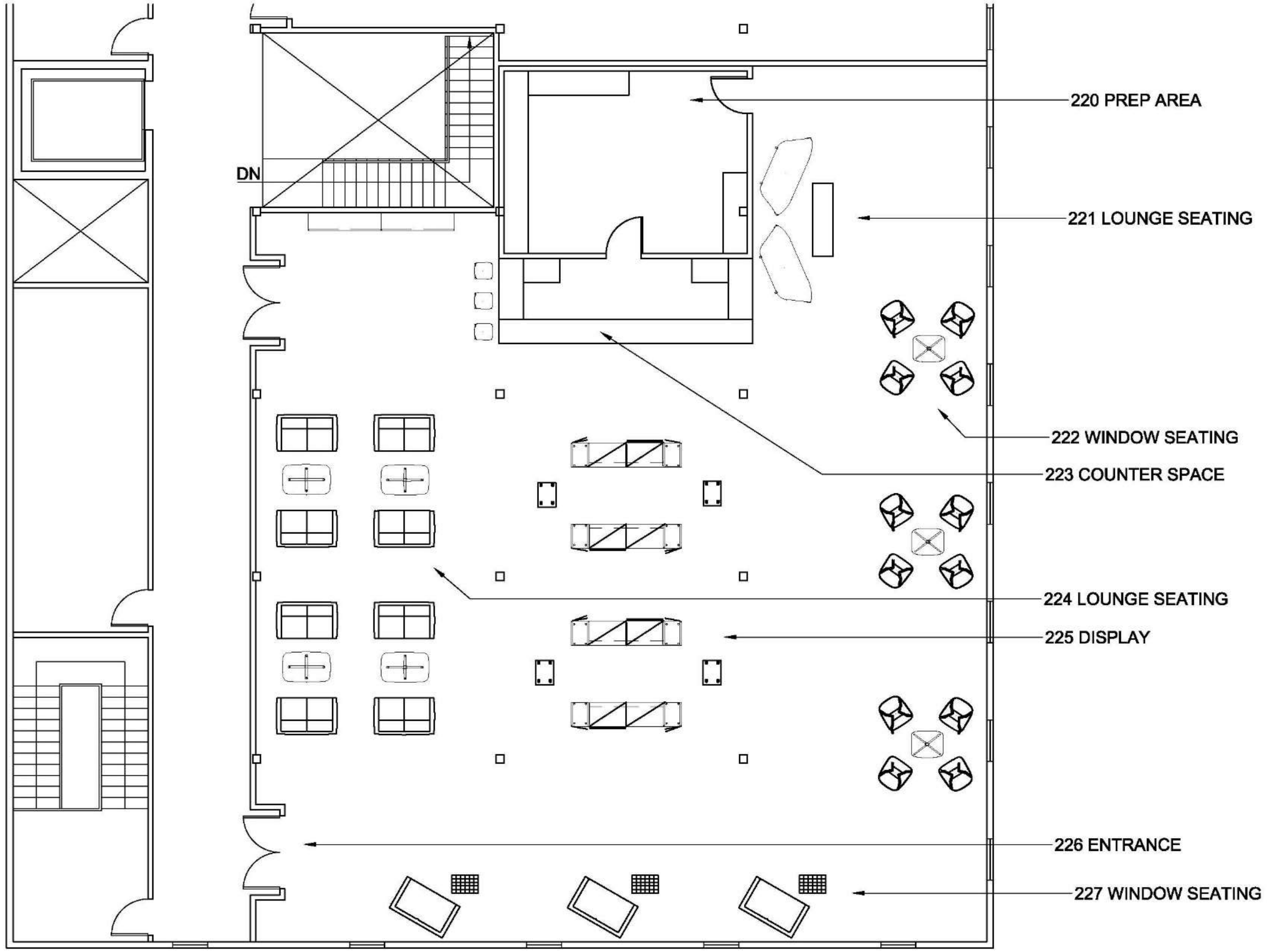

Elizabeth Brown

IDSN 2102 F19

Scissor Stairs - Plan & Section

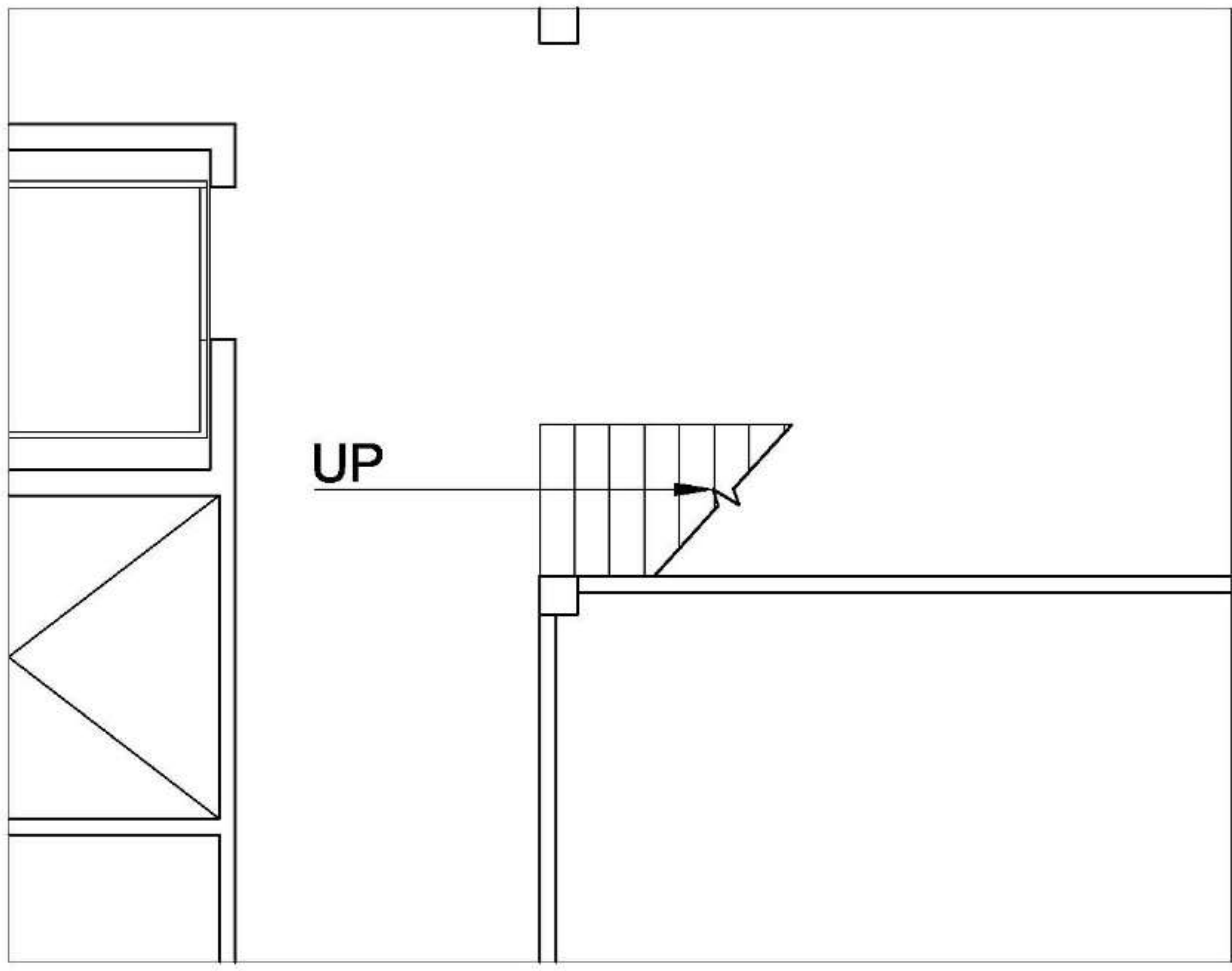
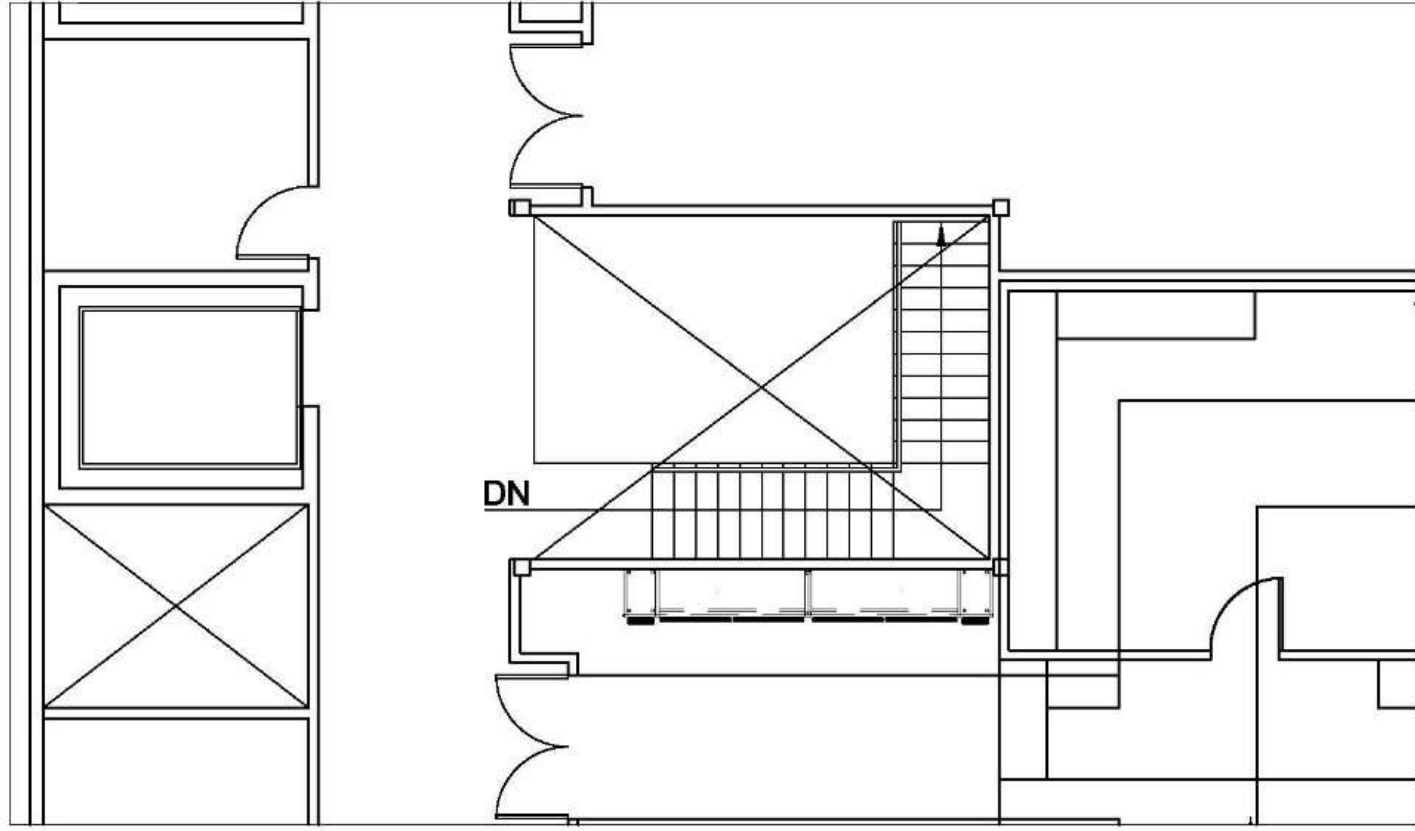
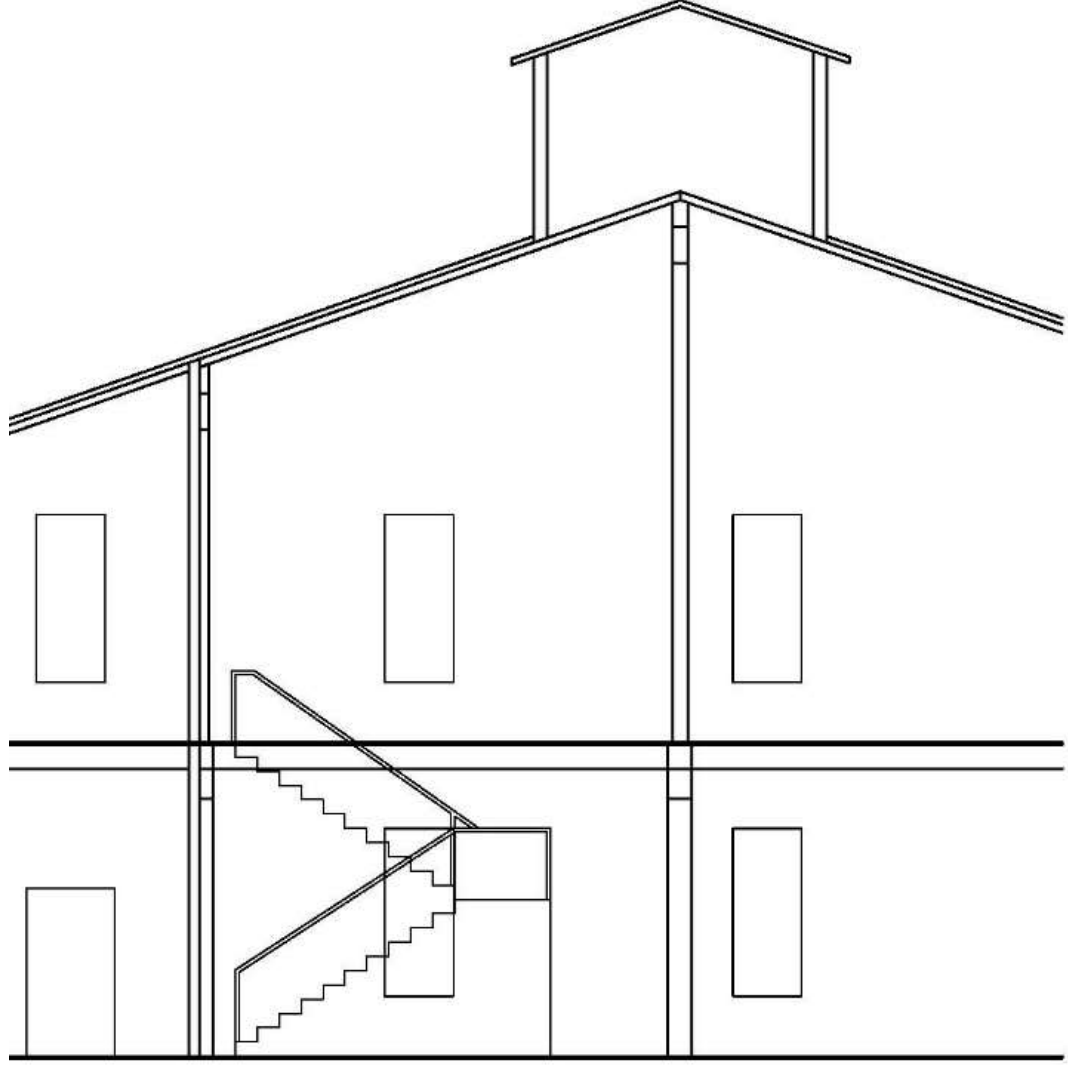

Elizabeth Brown

IDSN 2102 F19

L-Shape Stairs - Plan & Section

