

second floor

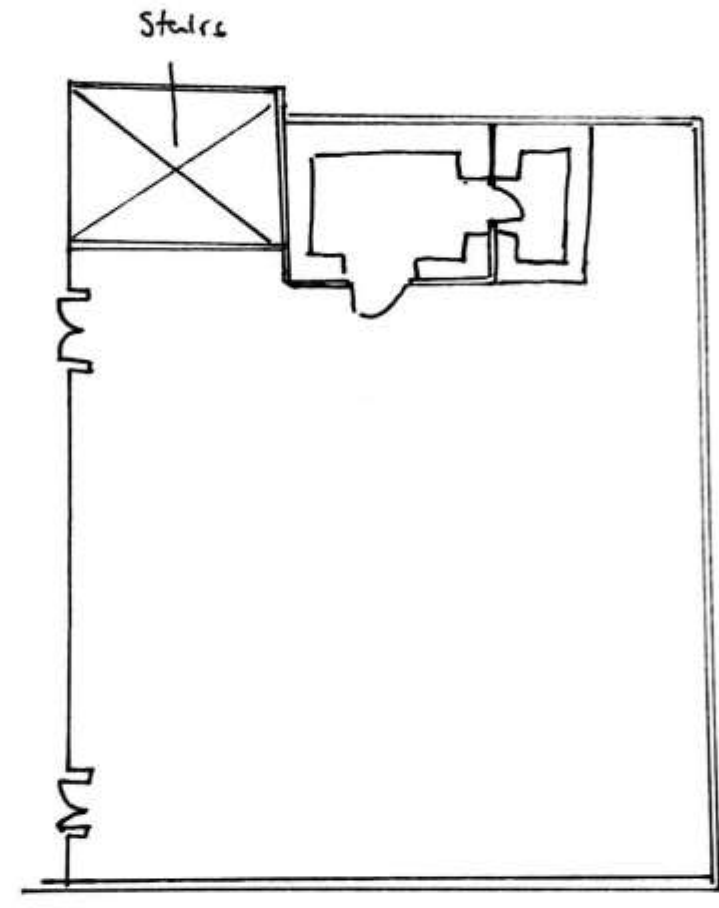

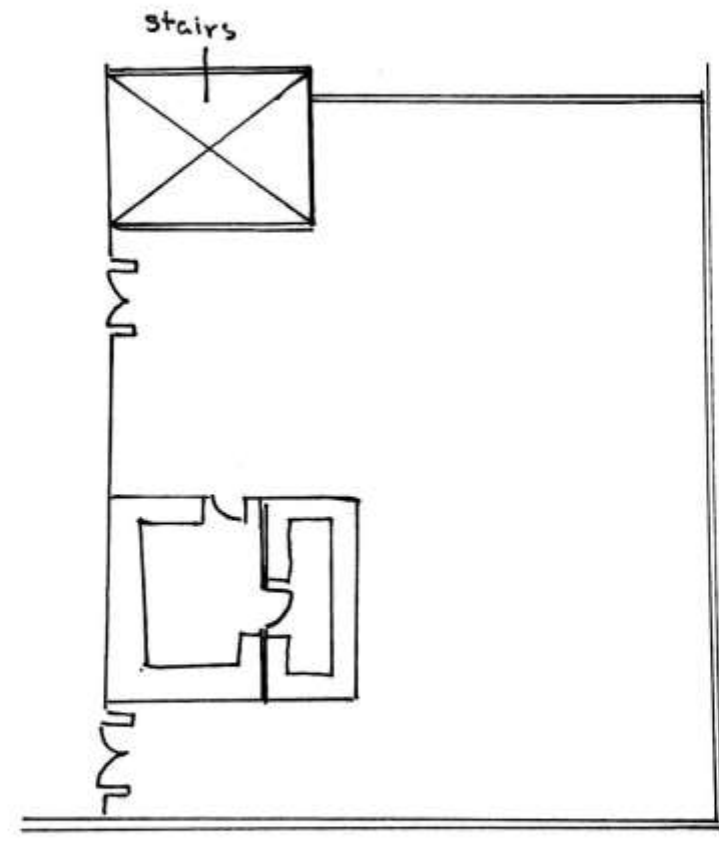

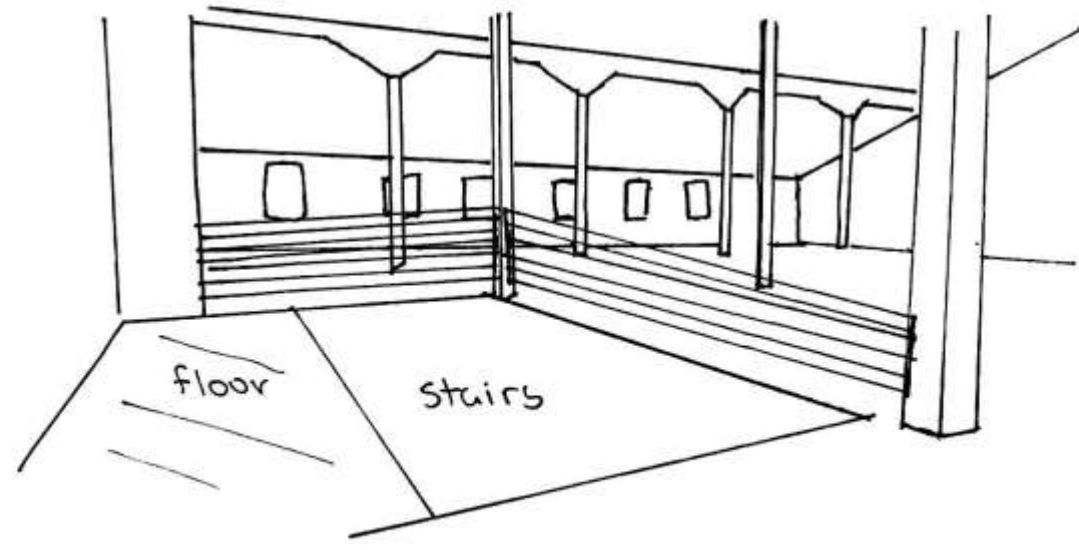

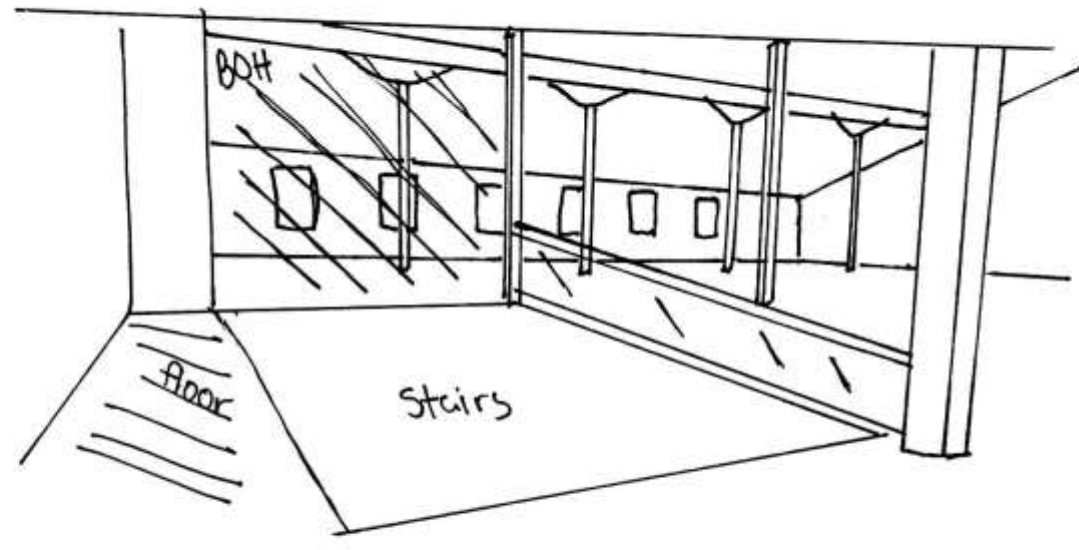
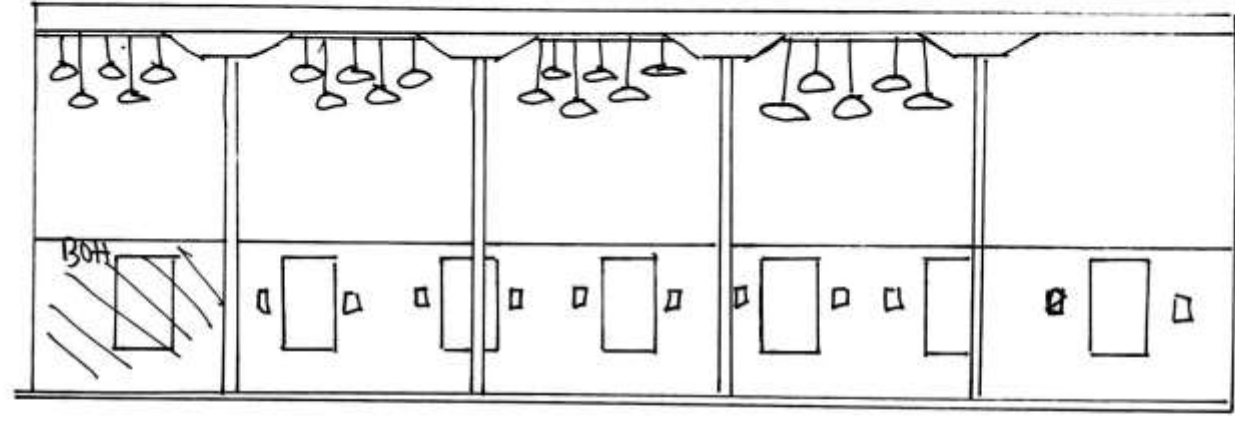
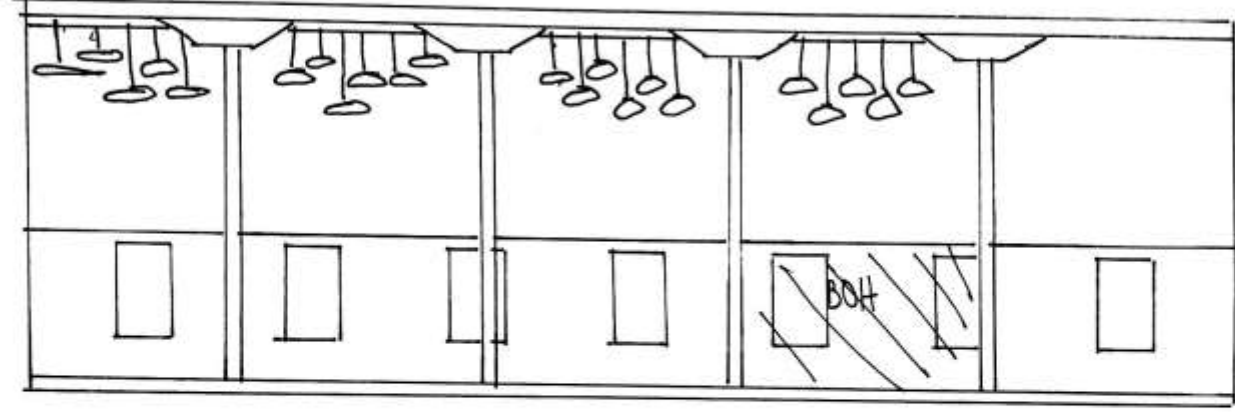
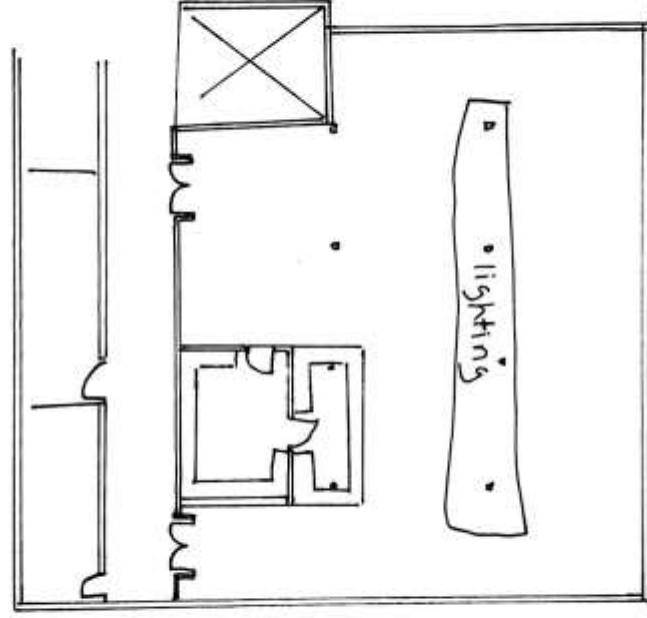
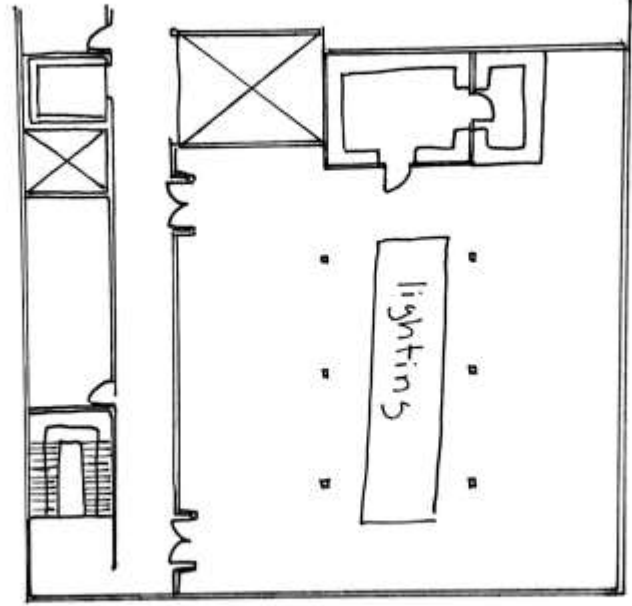
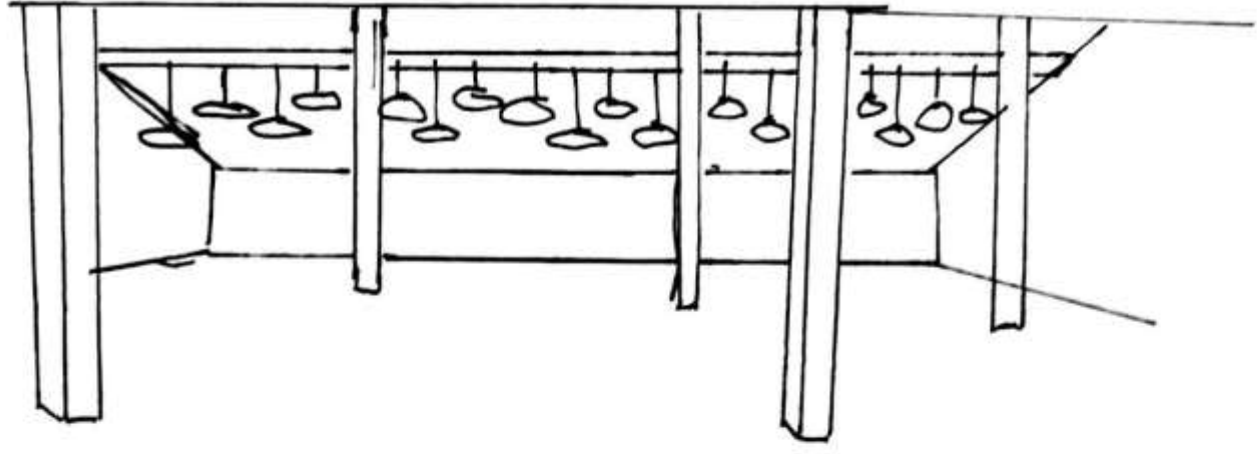
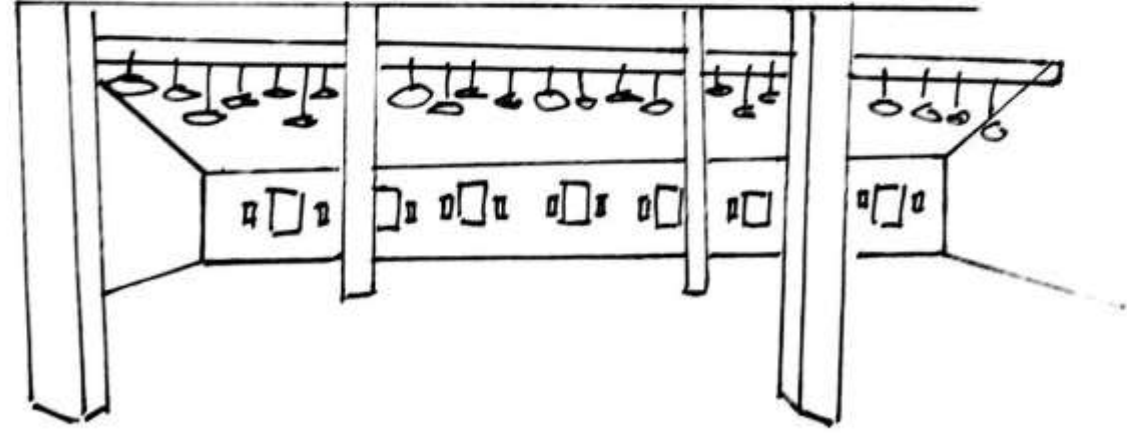
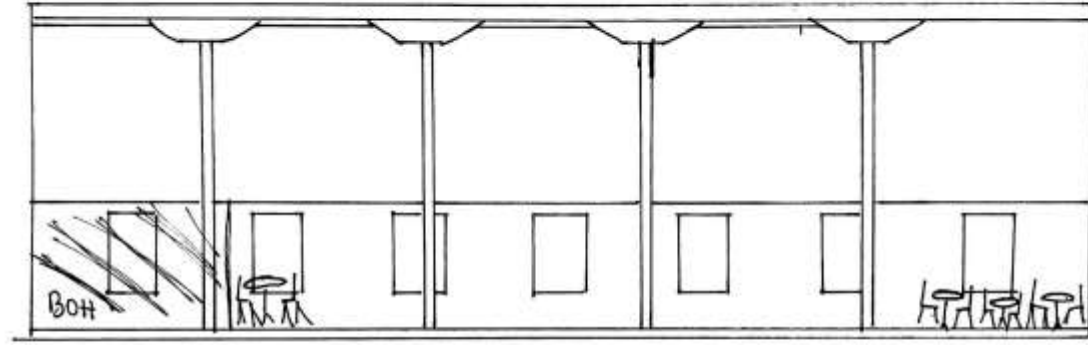
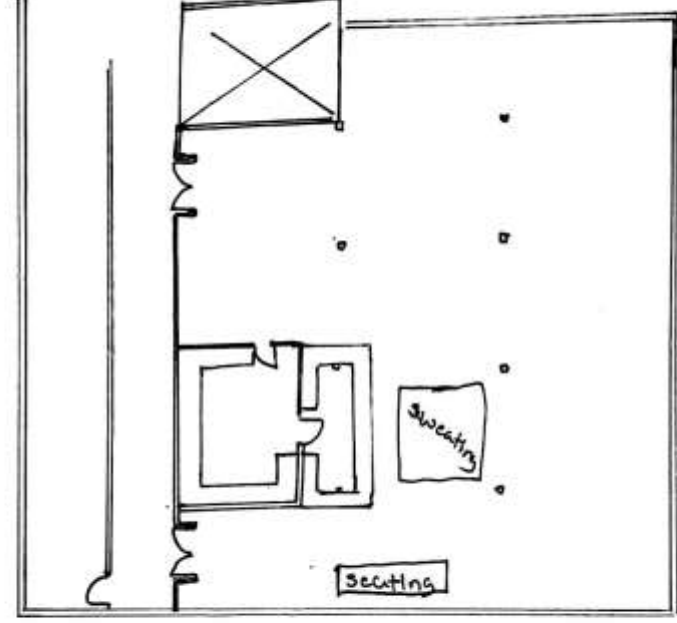
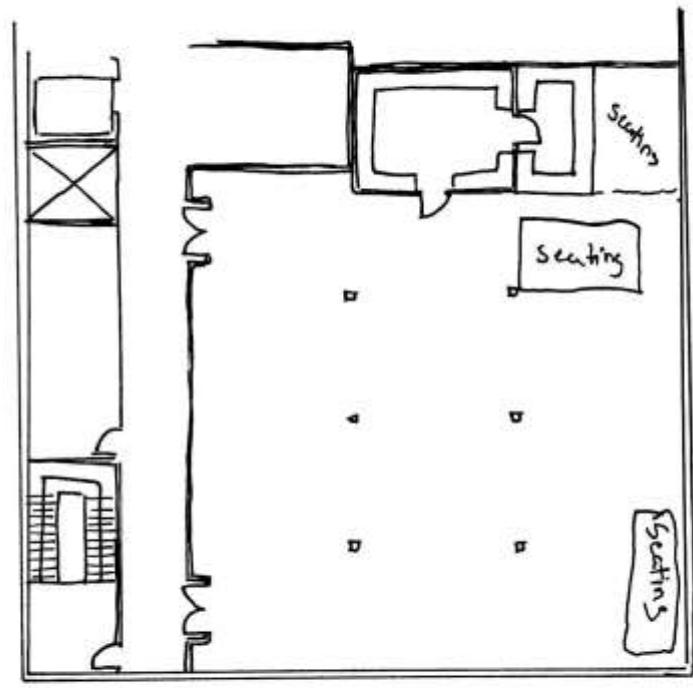
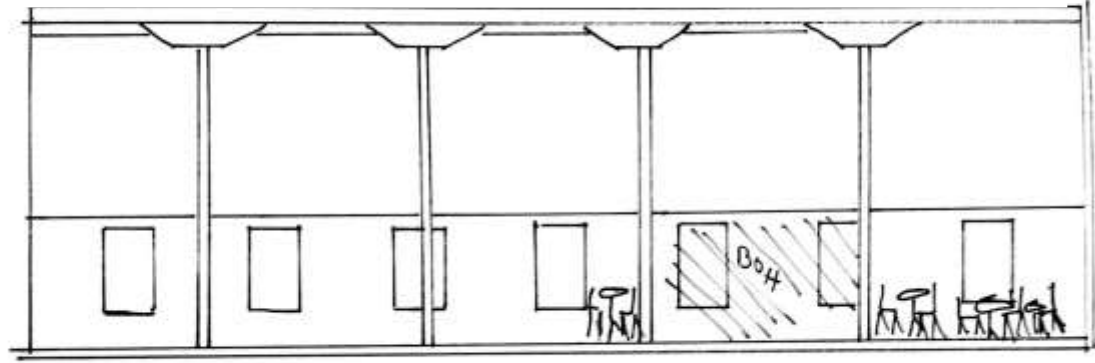
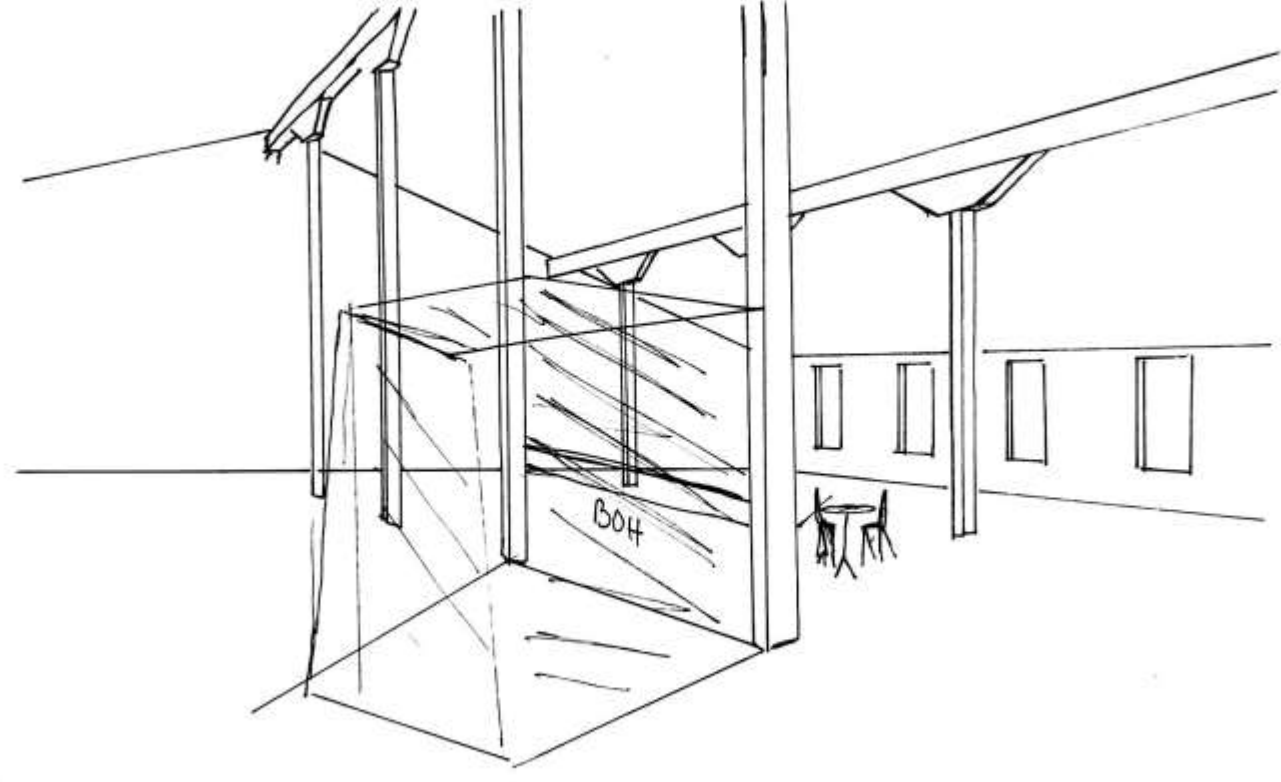
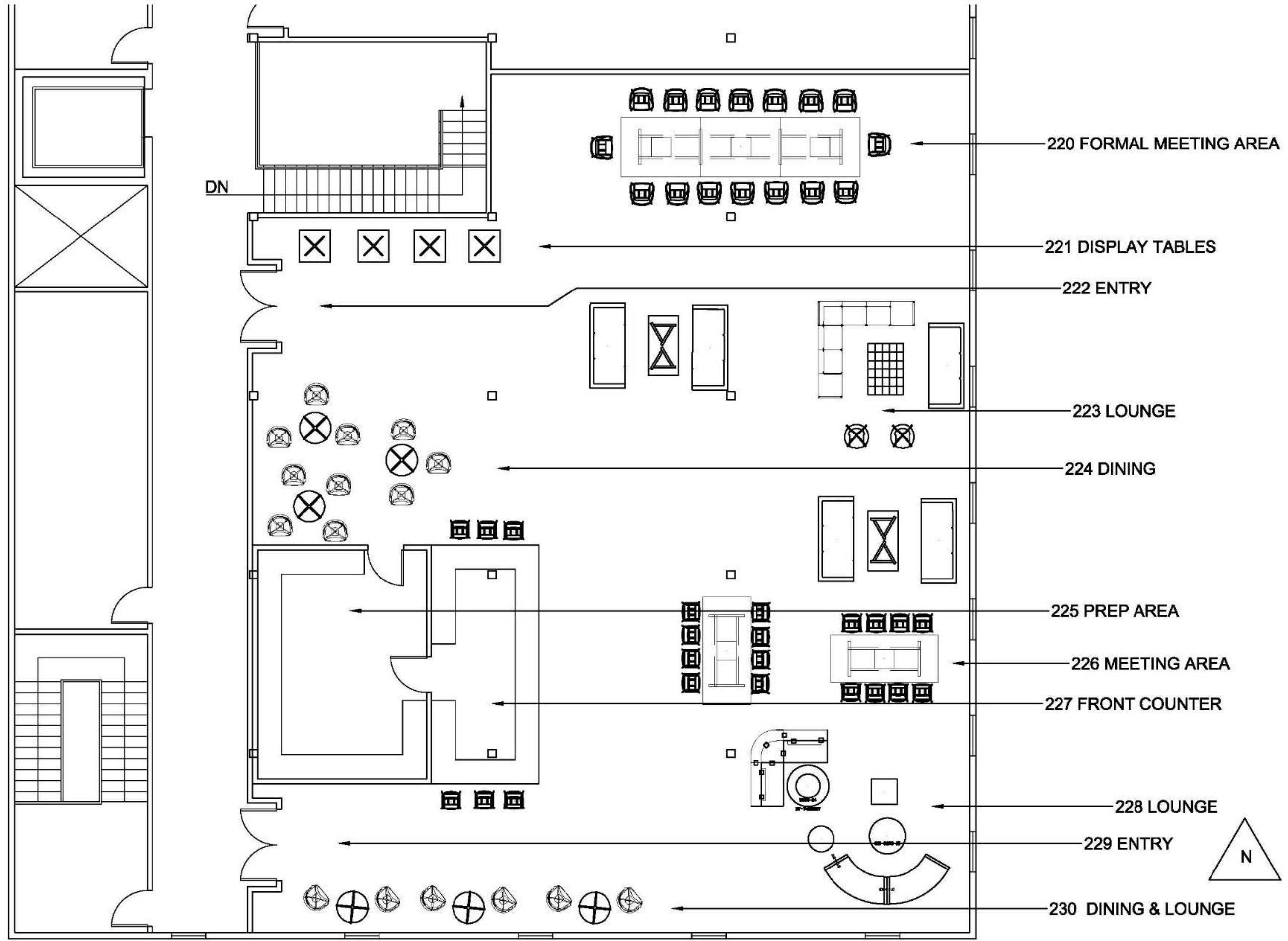



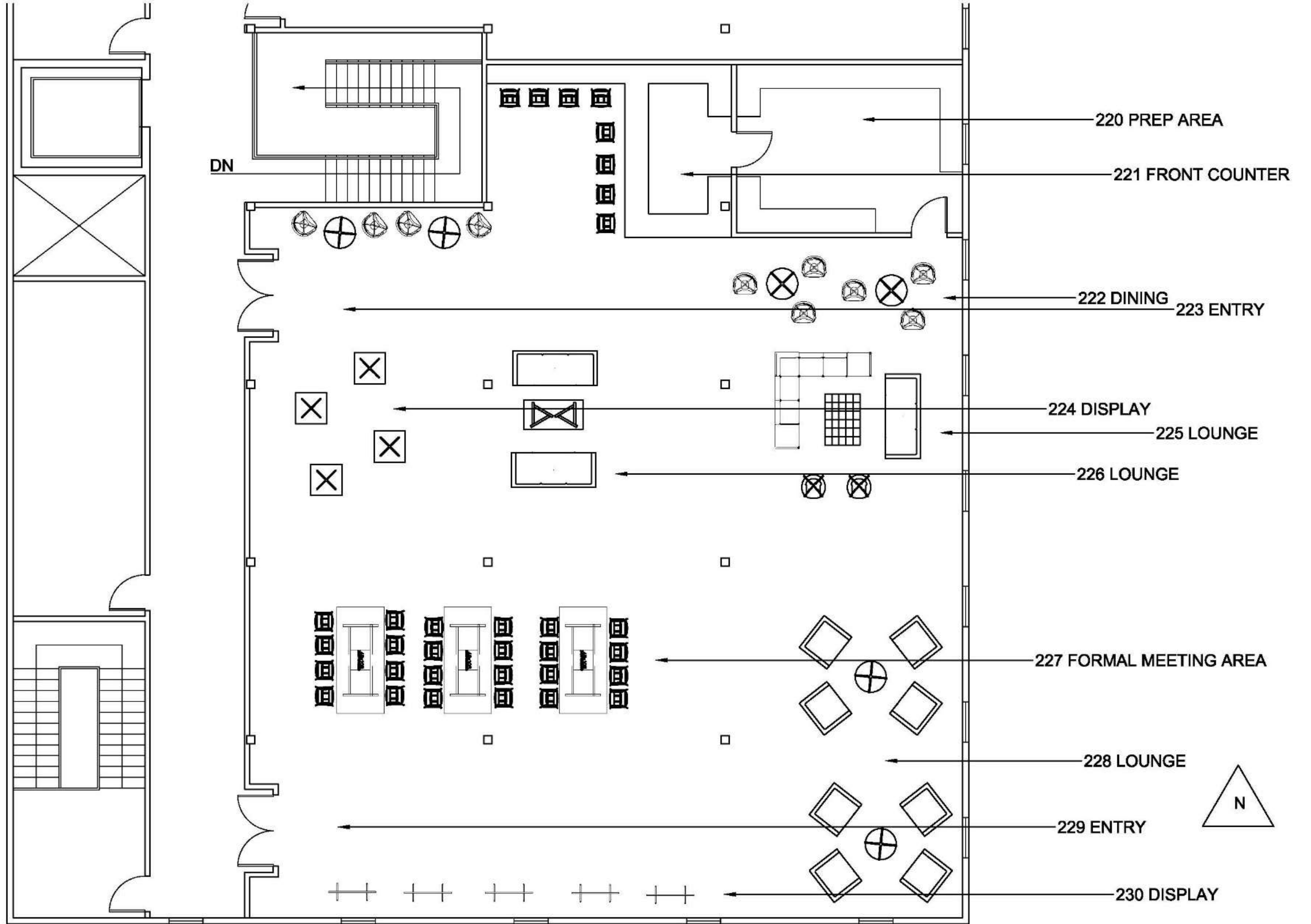



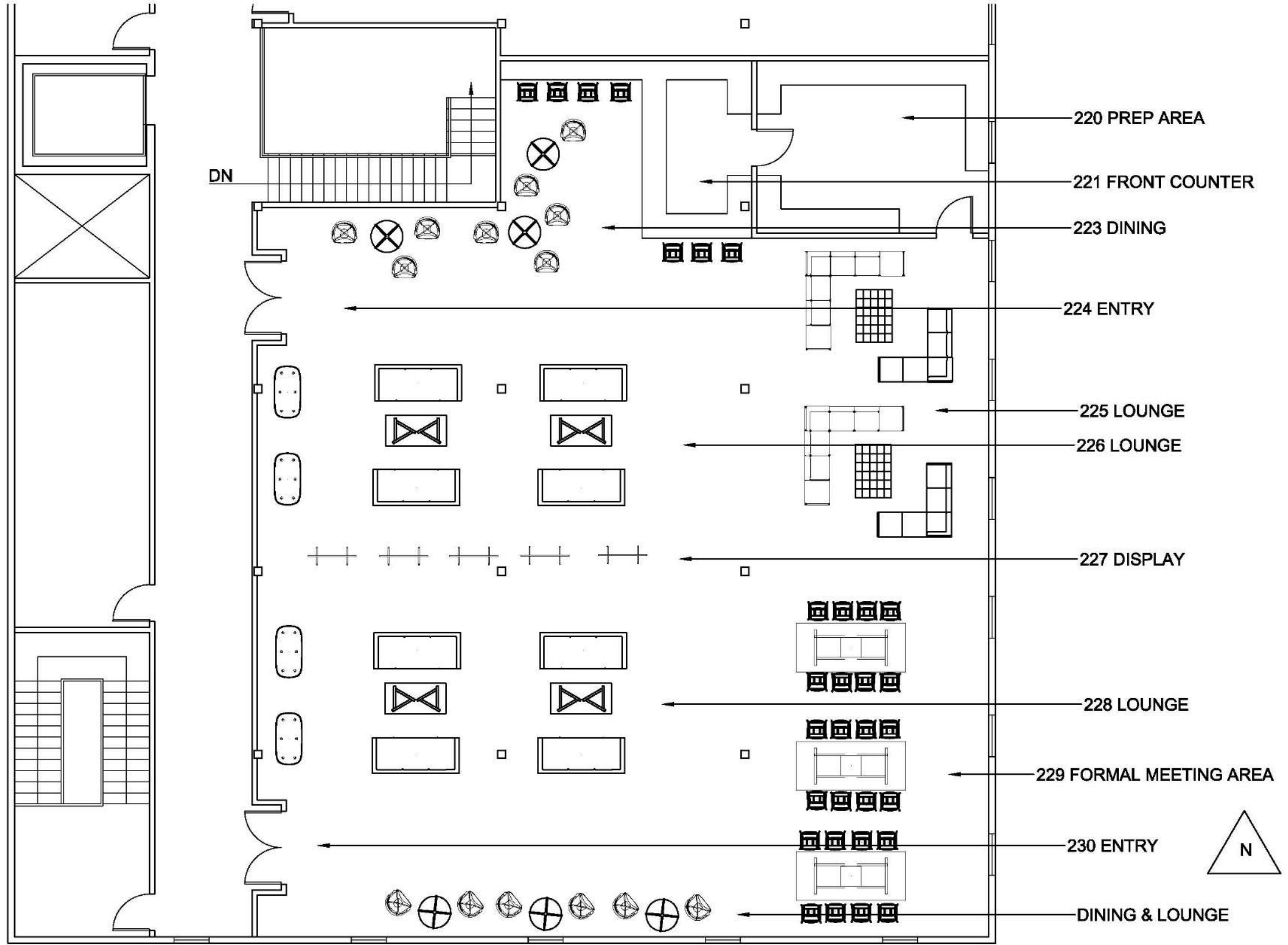

**Rebekah Fry**

**Assignment 11**

**IDSN 2102 F19**

**Scissor Stair**

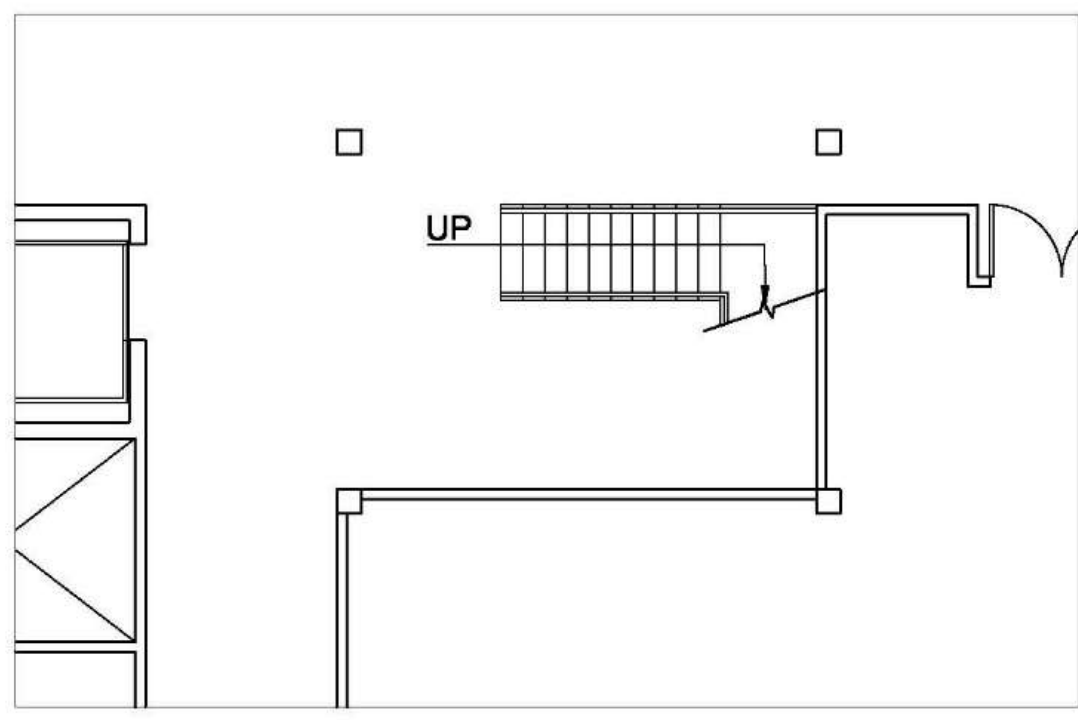
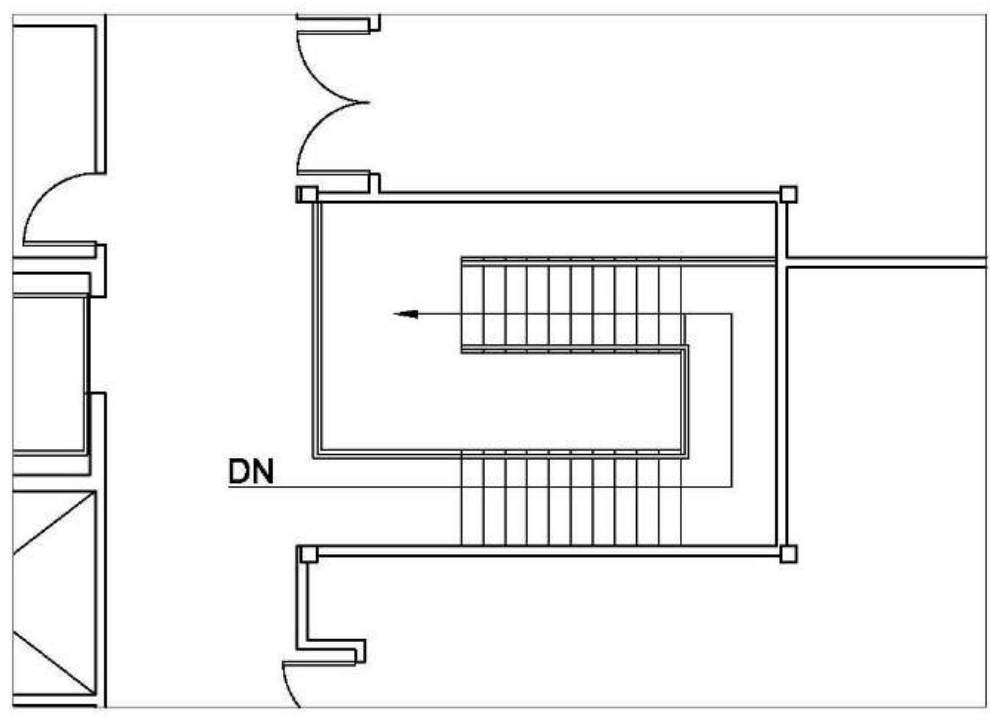
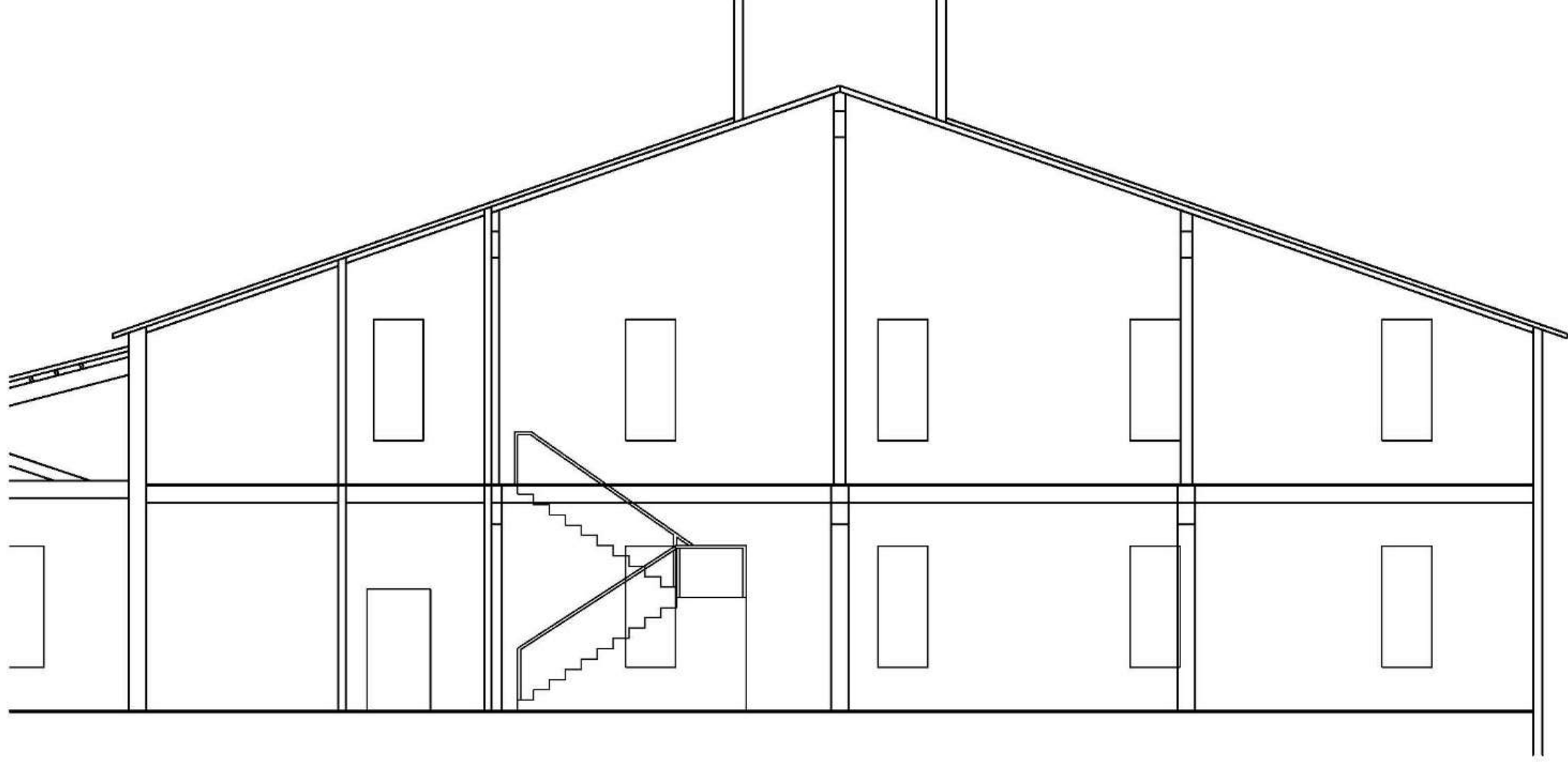

**Rebekah Fry**

**Assignment 11**

**IDSN 2102 F19**

**L-Shaped Stair**

