

---

# ALEXIS JUDY

---

## Portfolio 1

IDSN 2102

Fall 2019

---

# Assignment 1

## Architectural & Engineering Scales

Alexis Judy

IDSN 2102 F19

### Assignment # 1

1) Engineering Scale: 1" = 10'

• Draw the line 34'-0"

• Draw the line 5'-0"

2) Engineering Scale: 1" = 40'

• Draw a line 160'-0"

• Draw a line 245'-0"

3) Engineering Scale: 1" = 200'

• Draw a line 1000'-0"

• Draw a line 400'-0"

4) Engineering Scale: 1" = 50'

• Draw a line 110'-0"

• Draw a line 60'-0"

5) Architectural Scale: Full

• Draw a line 6'-7/8"

• Draw a line 9'-3/8"

### Assignment # 1 Continued...

Architectural Scale

6) Draw a line 1/4" = 1'-0"

• Draw a line 24'-8"

• Draw a line 30'-6"

7) Draw a line 1/8" = 1'-0"

• Draw a line 44'-4"

• Draw a line 61'-0"

8) Draw a line 1" = 1'-0"

• Draw a line 4'-6"

• Draw a line 0'-8"

9) Draw a line 3/4" = 1'-0"

• Draw a line 6'-9"

• Draw a line 2'-0"

# Assignment 2

Quick Sketch Competencies

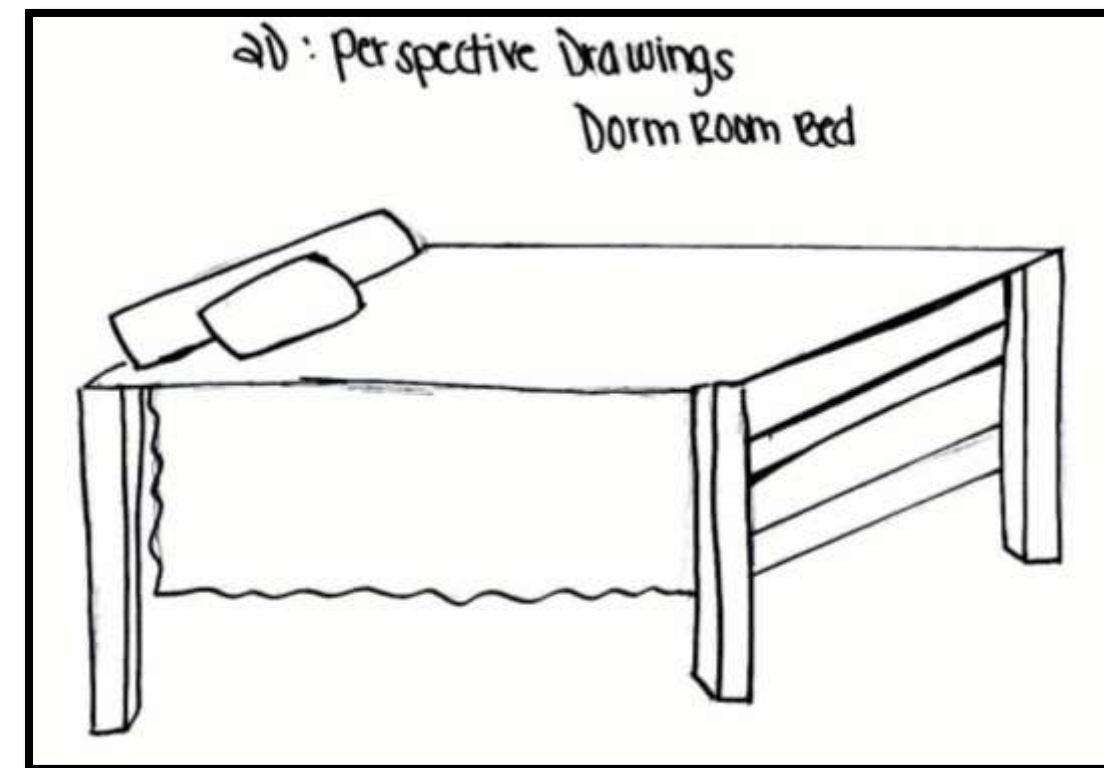
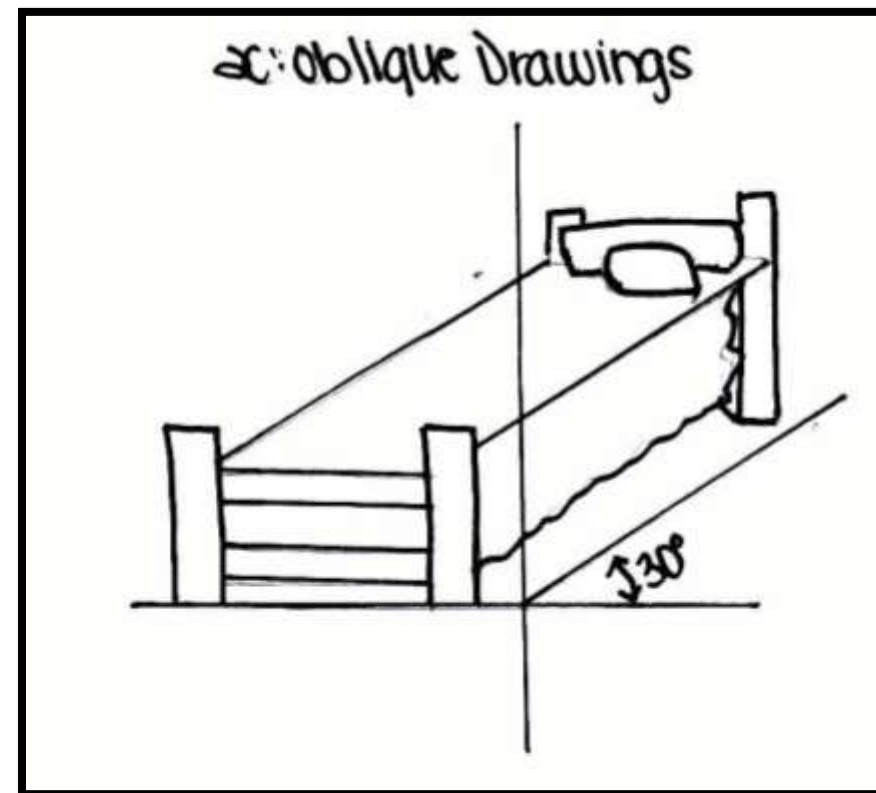
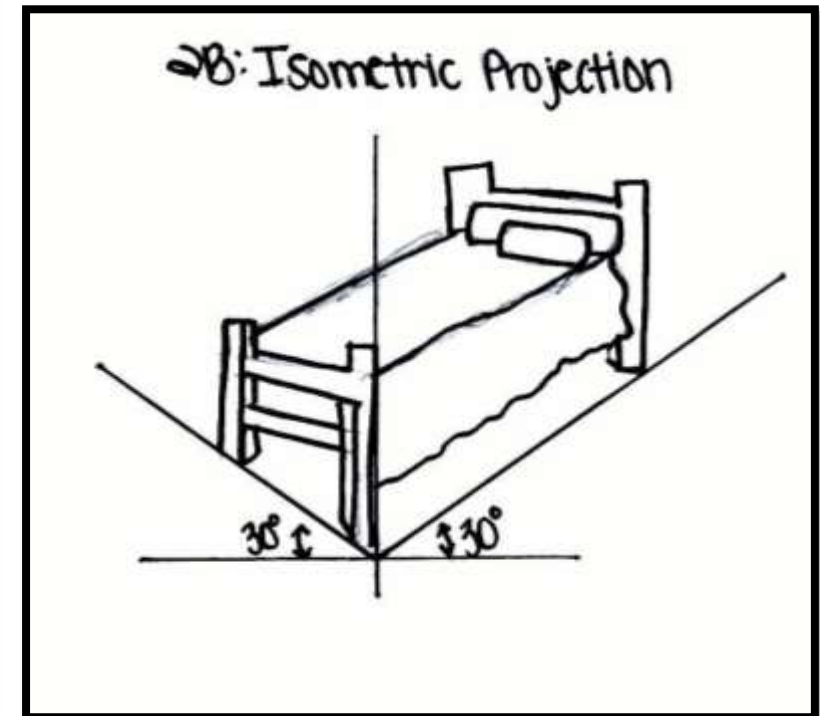
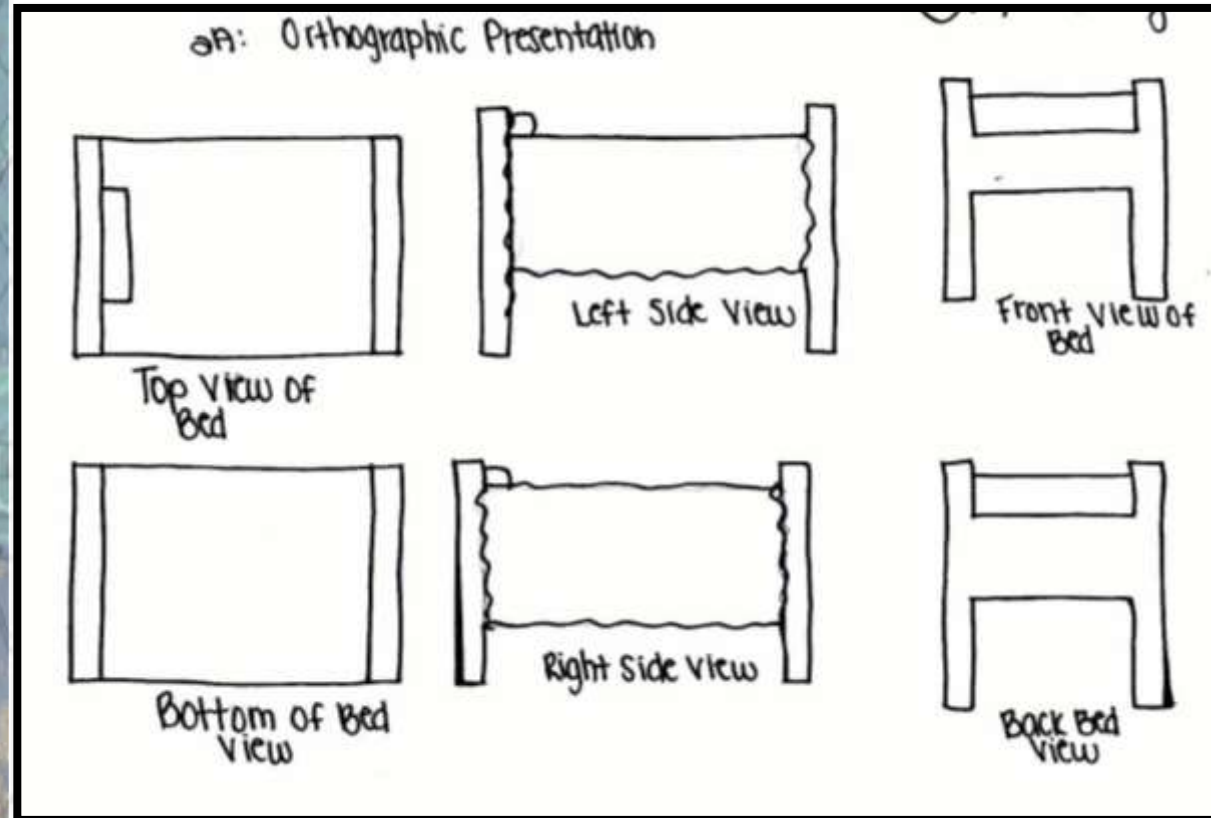

Alexis Judy

IDSN 2102 F19

# Assignment 3

Activity Space Studies:  
Area by myself

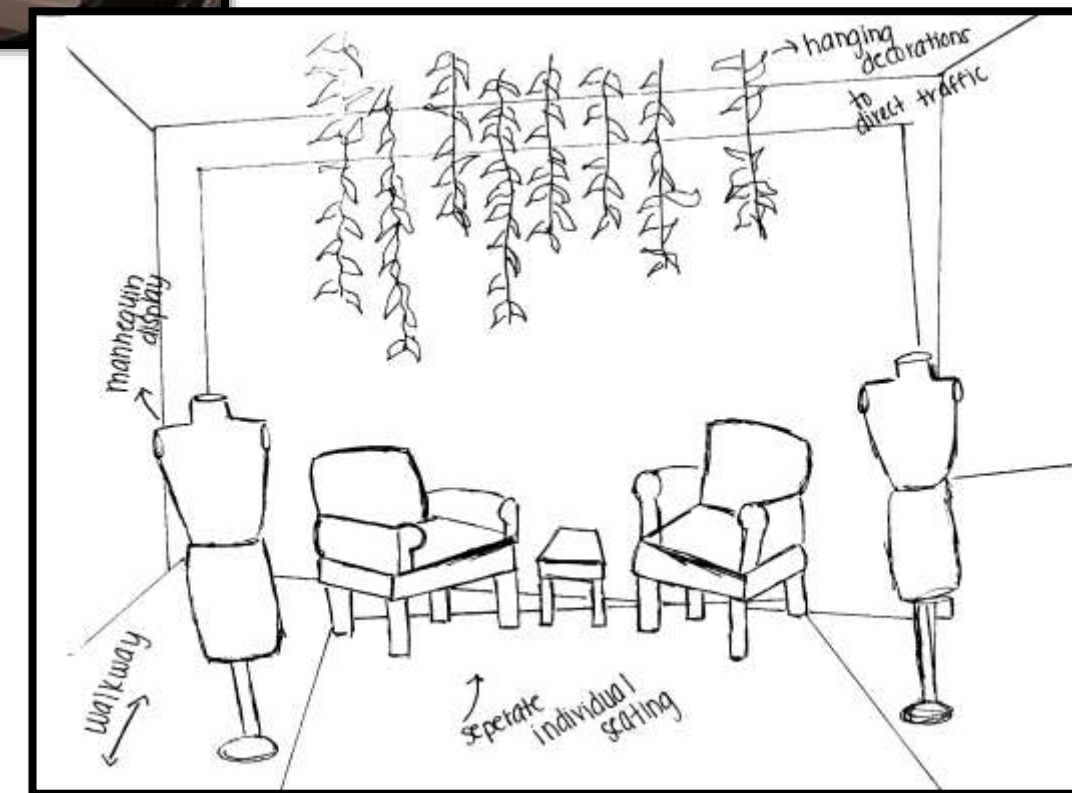
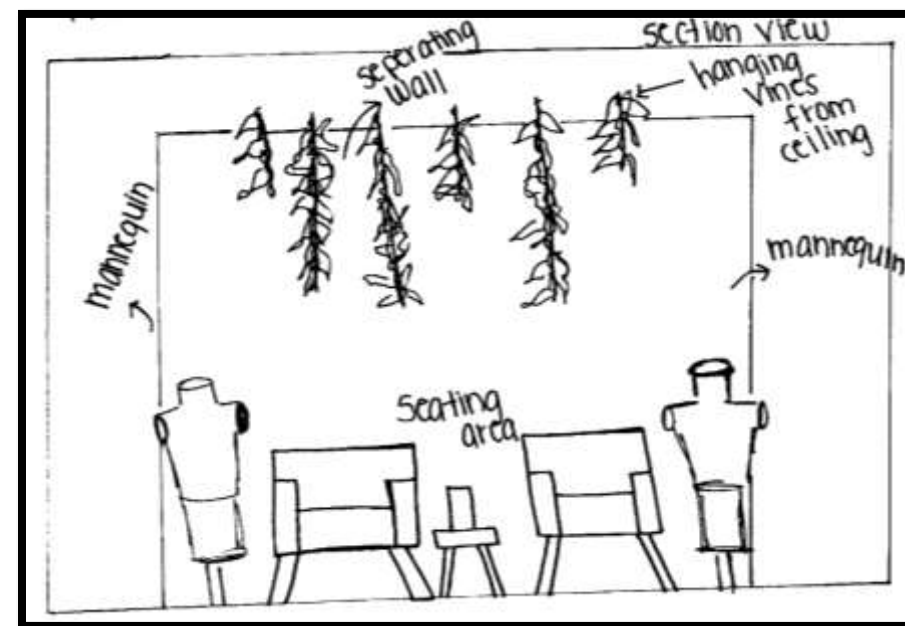
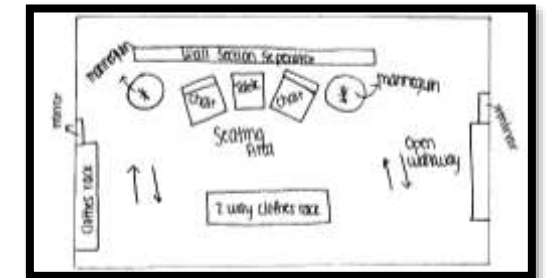
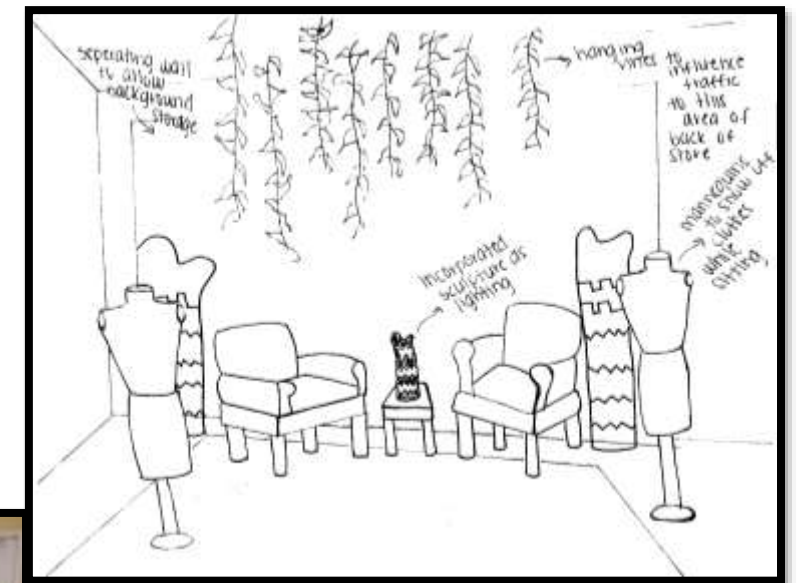
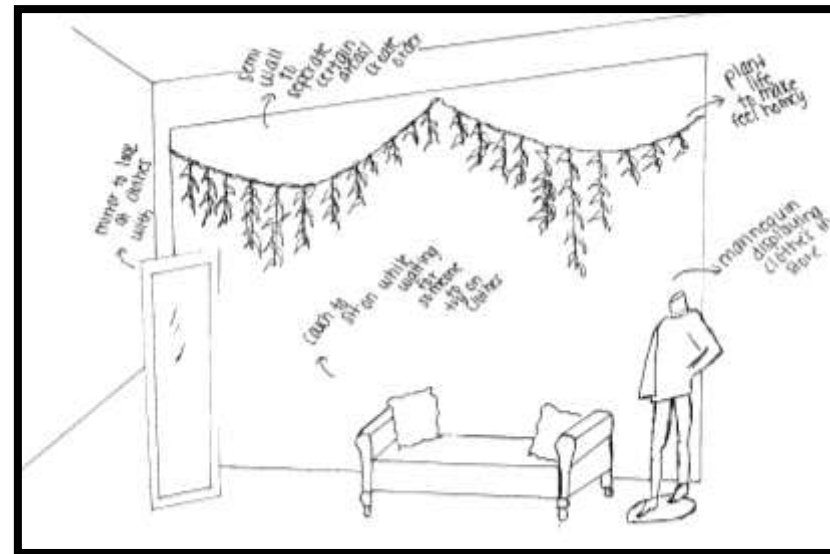

Alexis Judy  
IDSN 2102 F19

# Assignment 3

Activity Space Studies:  
Area with friends

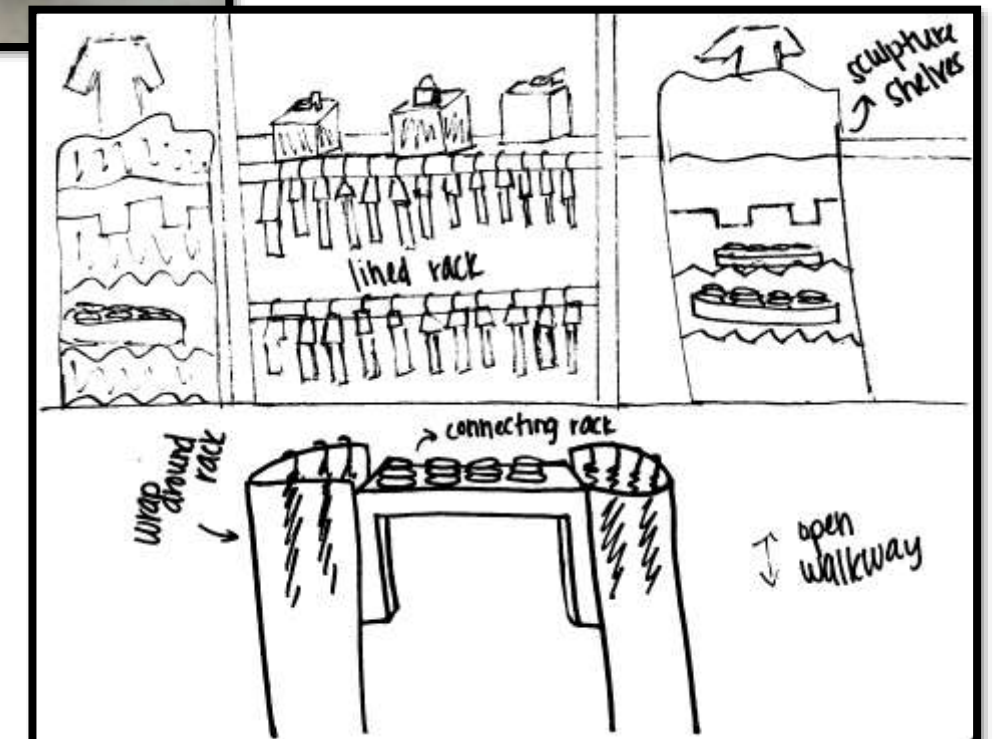
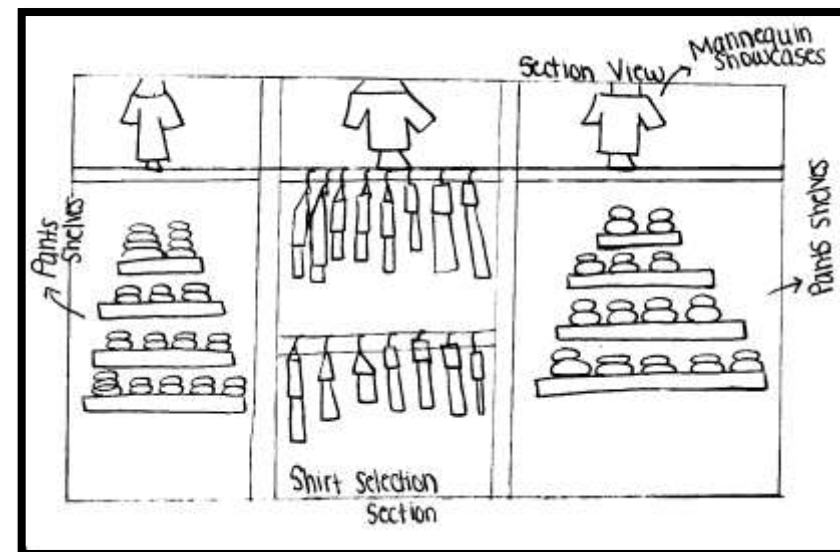
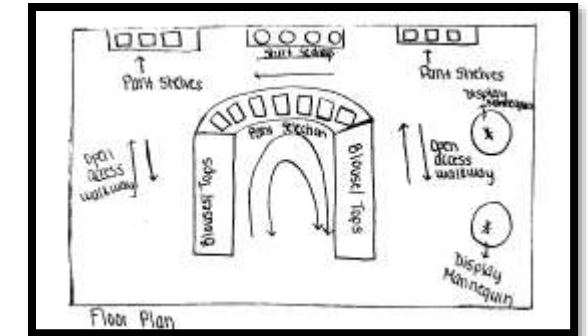
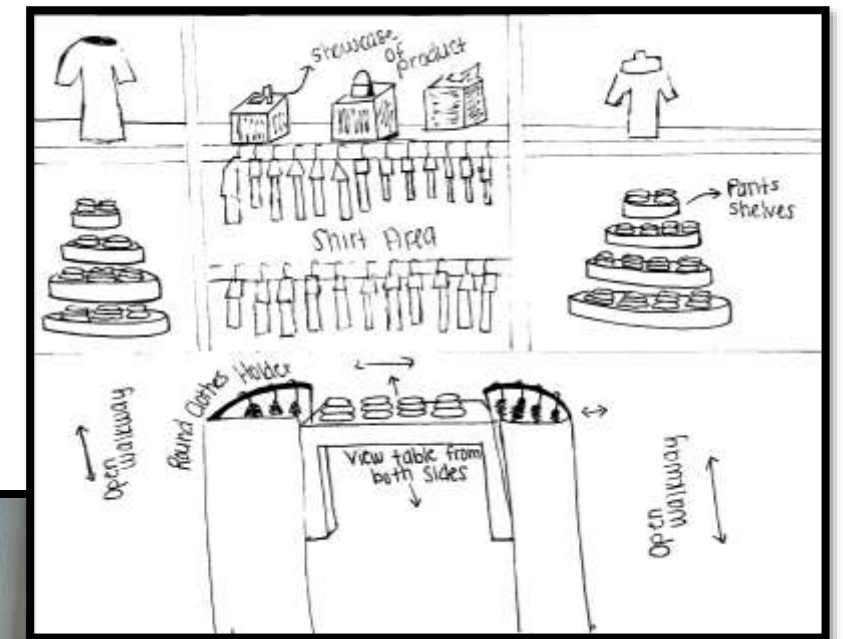
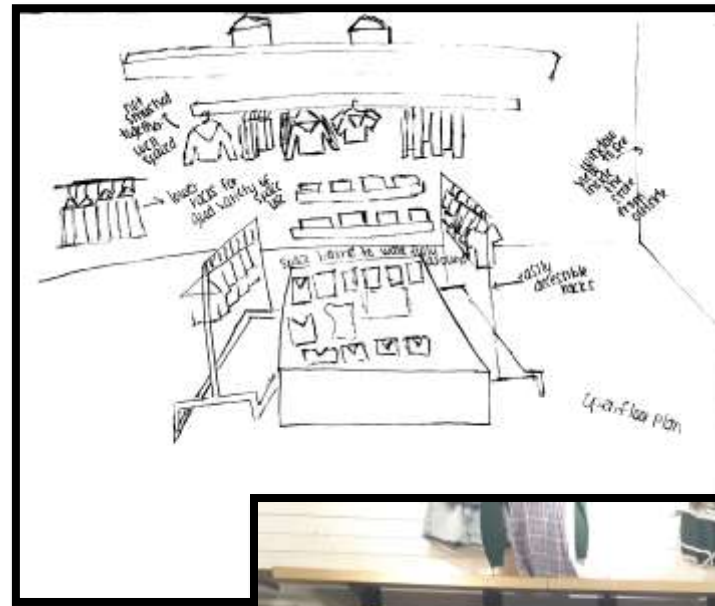

Alexis Judy  
IDSN 2102 F19

# Assignment 3

Activity Space Studies:  
Having Coffee

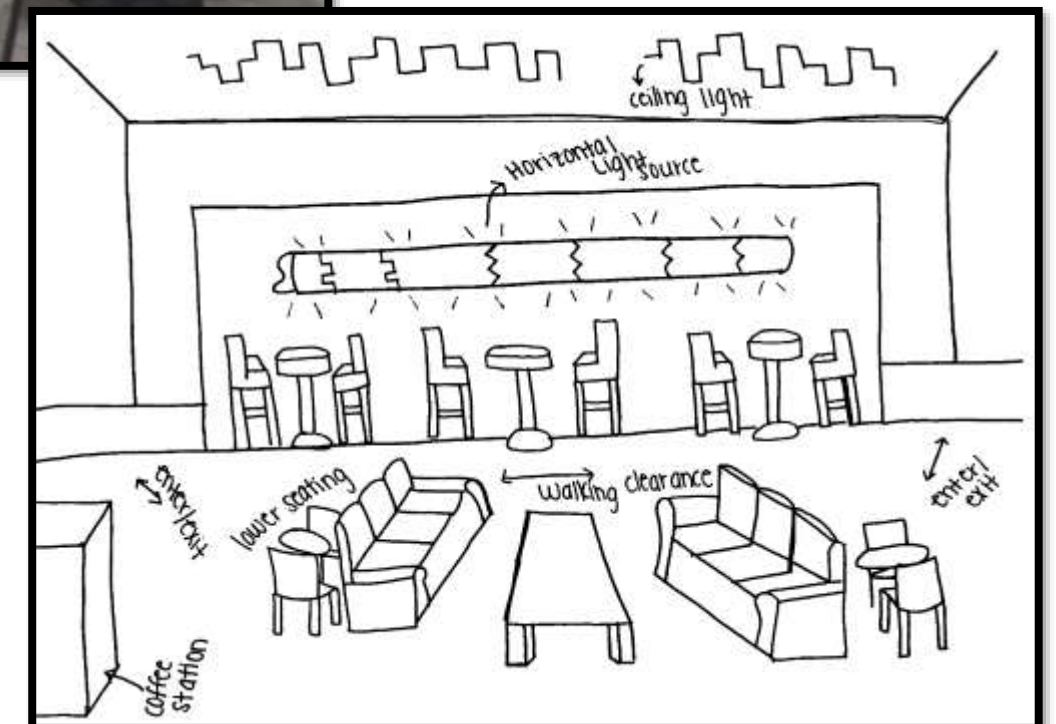
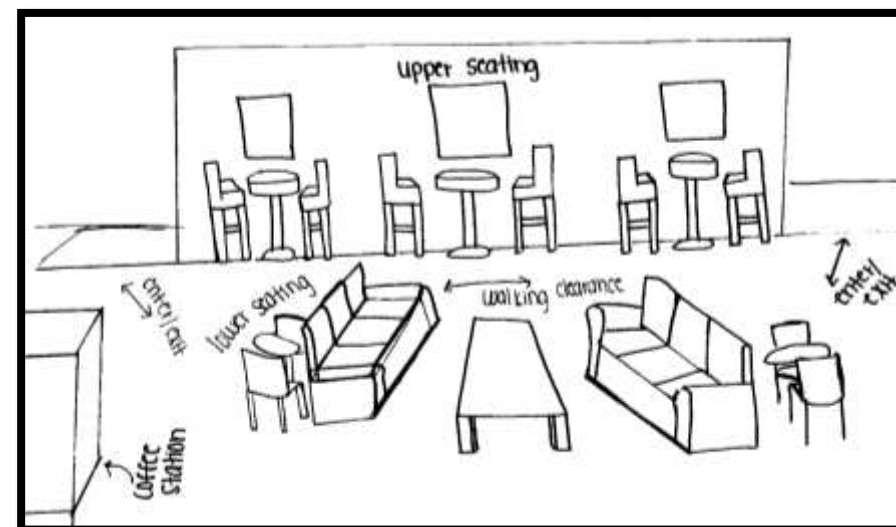
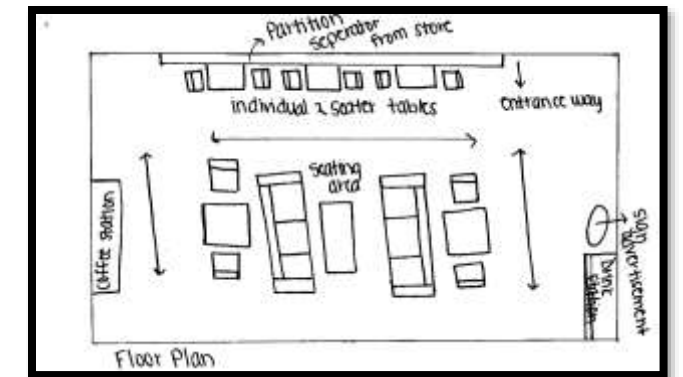
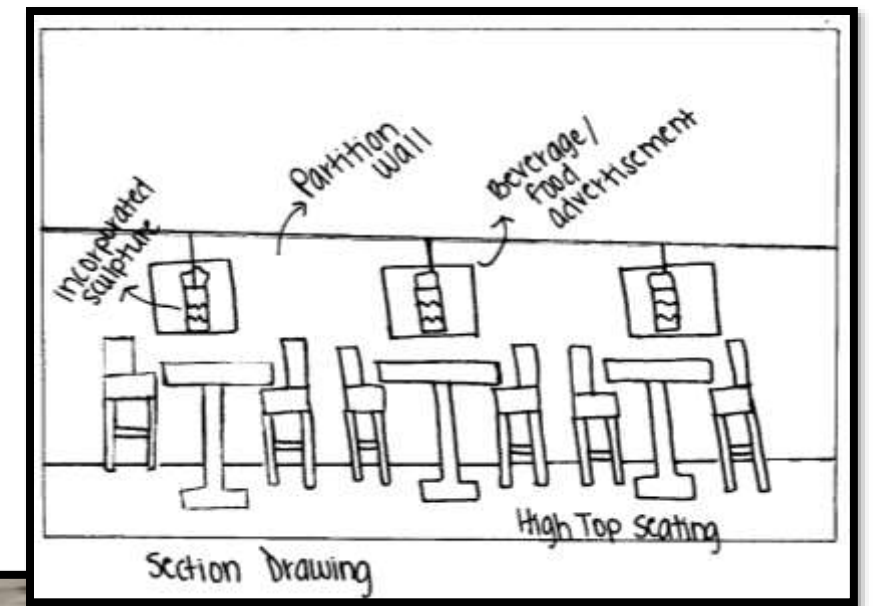
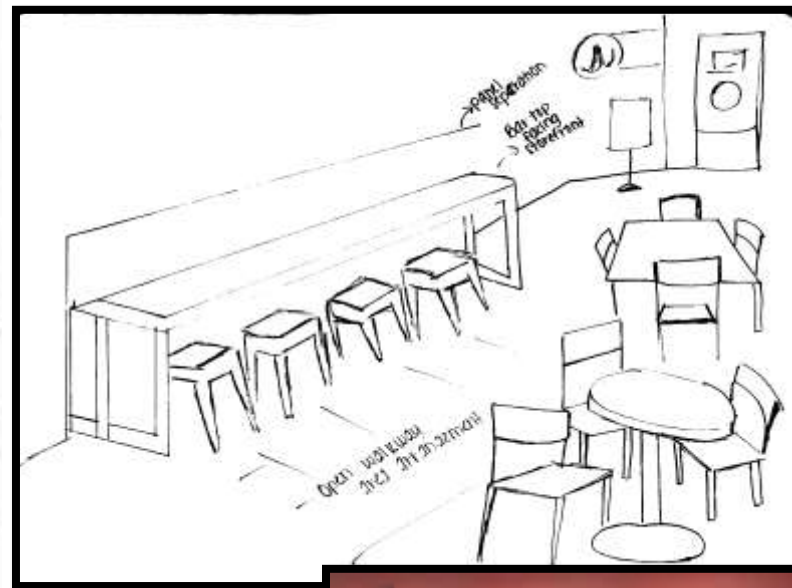

Alexis Judy  
IDSN 2102 F19

# Assignment 4

*Drawing to Music*

**Alexis Judy**

**IDSN 2102 F19**

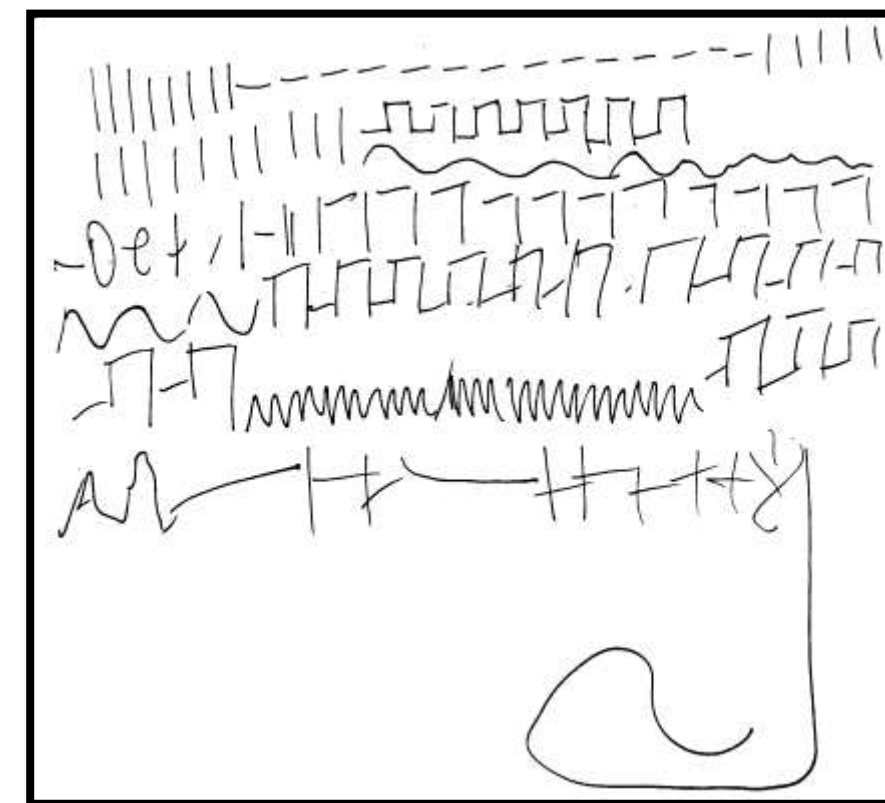
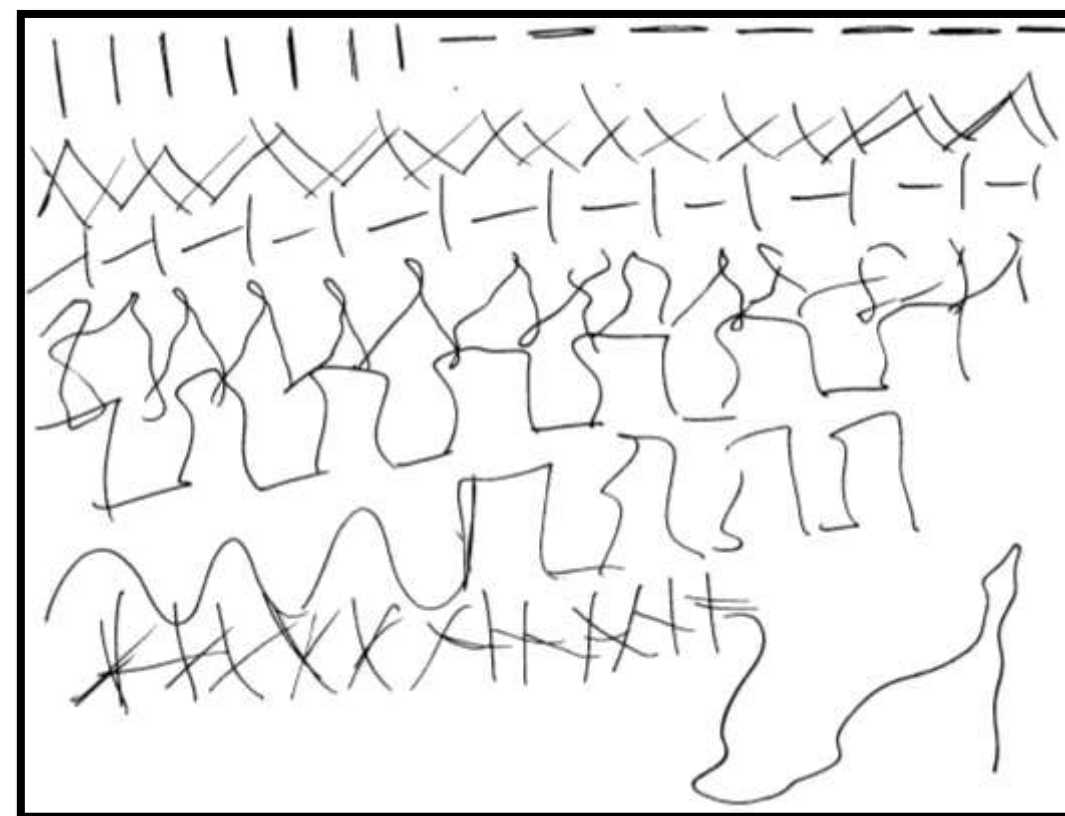
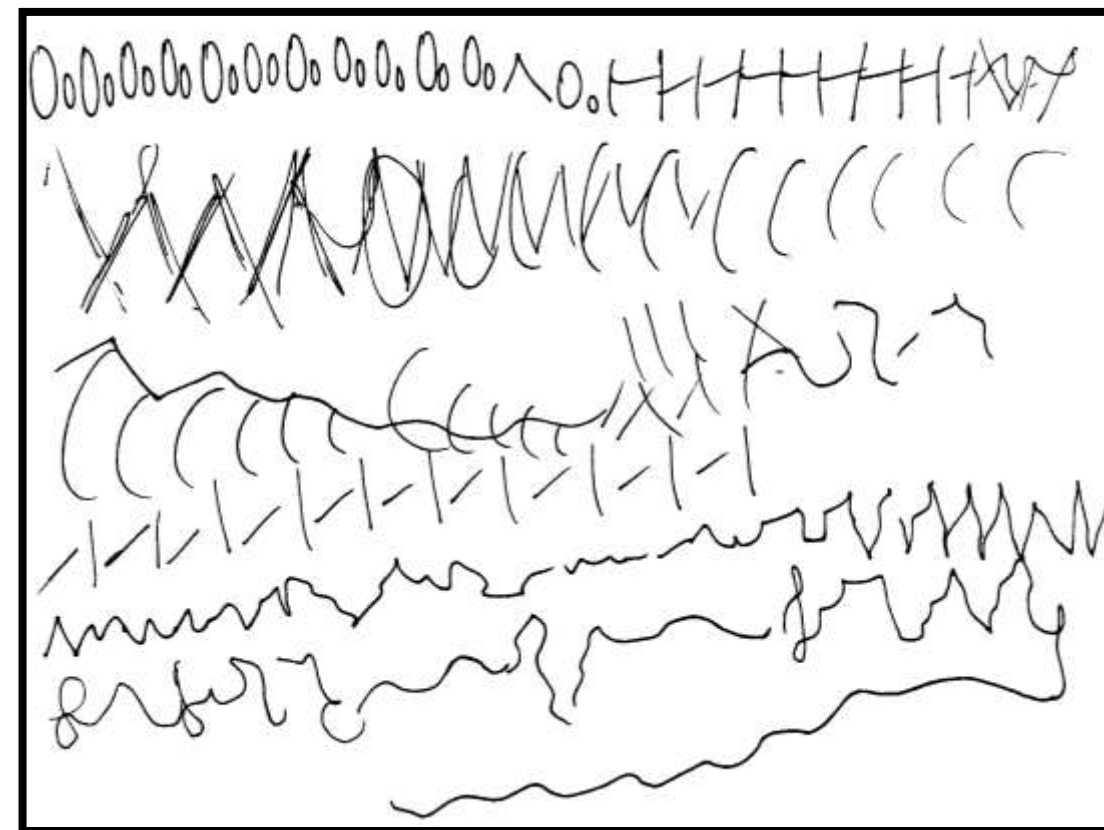
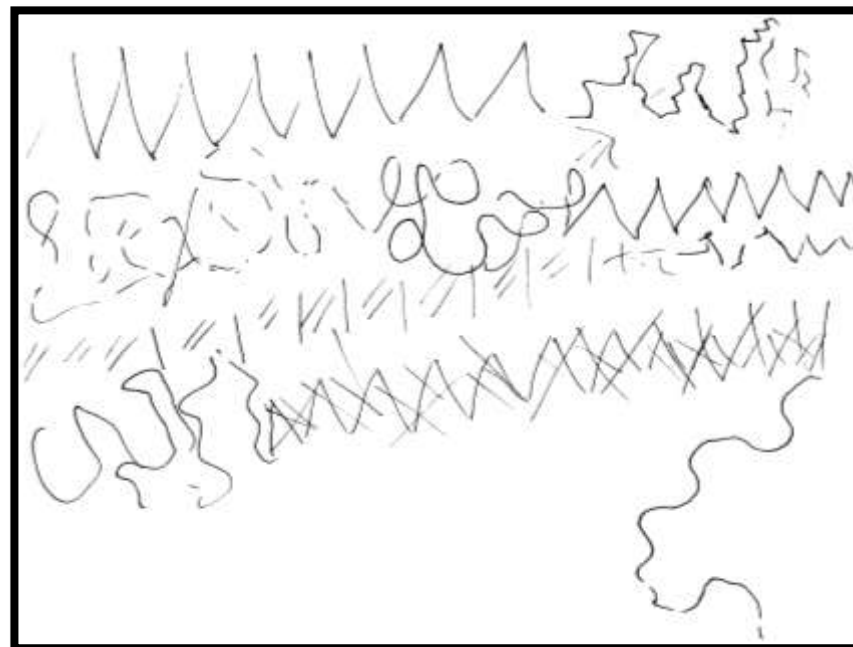

# Assignment 5

*Modeling to Music*

**Alexis Judy**

**IDSN 2102 F19**

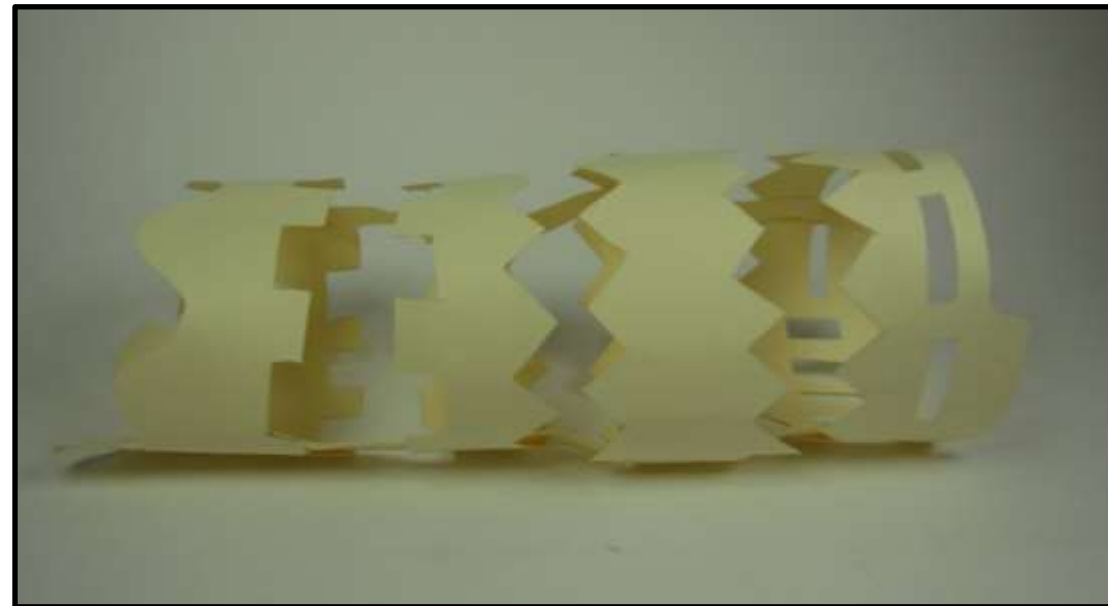
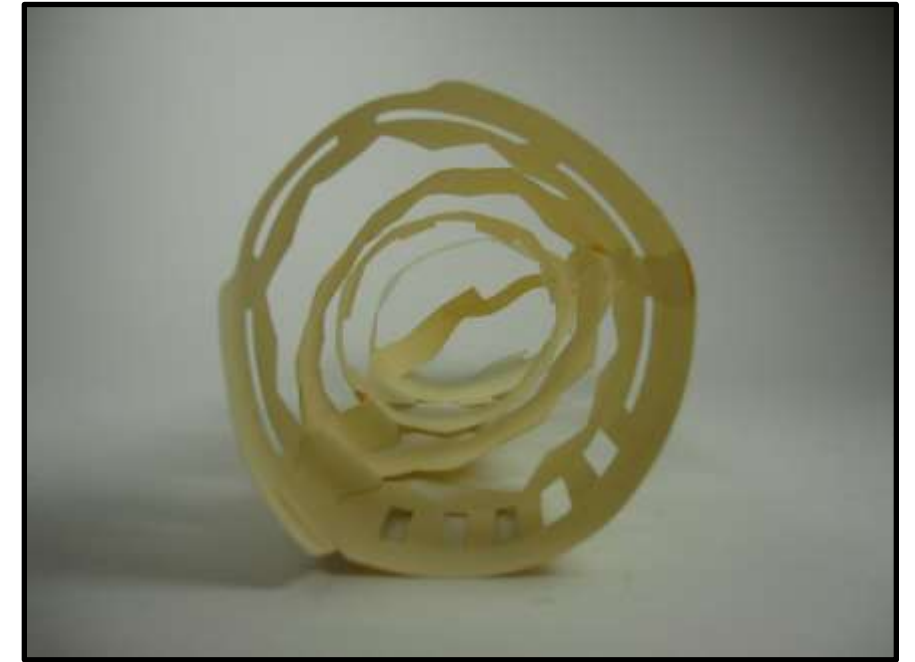



# Assignment 6

*AutoCAD- Circulation Plans  
Floor Plan #1*

**Alexis Judy**

**IDSN 2102 F19**

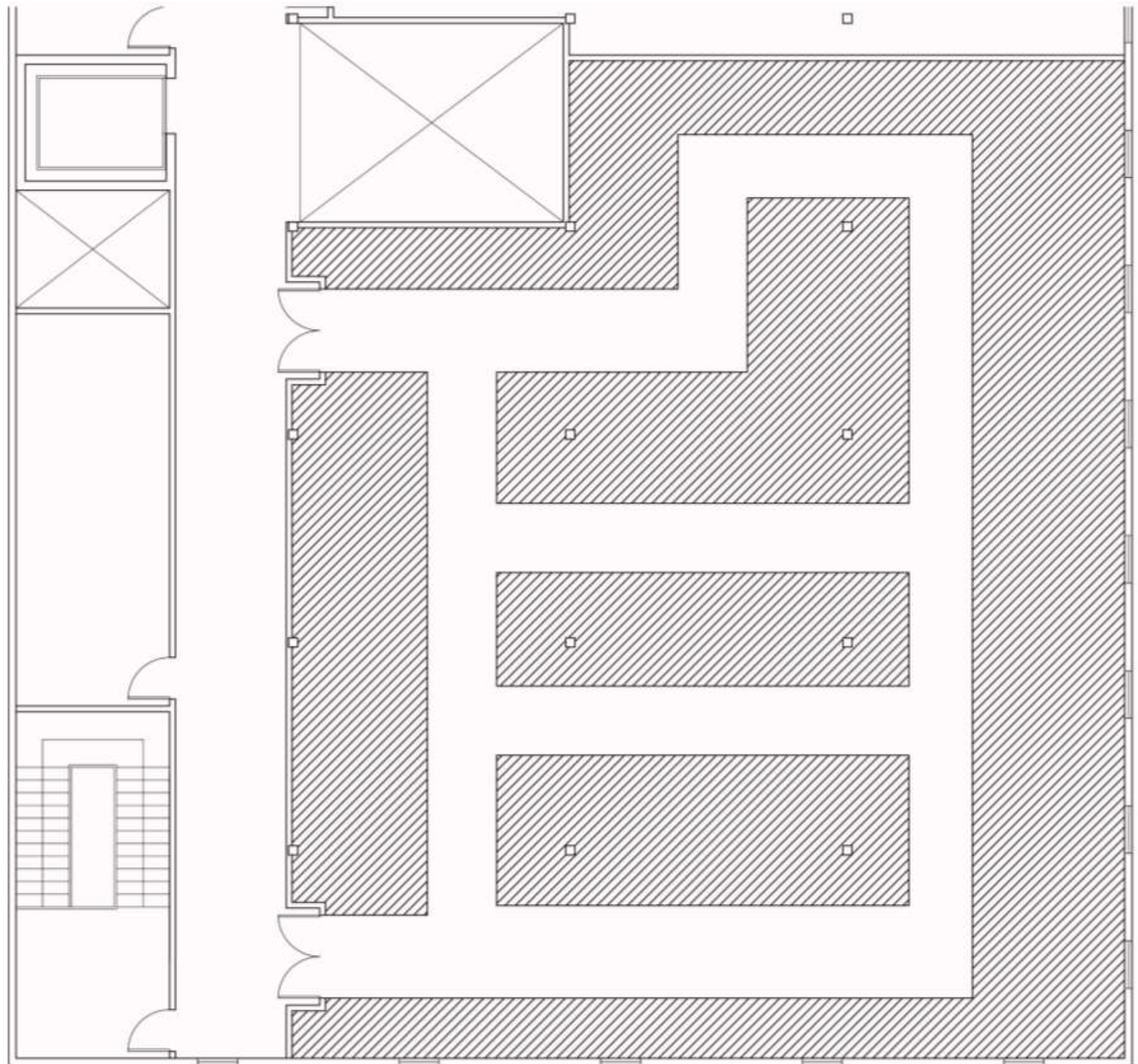

# Assignment 6

*AutoCAD- Circulation Plans  
Floor Plan #2*

**Alexis Judy**

**IDSN 2102 F19**

