



Julia Quayle

Portfolio 2

IDSN 2102 F19

ASSIGNMENTS 7&8

Idea for kitchen
& service
counter
floorplans

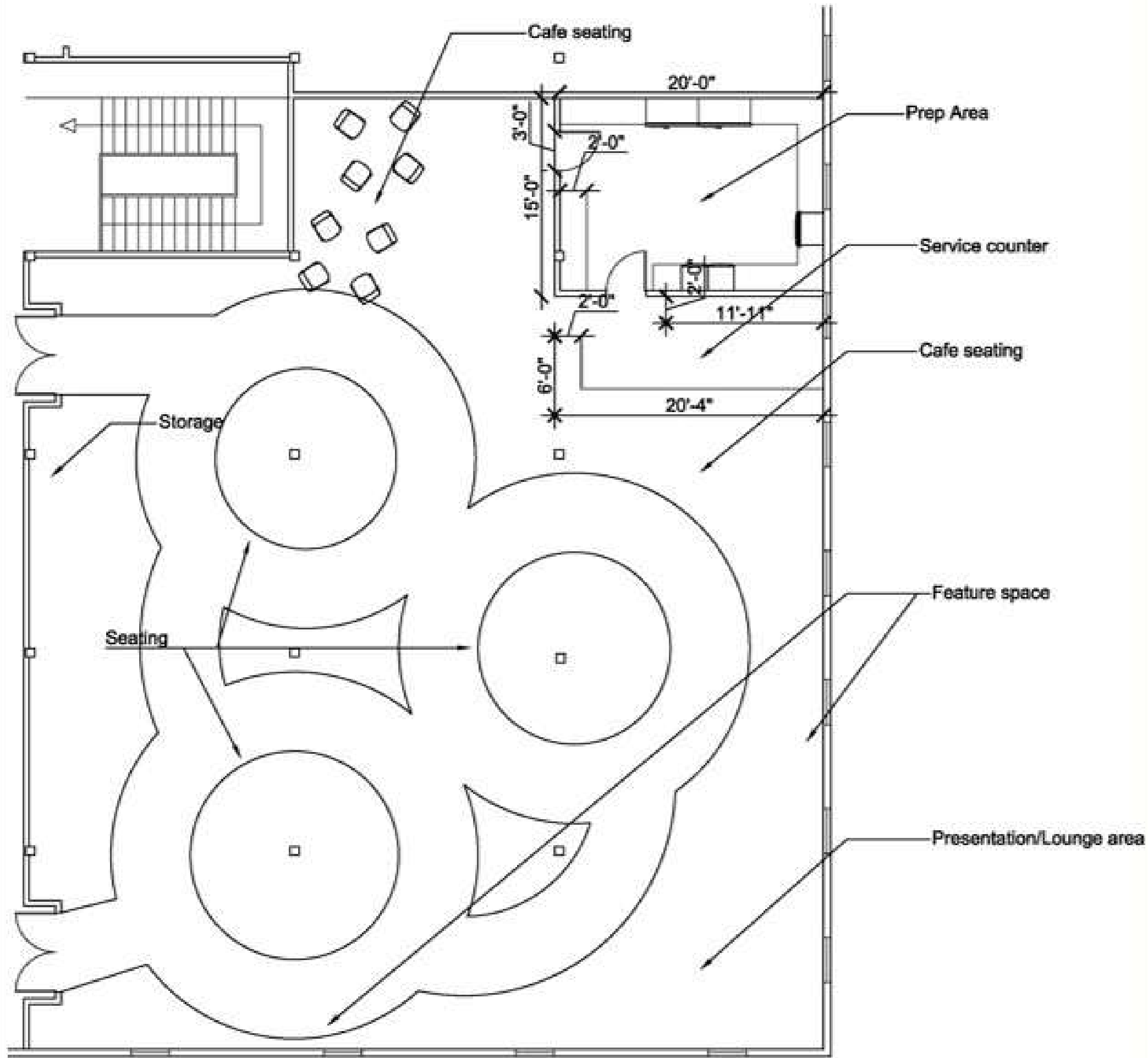

Julia Quayle

IDSN 2102 F19

ASSIGNMENTS 7&8

Idea for kitchen
& service
counter
floorplans

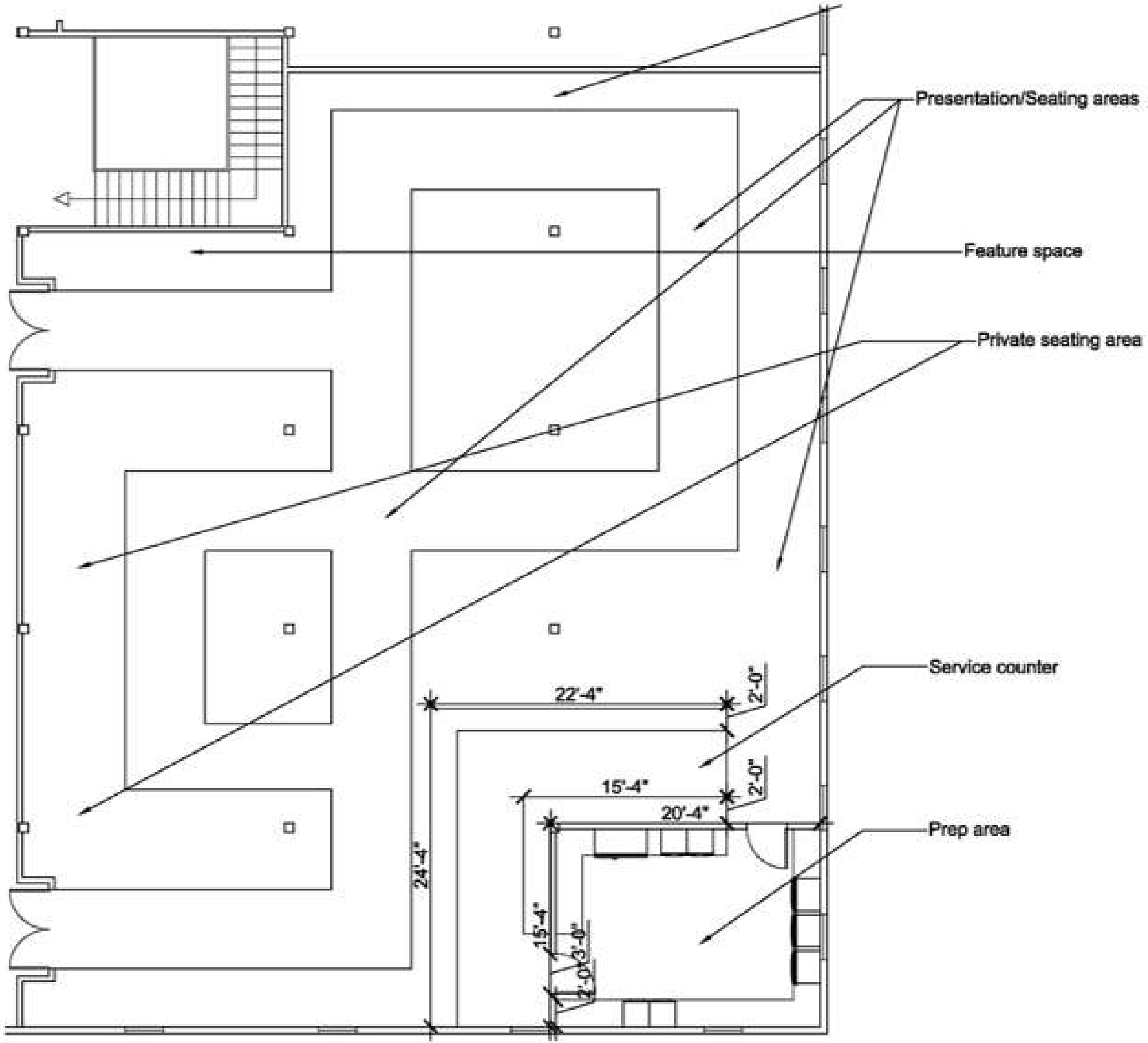

Julia Quayle

IDSN 2102 F19

ASSIGNMENT 9

Problem solving for wayfinding issues in the space.

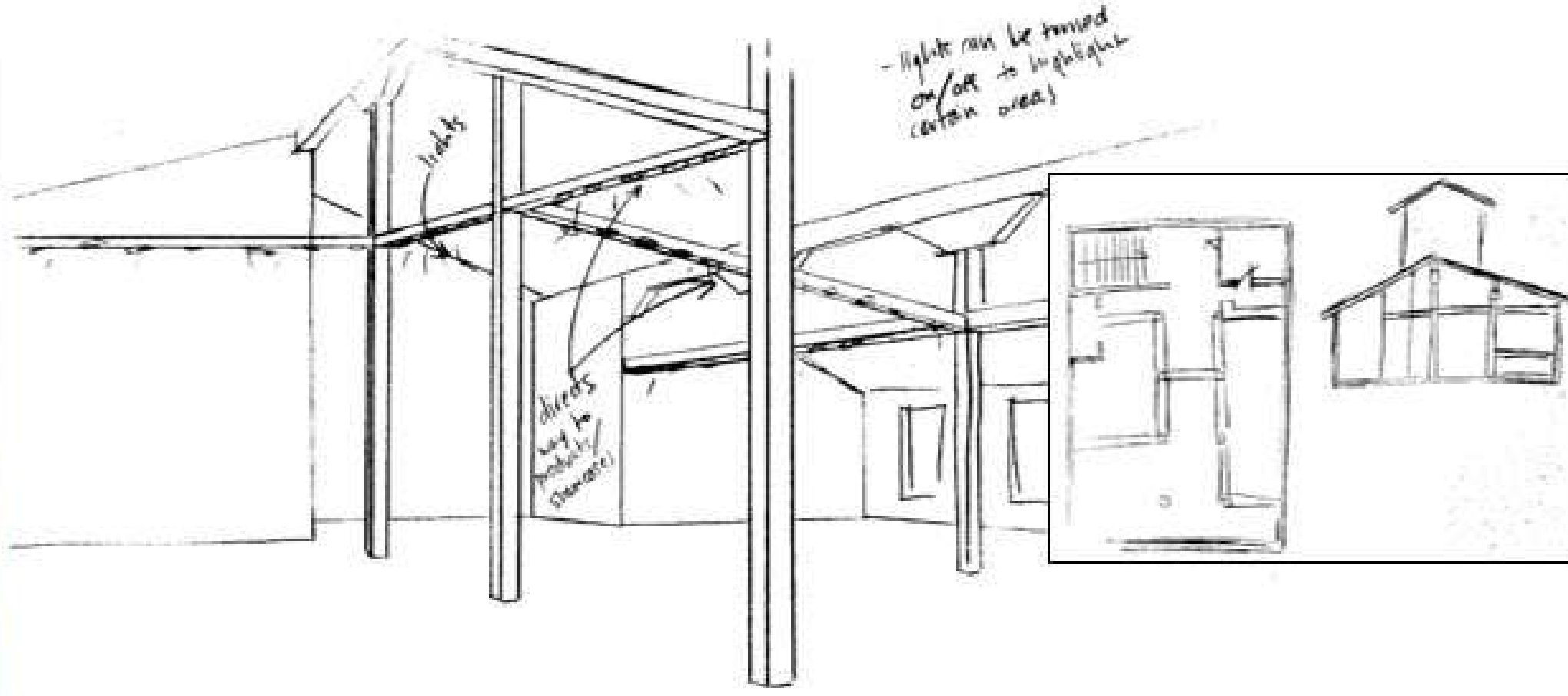
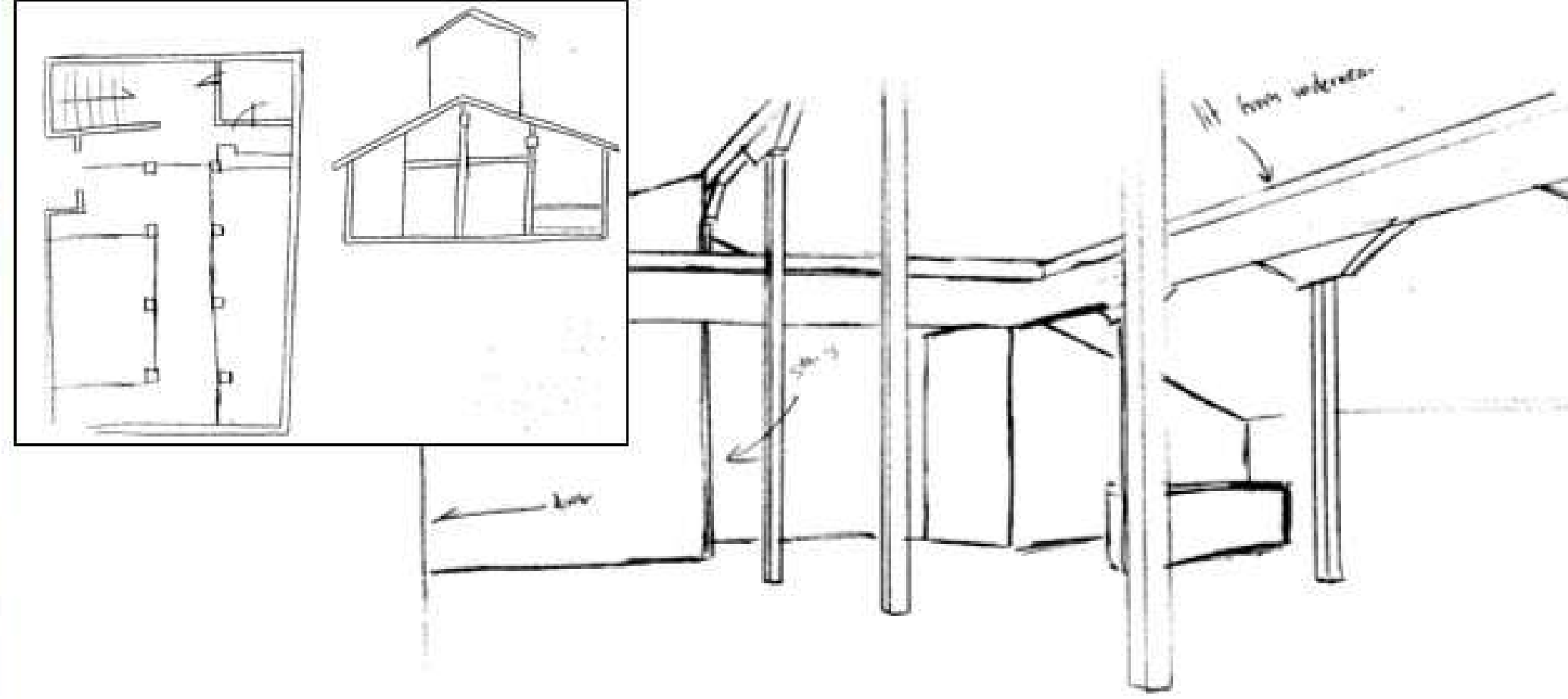

Julia Quayle

IDSN 2102 F19

ASSIGNMENT 9

Problem solving for staircase placement issues in the space.

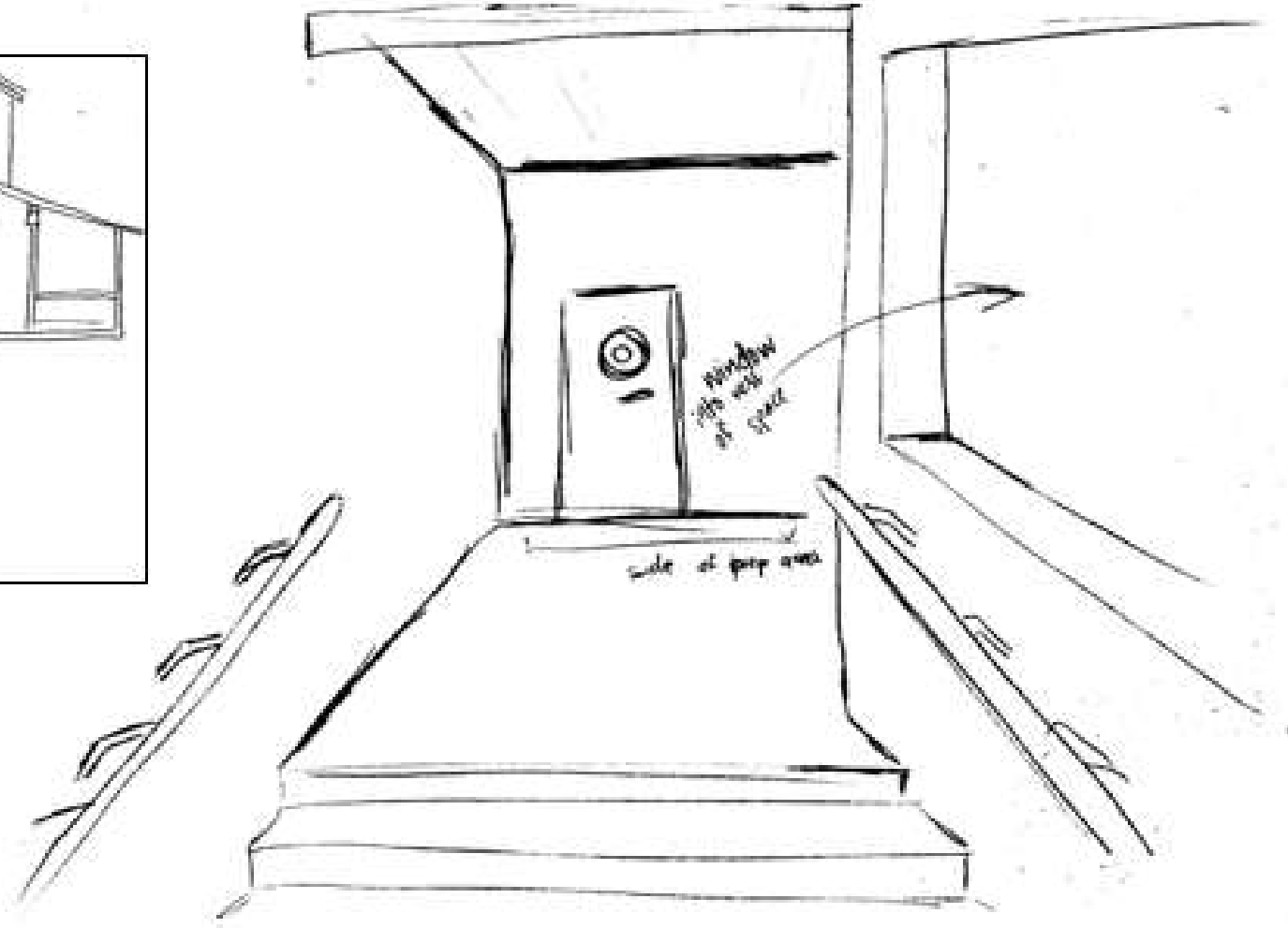
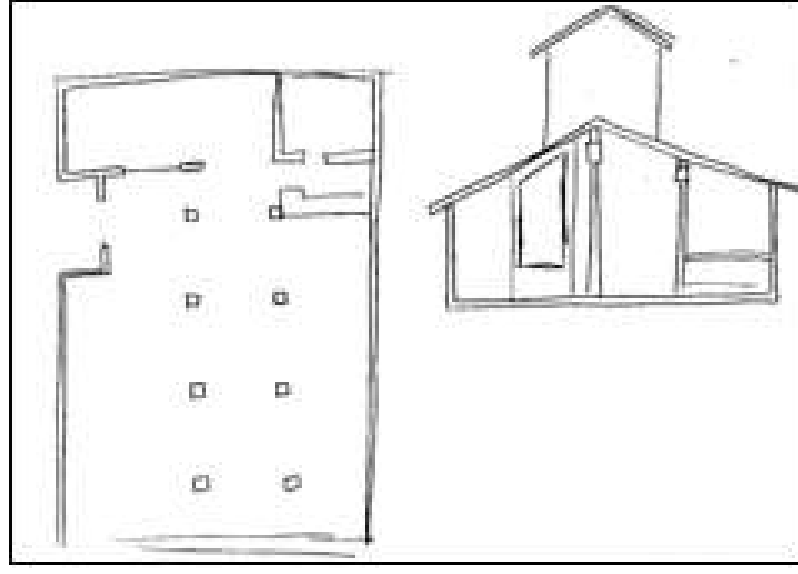
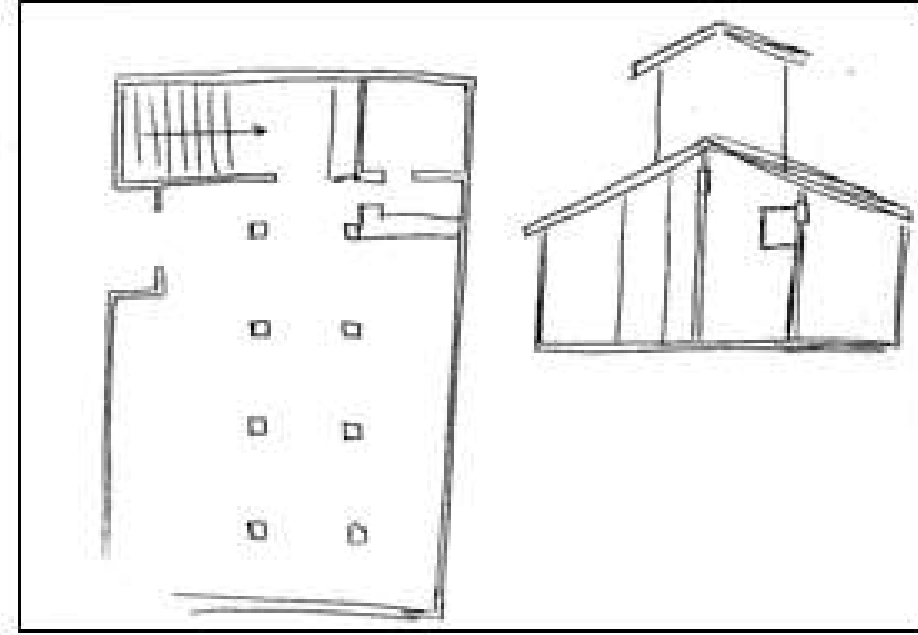
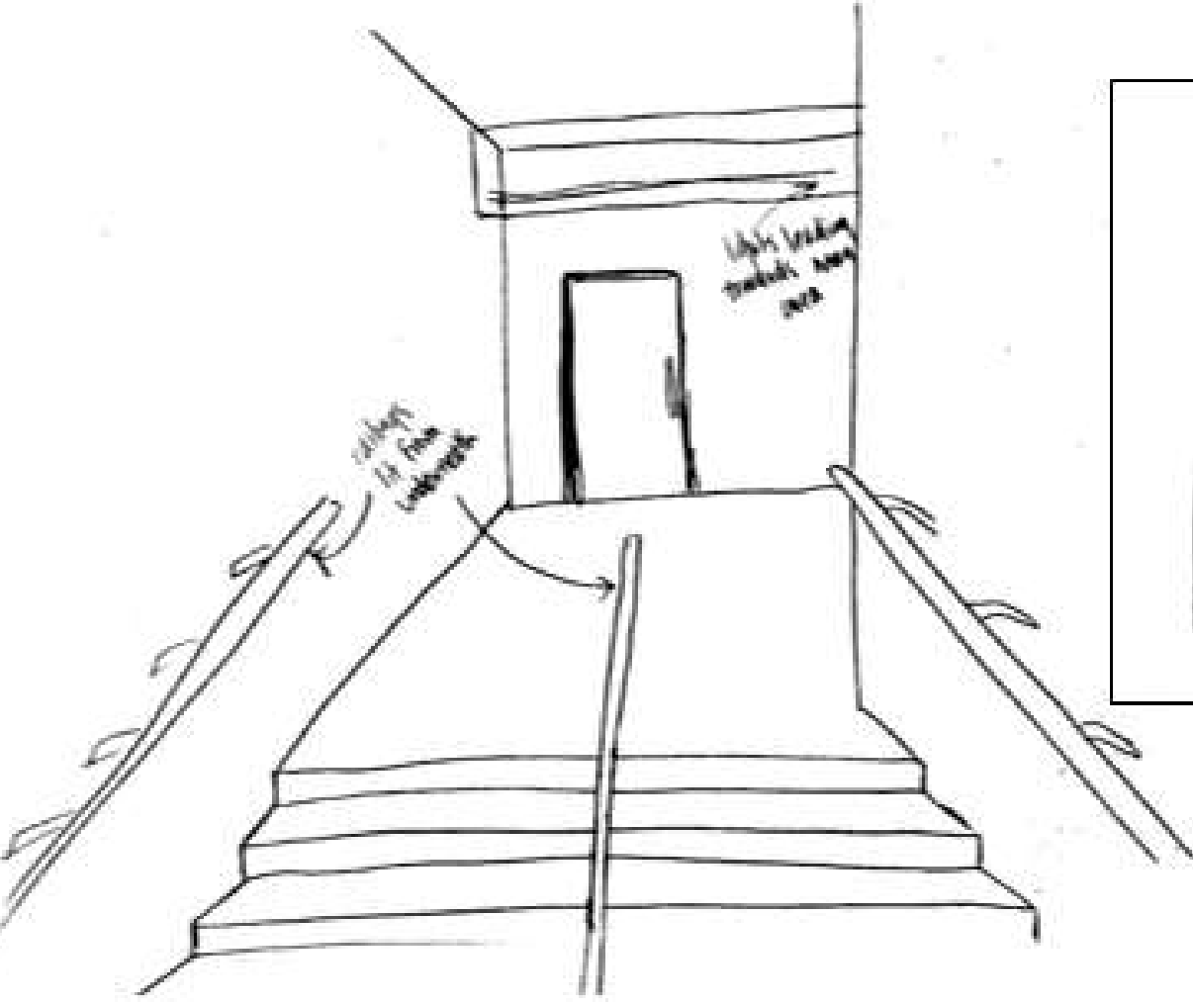

Julia Quayle

IDSN 2102 F19

ASSIGNMENT 9

Problem solving for ceiling/daylighting issues in the space.

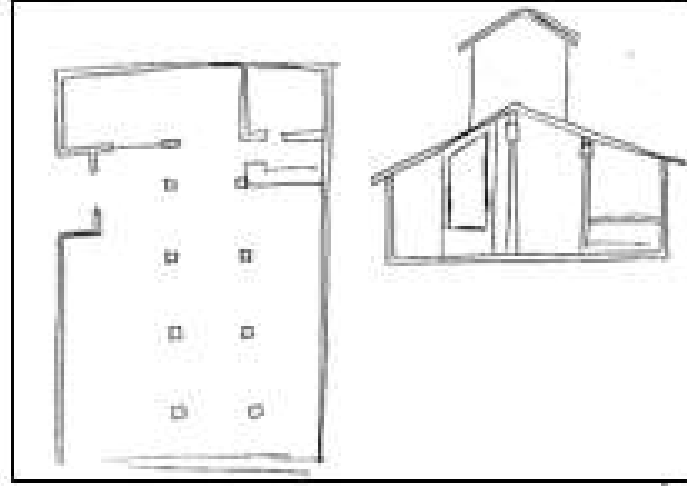

- evening events
- different colors

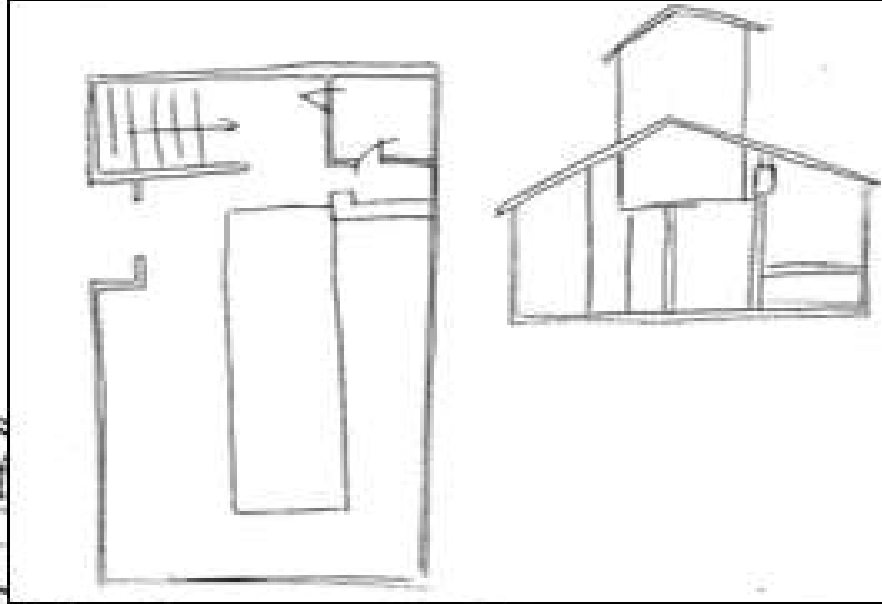
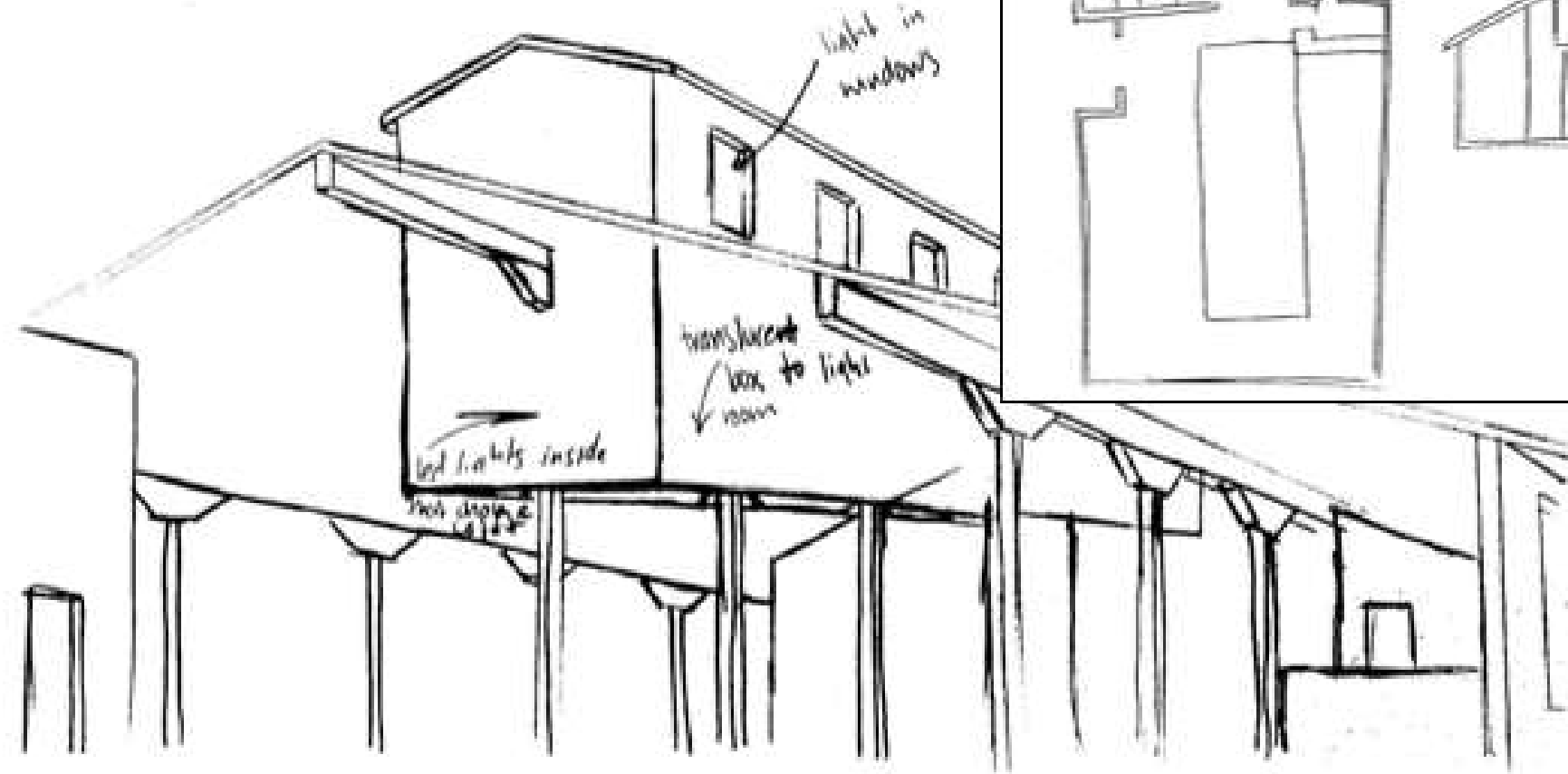
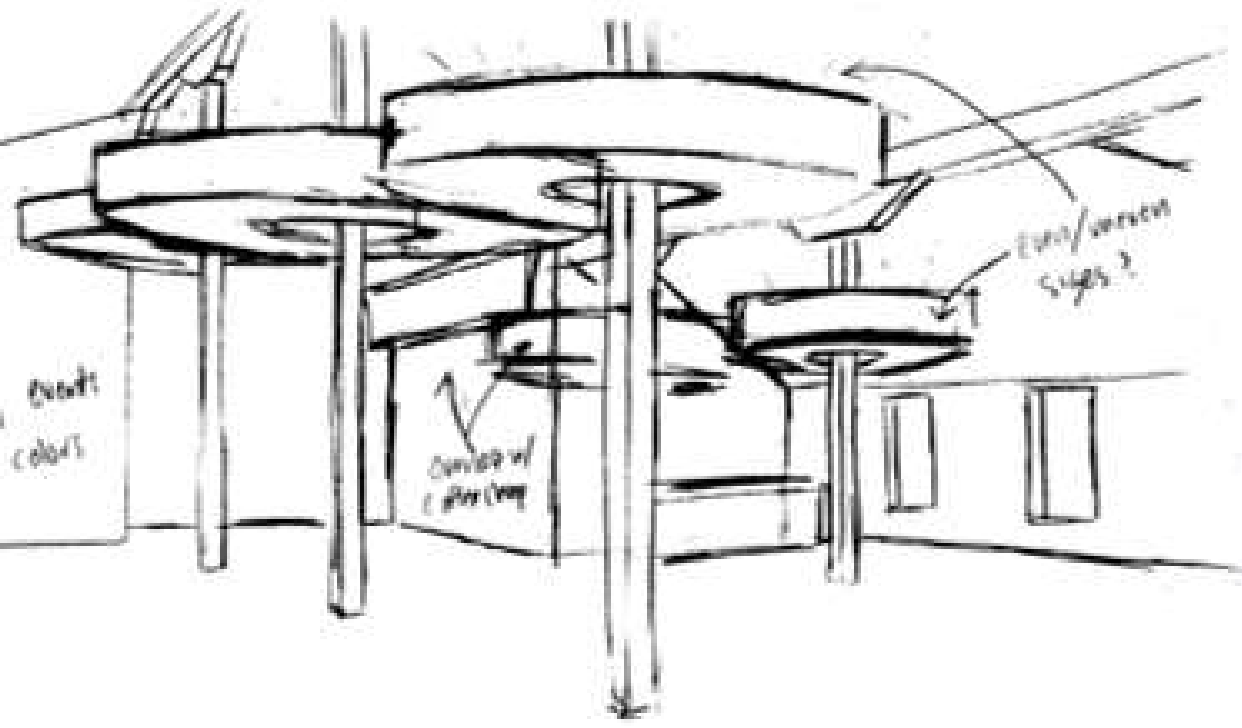

Julia Quayle

IDSN 2102 F19

ASSIGNMENT 9

Problem solving for back of house issues in the space.

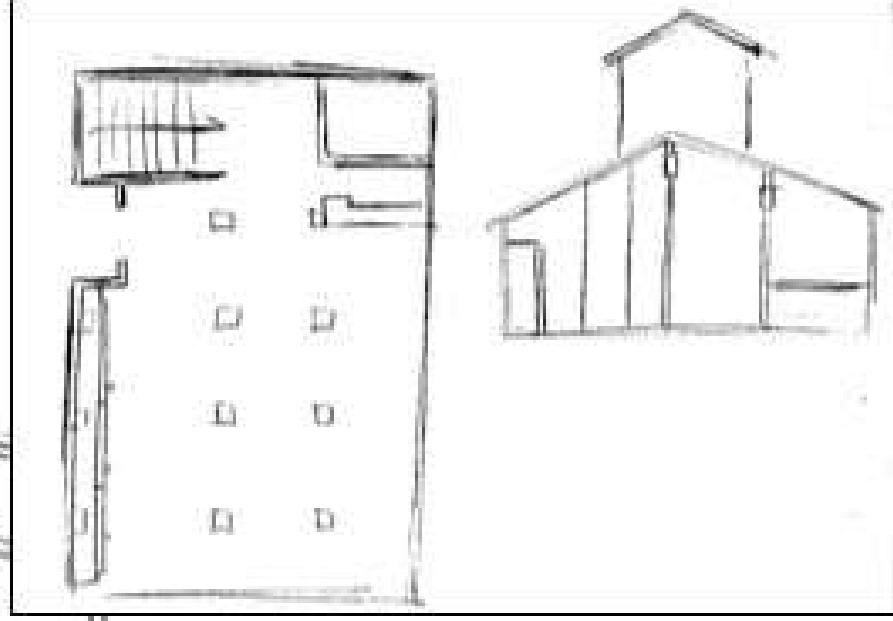
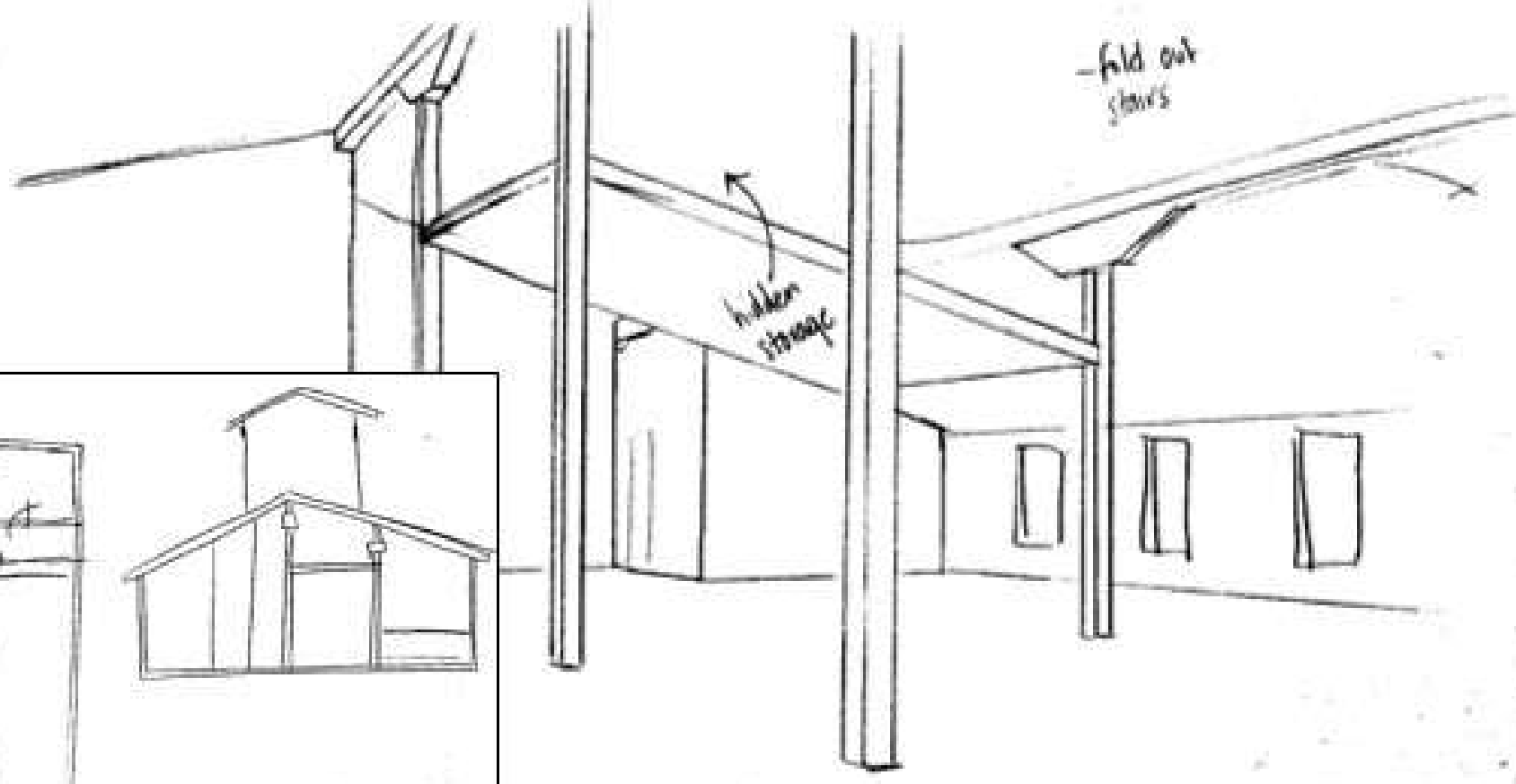
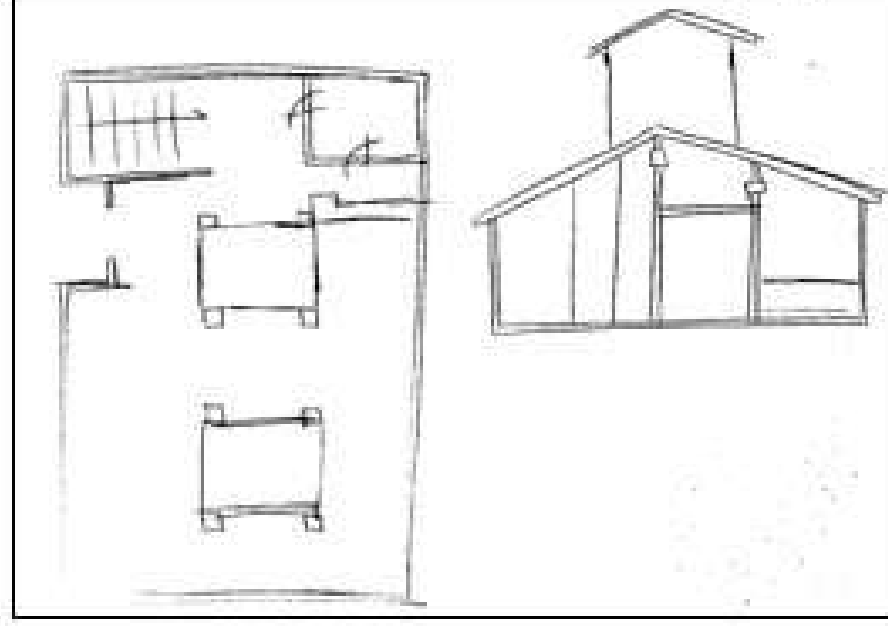

Julia Quayle

IDSN 2102 F19

ASSIGNMENT 10

Preliminary
furniture plan
#1

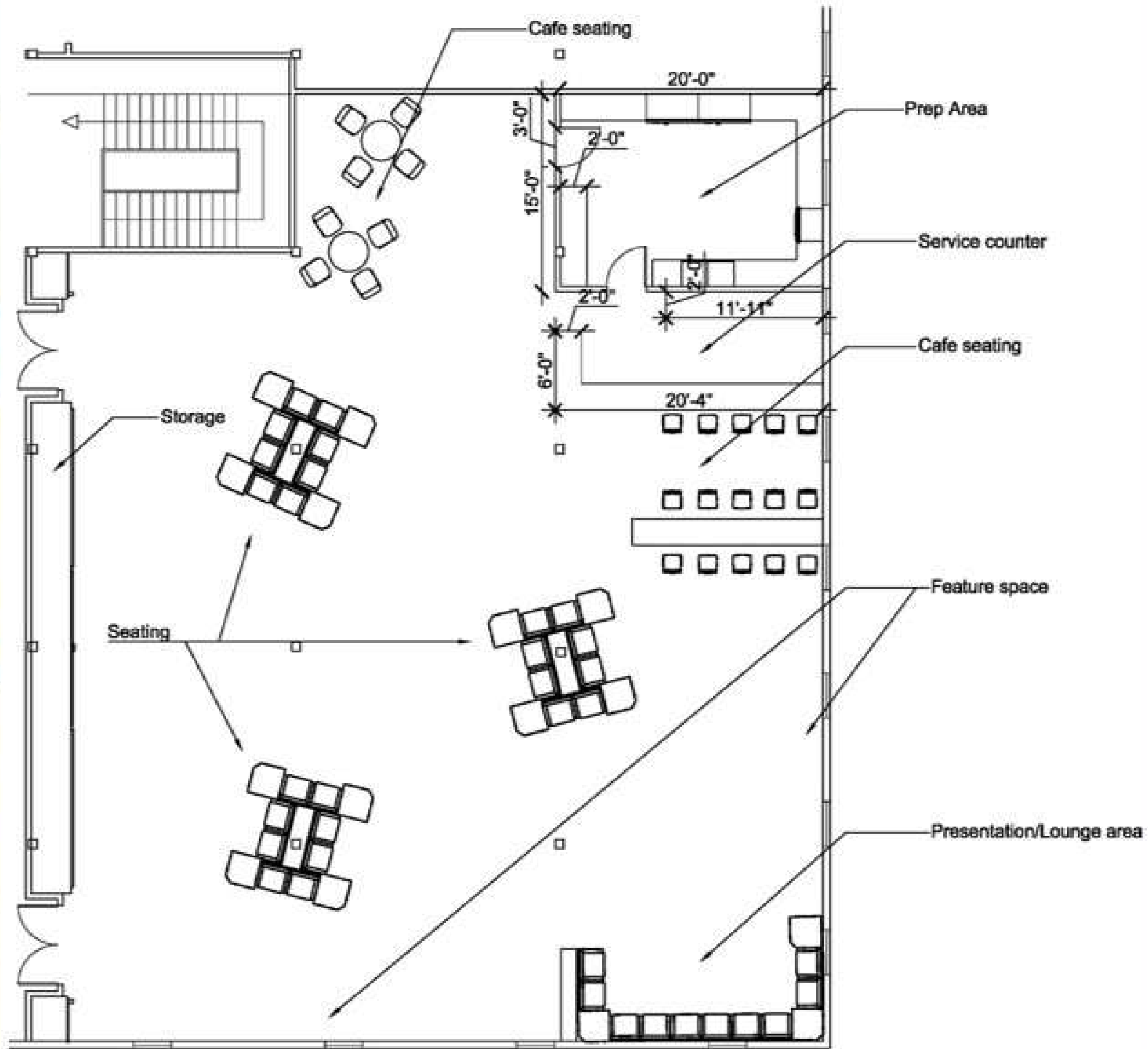

Julia Quayle

IDSN 2102 F19

ASSIGNMENT 10

Preliminary furniture plan #2

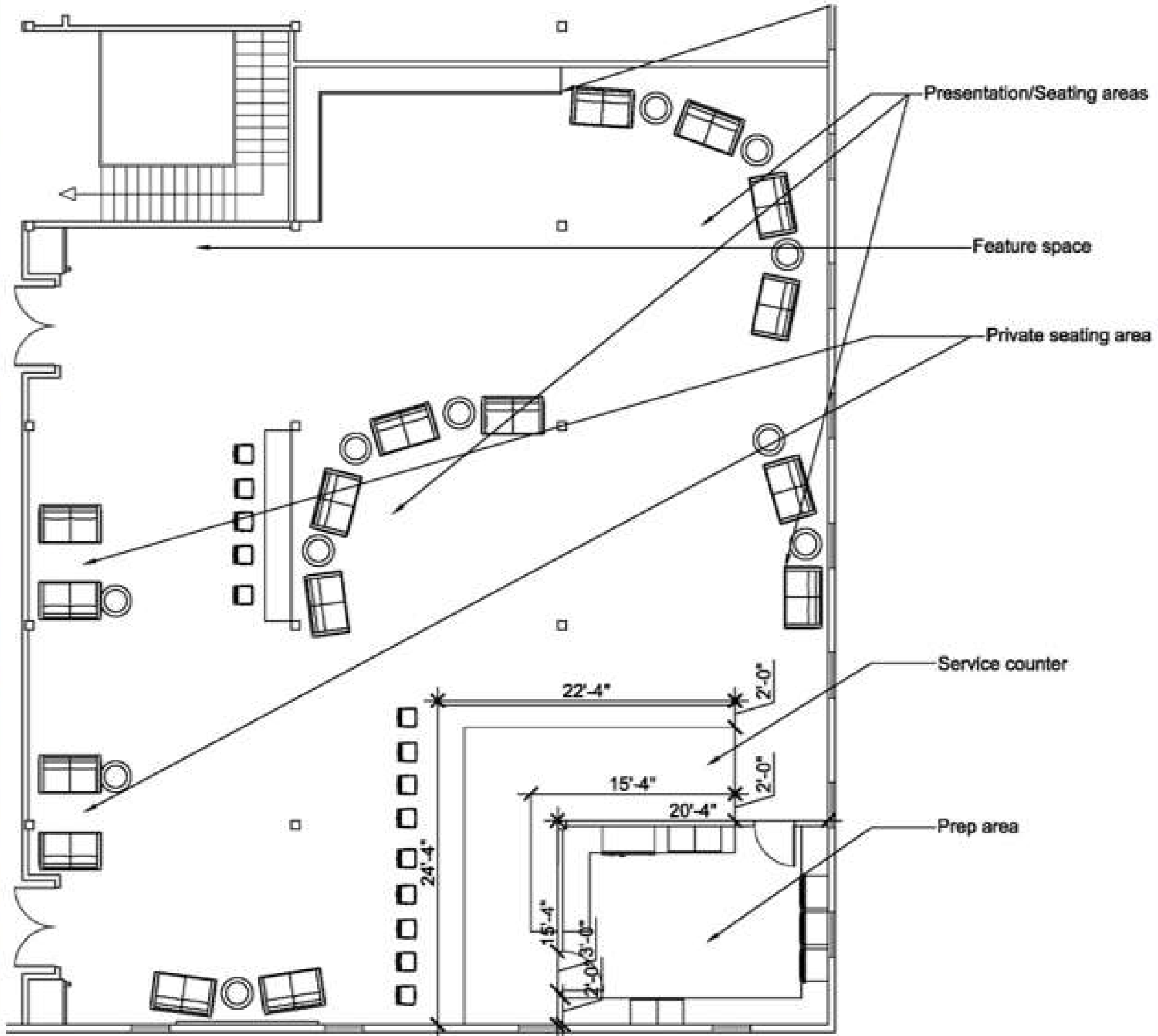

Julia Quayle

IDSN 2102 F19

ASSIGNMENT 10

Preliminary
furniture plan
#3

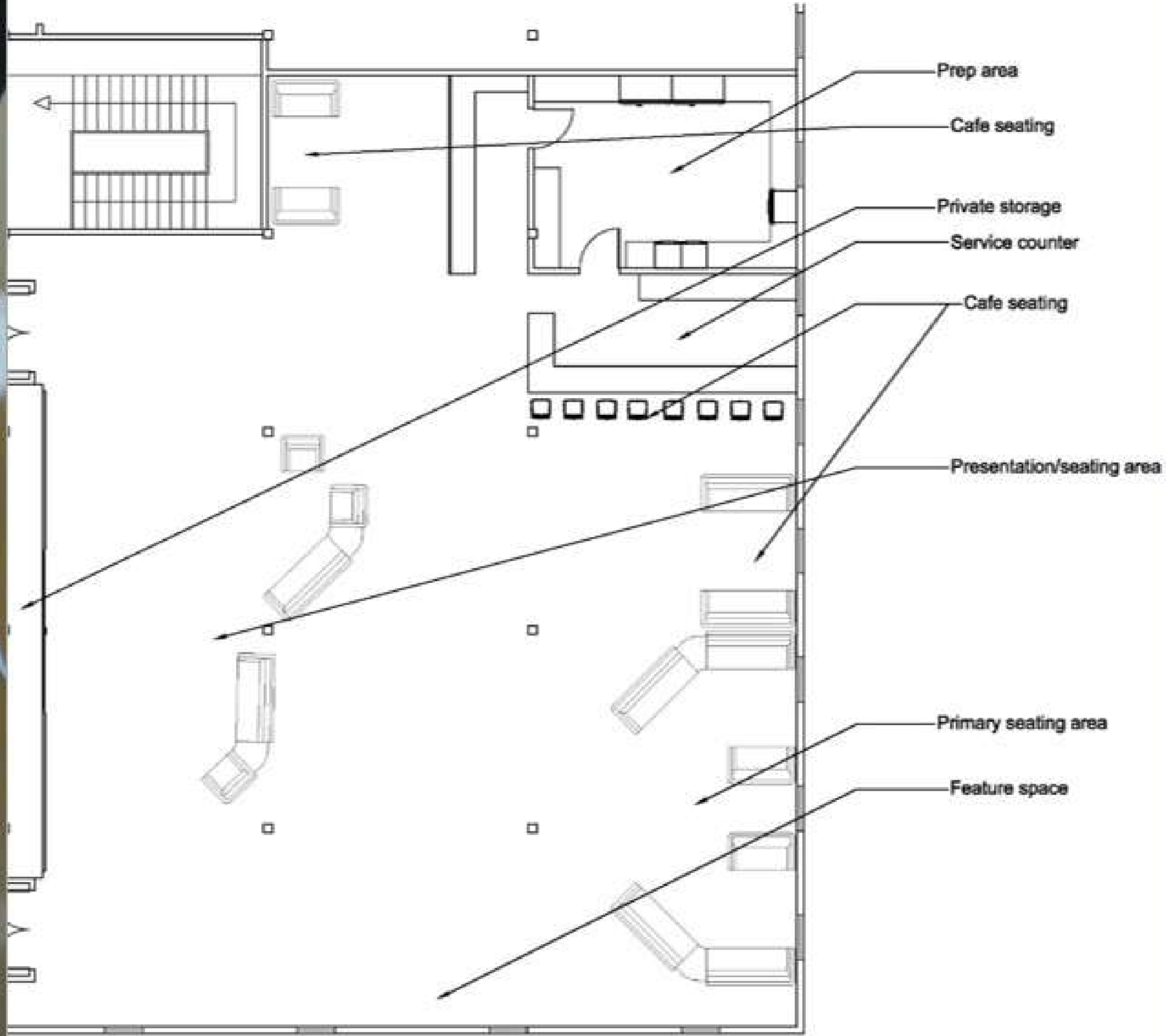

Julia Quayle

IDSN 2102 F19

ASSIGNMENT 11

Section and plans for scissor staircase.

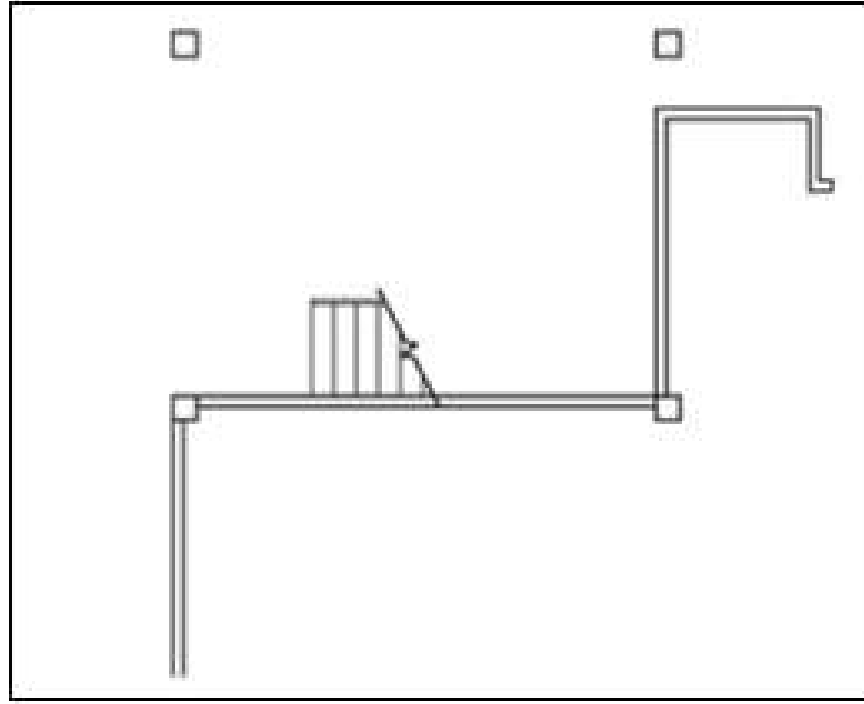

Floorplan for 1st floor

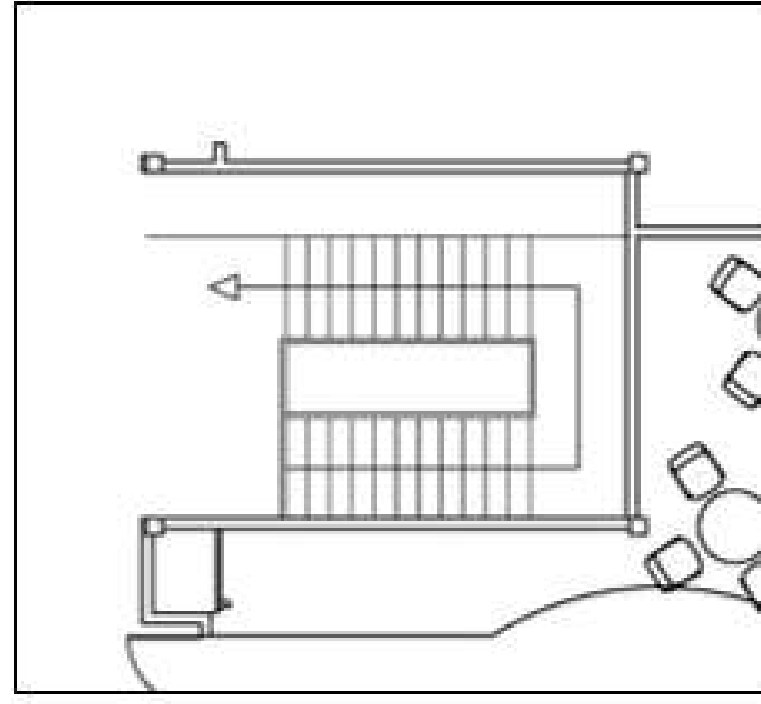

Floorplan for 2nd floor

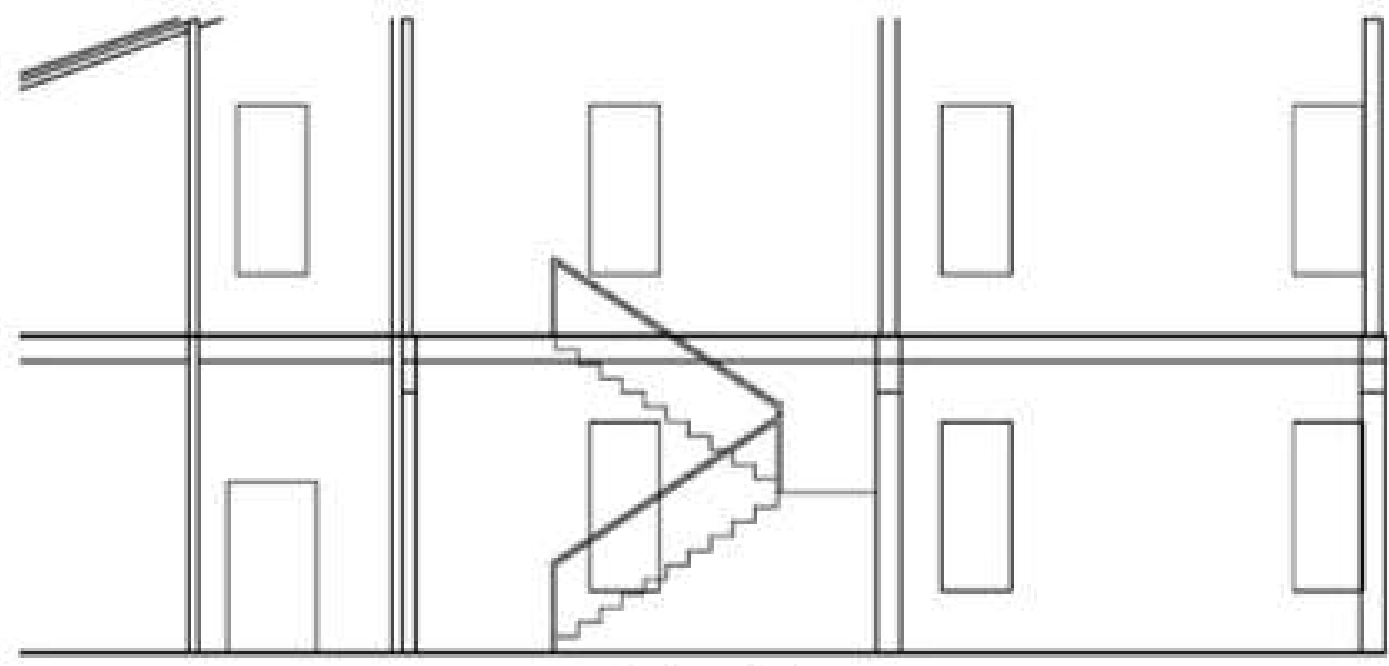

Section view

Julia Quayle

IDSN 2102 F19

ASSIGNMENT 11

Section and plans for an L-shaped staircase.

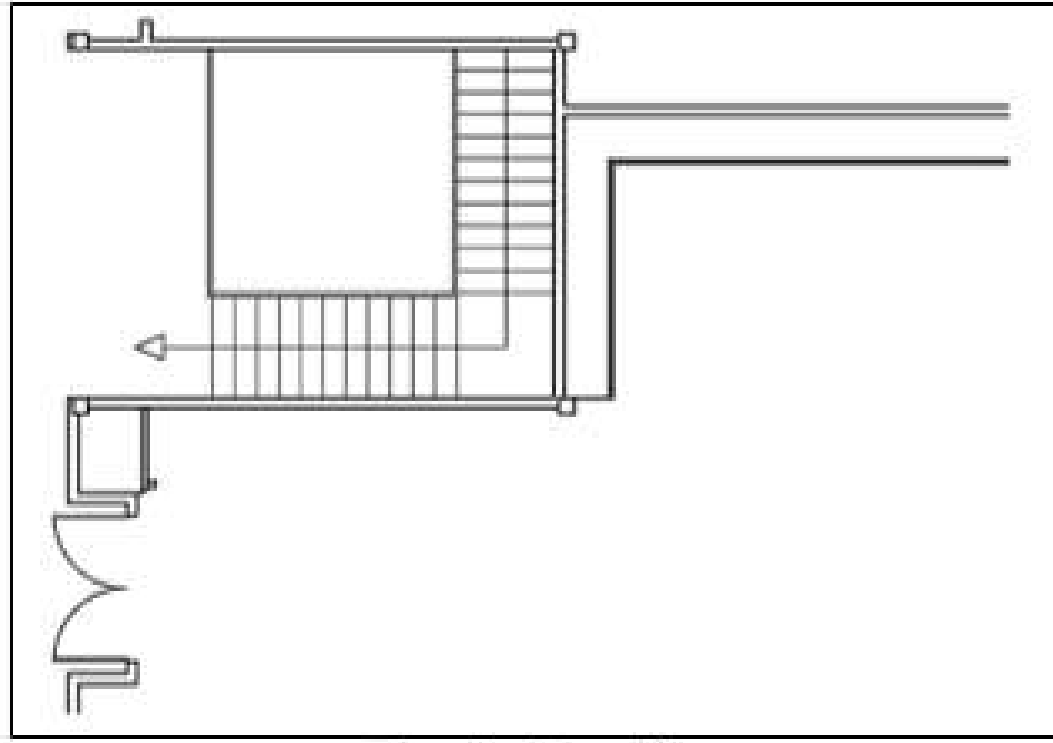

Floorplan for 1st floor

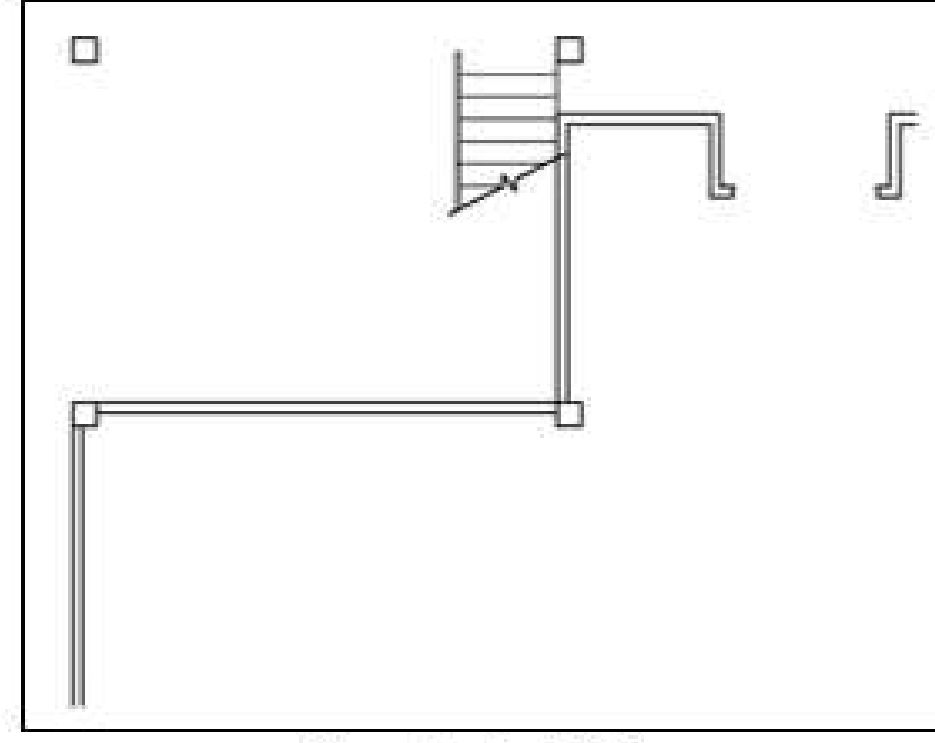

Floorplan for 2nd floor

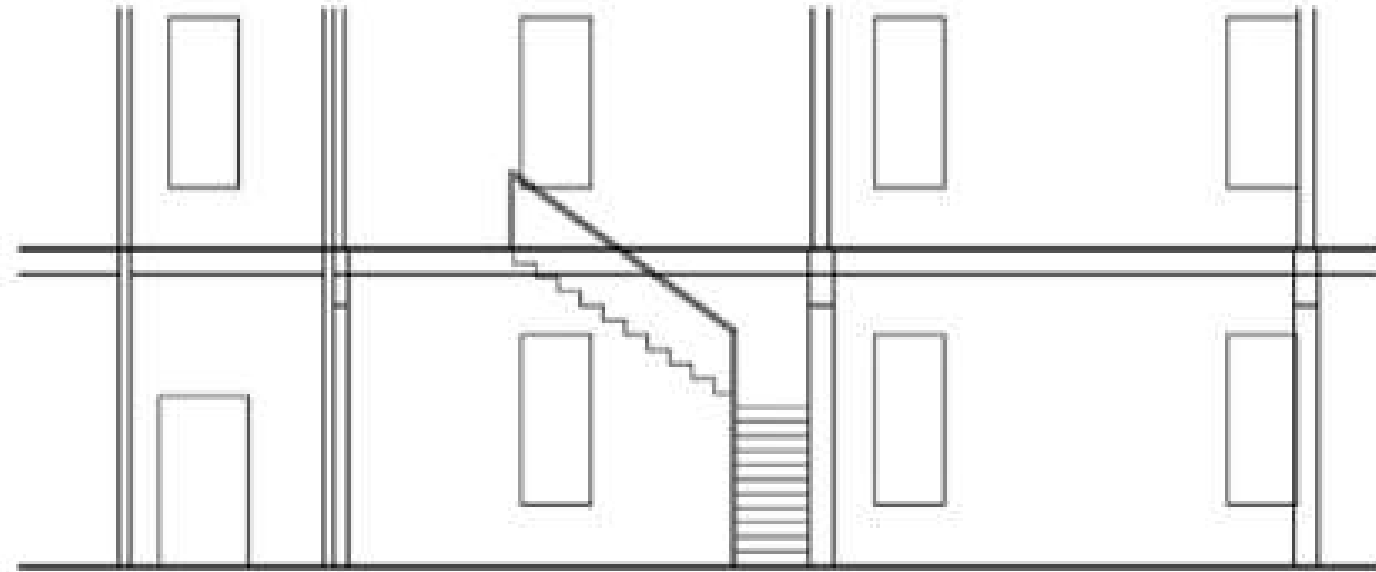

Section view

Julia Quayle

IDSN 2102 F19