

Portfolio 1



Carrie Thompson

IDSN 2101 F19

Assignment 1: Quick Sketch
Competencies-
Architectural & Engineering
Scales

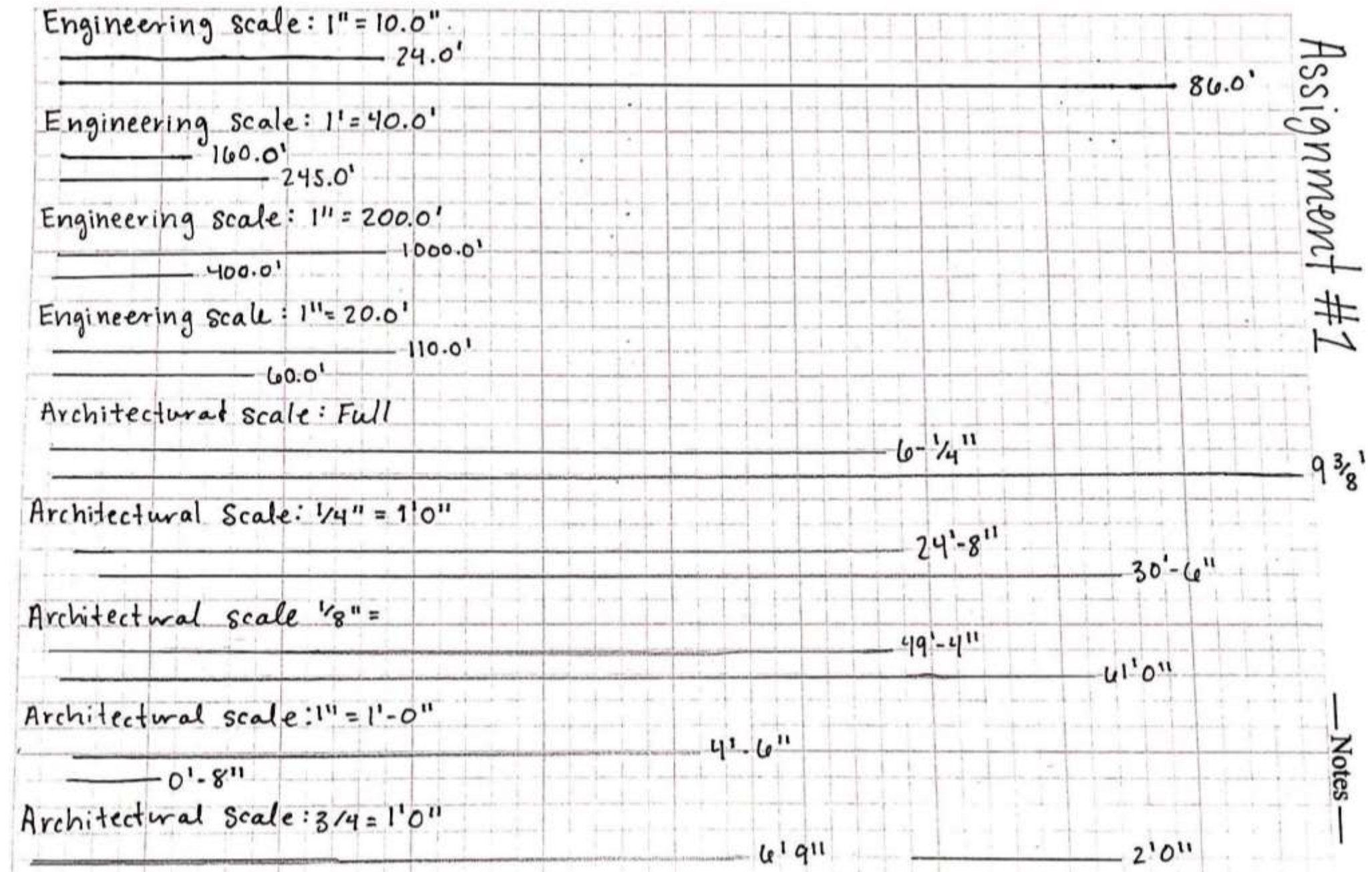

Carrie Thompson

IDSN 2102 F19

**Assignment 2A: Quick
Sketch Competencies-
Orthographic
Projection**

Carrie Thompson

IDSN 2102 F19

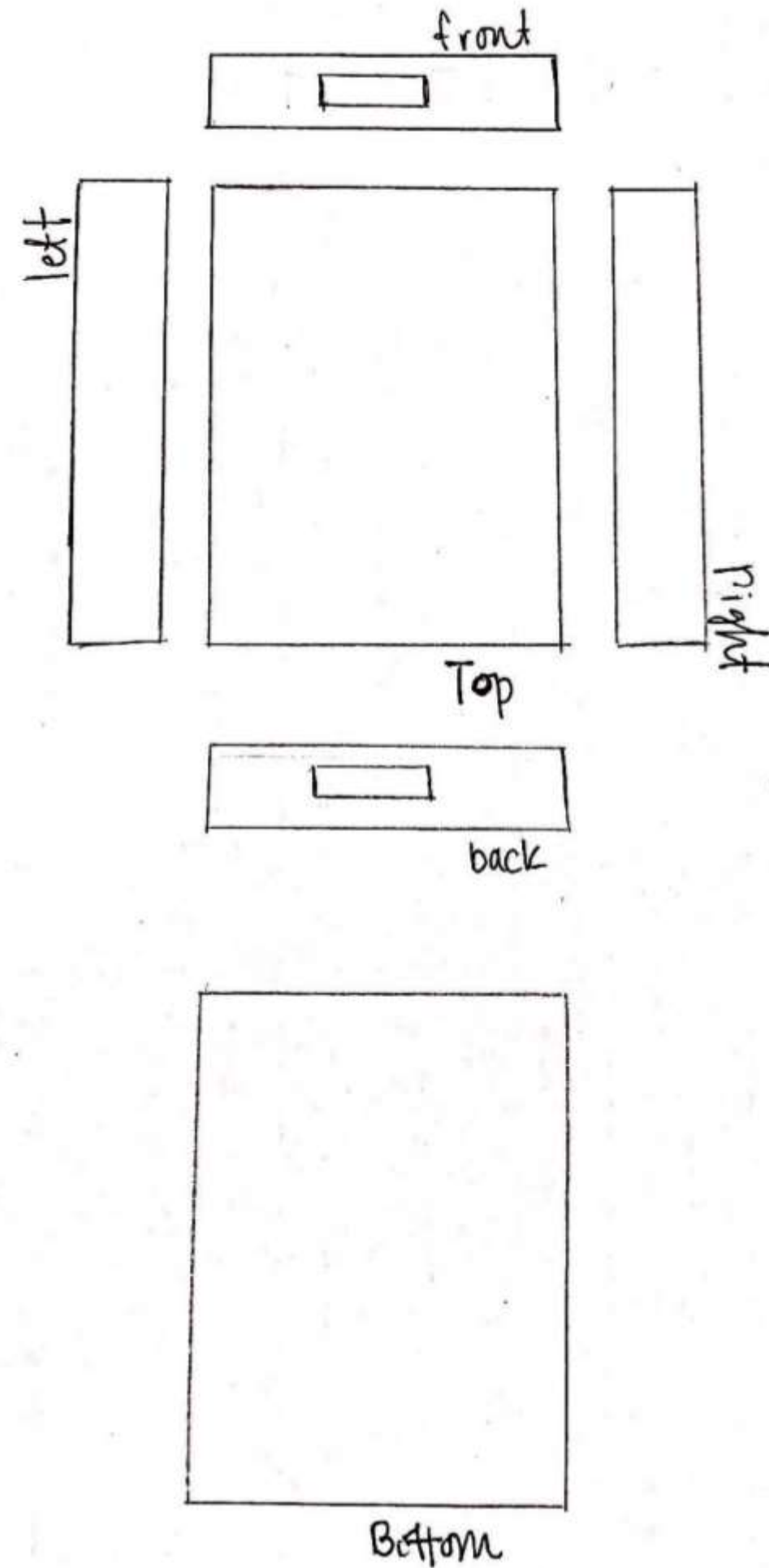

**Assignment 2B: Quick
Sketch Competencies-
Isometric Projection**

Carrie Thompson

IDSN 2102 F19

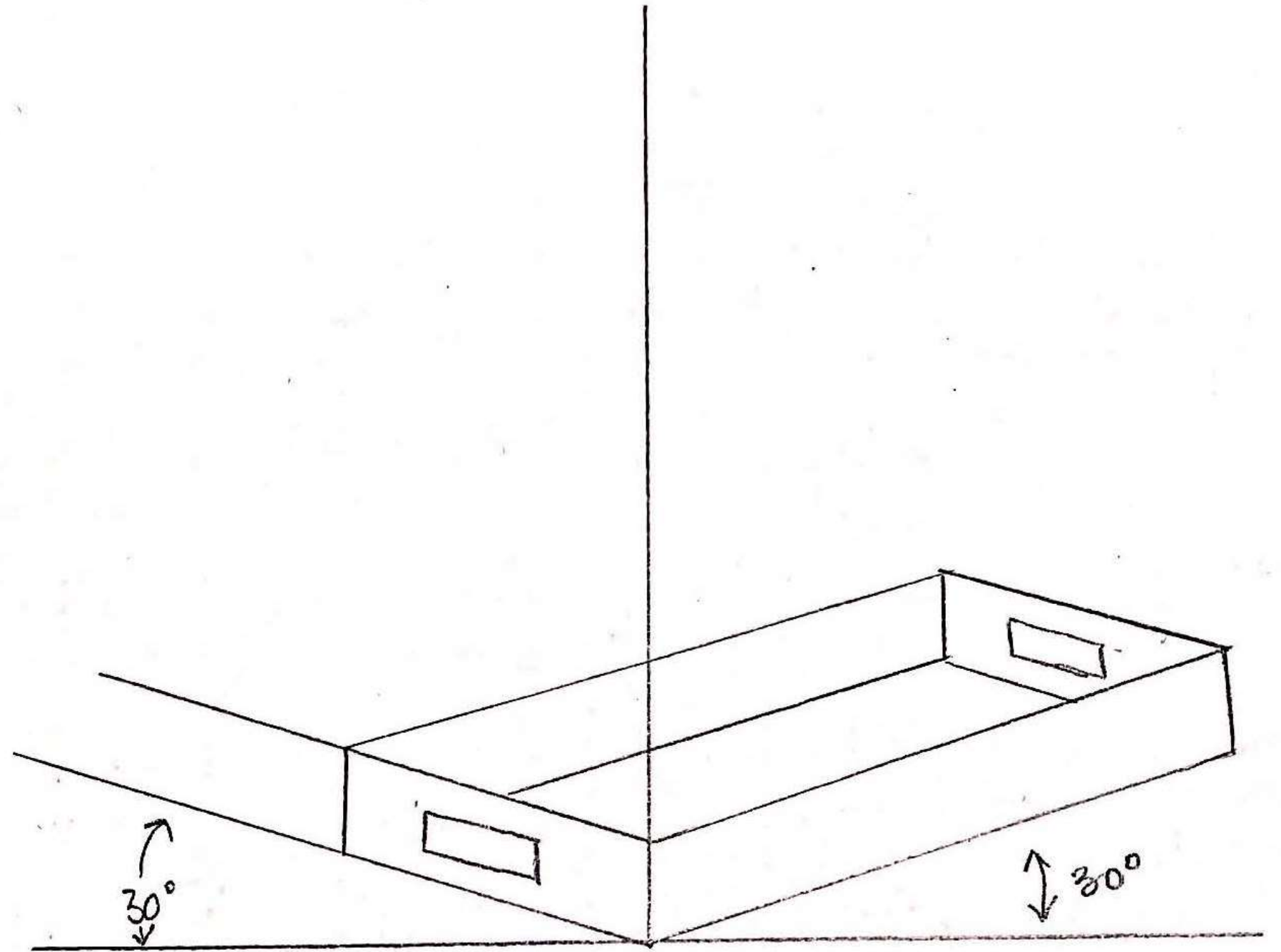

**Assignment 2C: Quick
Sketch Competencies-
Oblique Drawings**

Carrie Thompson

IDSN 2102 F19

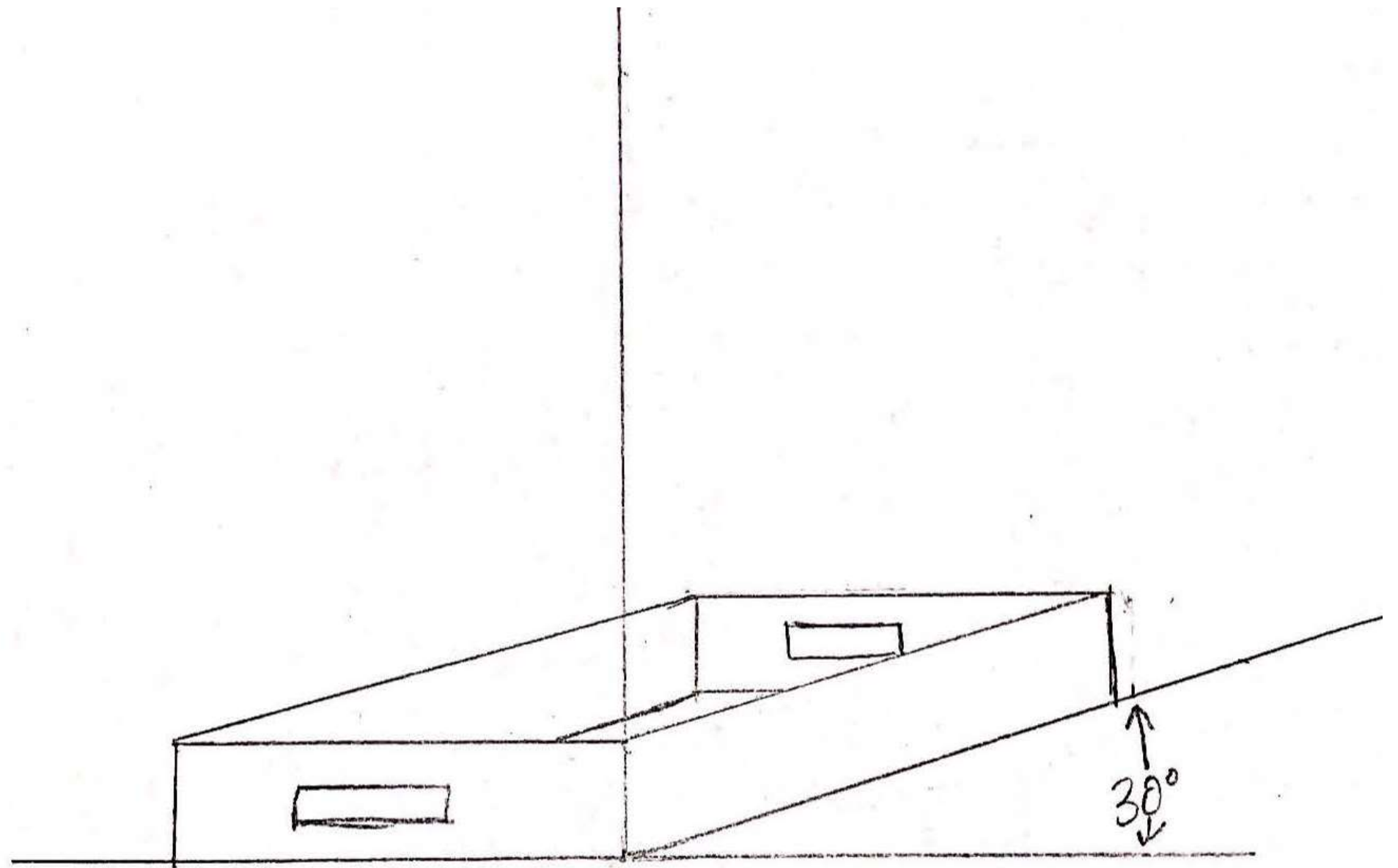

**Assignment 2D: Quick
Sketch Competencies-
Perspective Drawings**

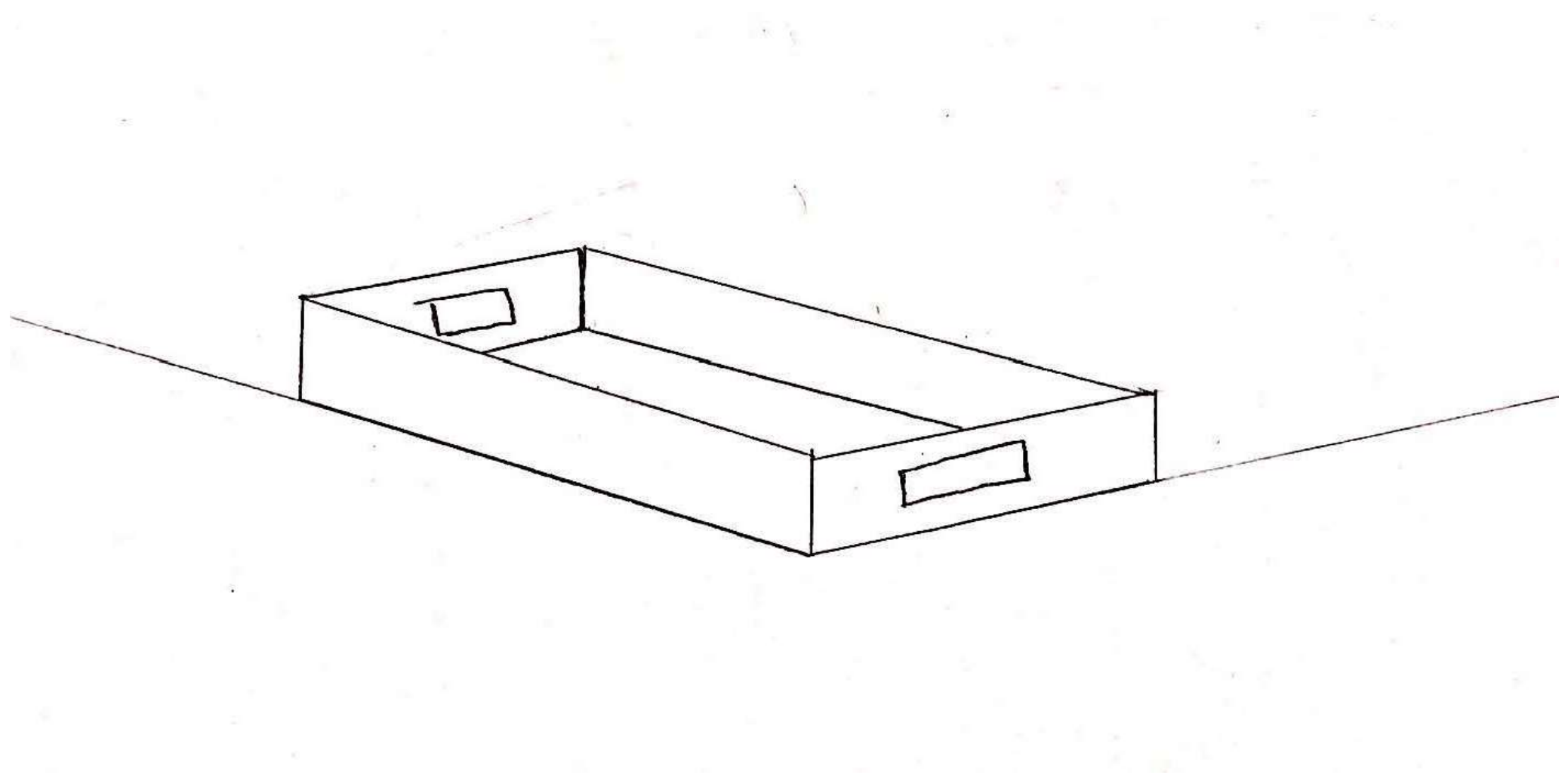

Carrie Thompson

IDSN 2102 F19

**Assignment 3A: Activity
Space Studies**



Carrie Thompson
IDSN 2102 F19

Assignment 3A:
Activity Space Studies

Carrie Thompson
IDSN 2102 F19

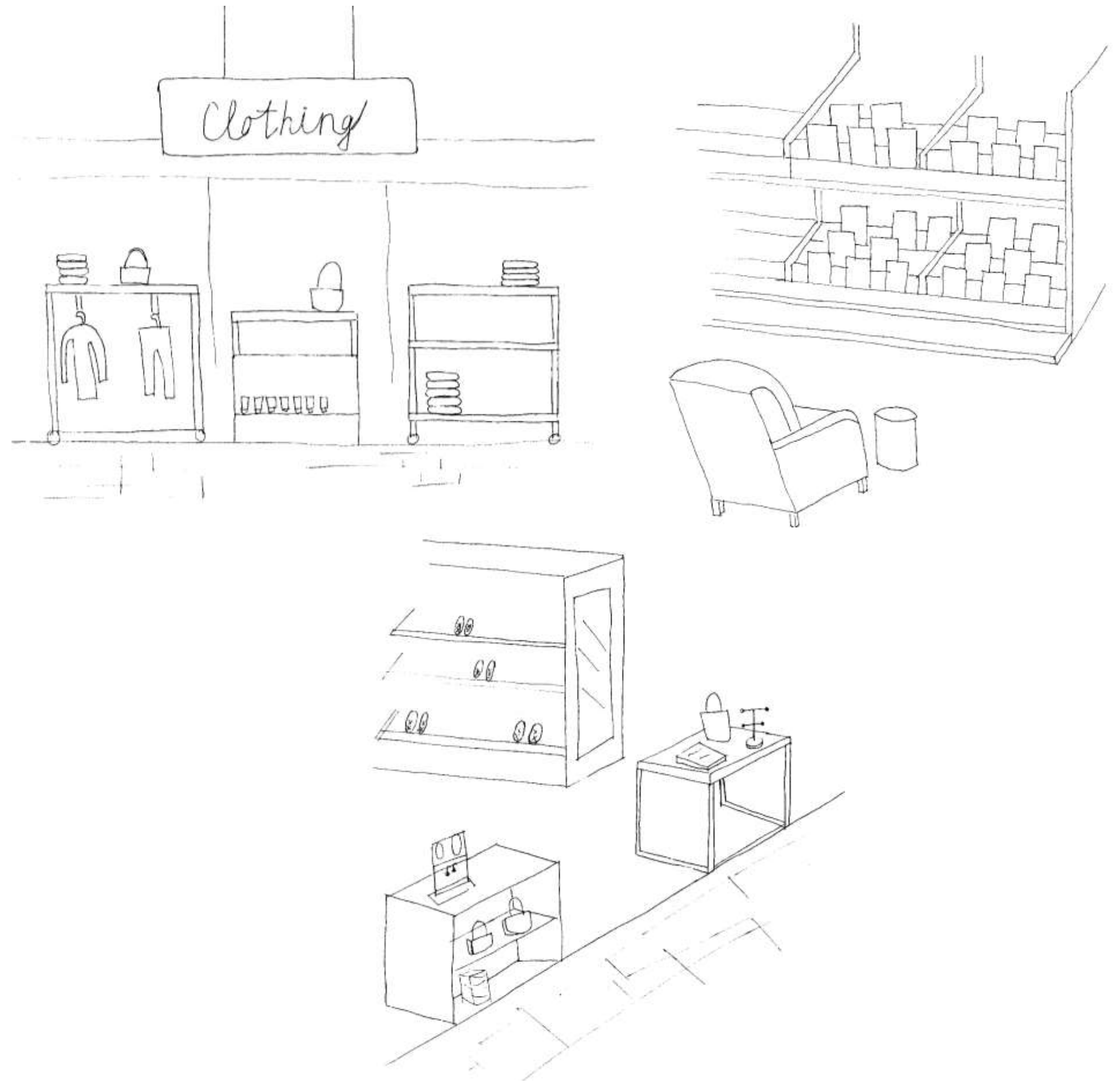

Assignment 3B: Activity
Space Studies- Shopping
alone in a boutique

Carrie Thompson
IDSN 2102 F19

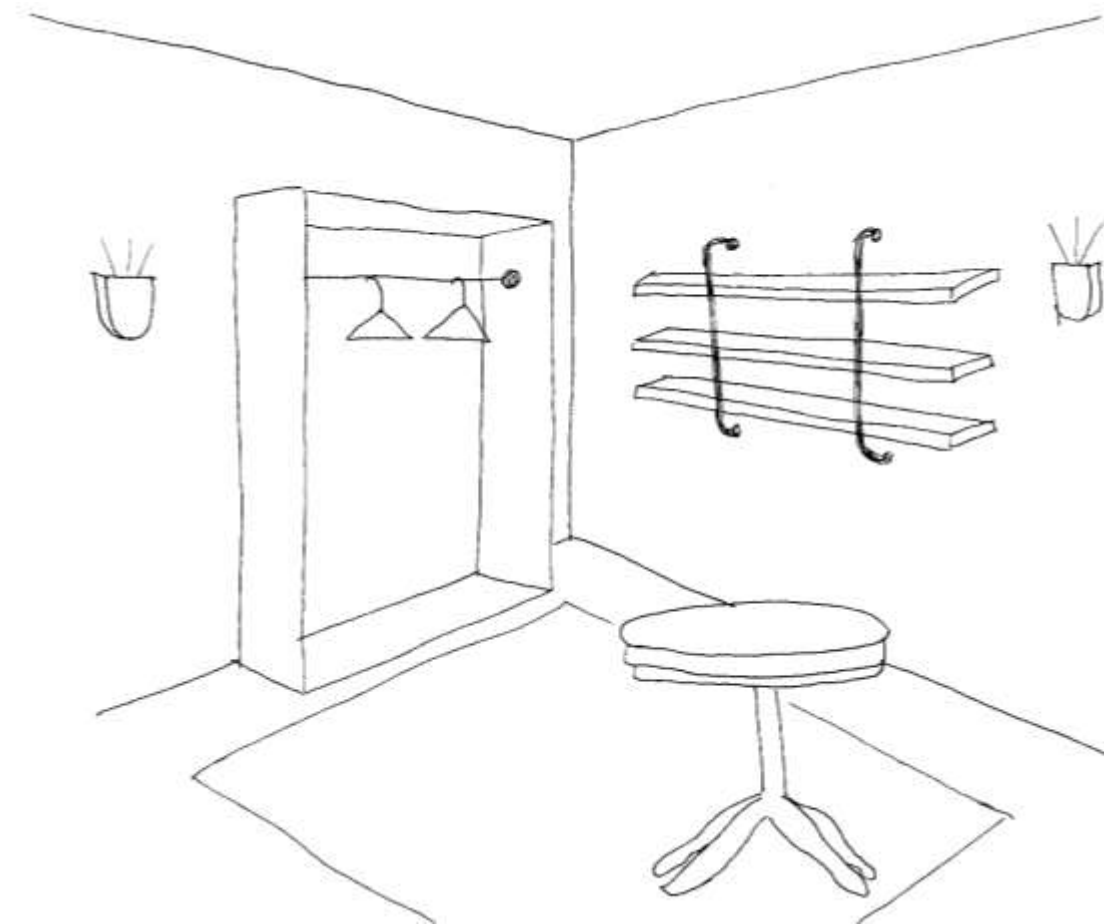
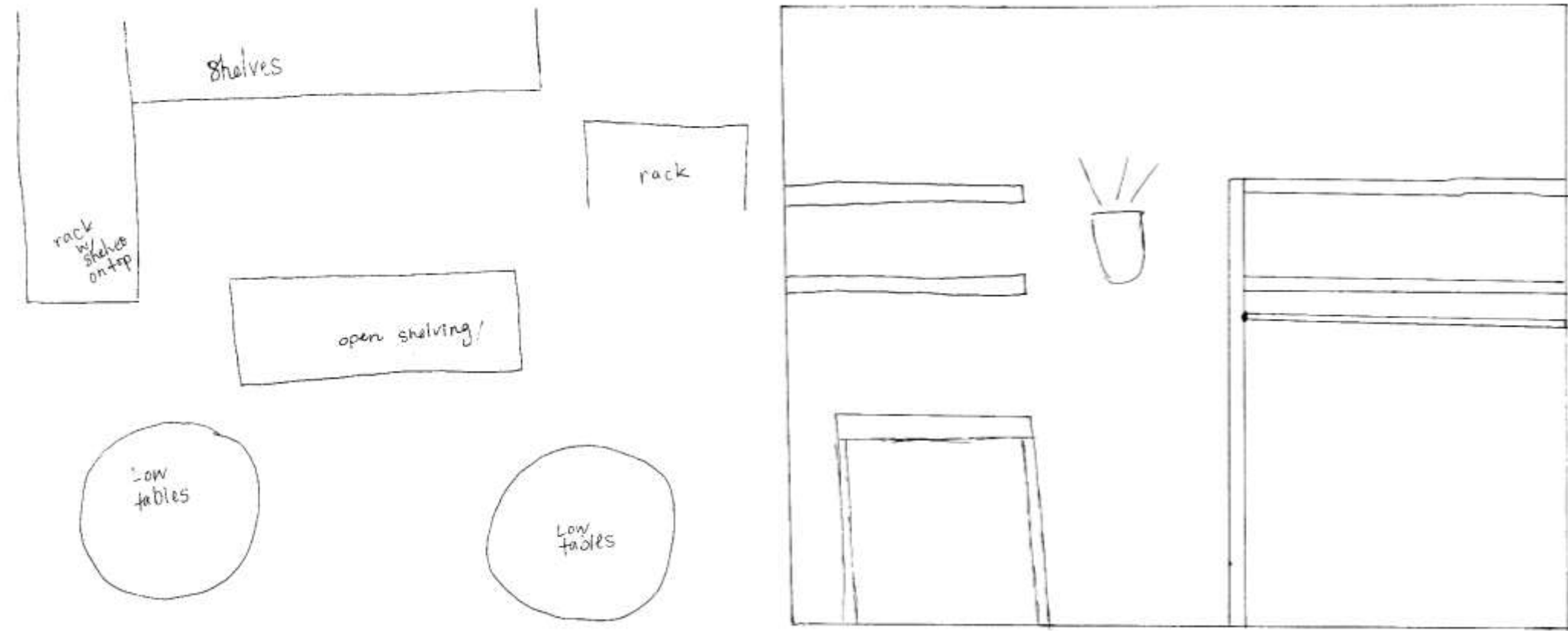

Assignment 3B:

Activity Space Studies-
Having coffee or snack
while shopping in a
boutique

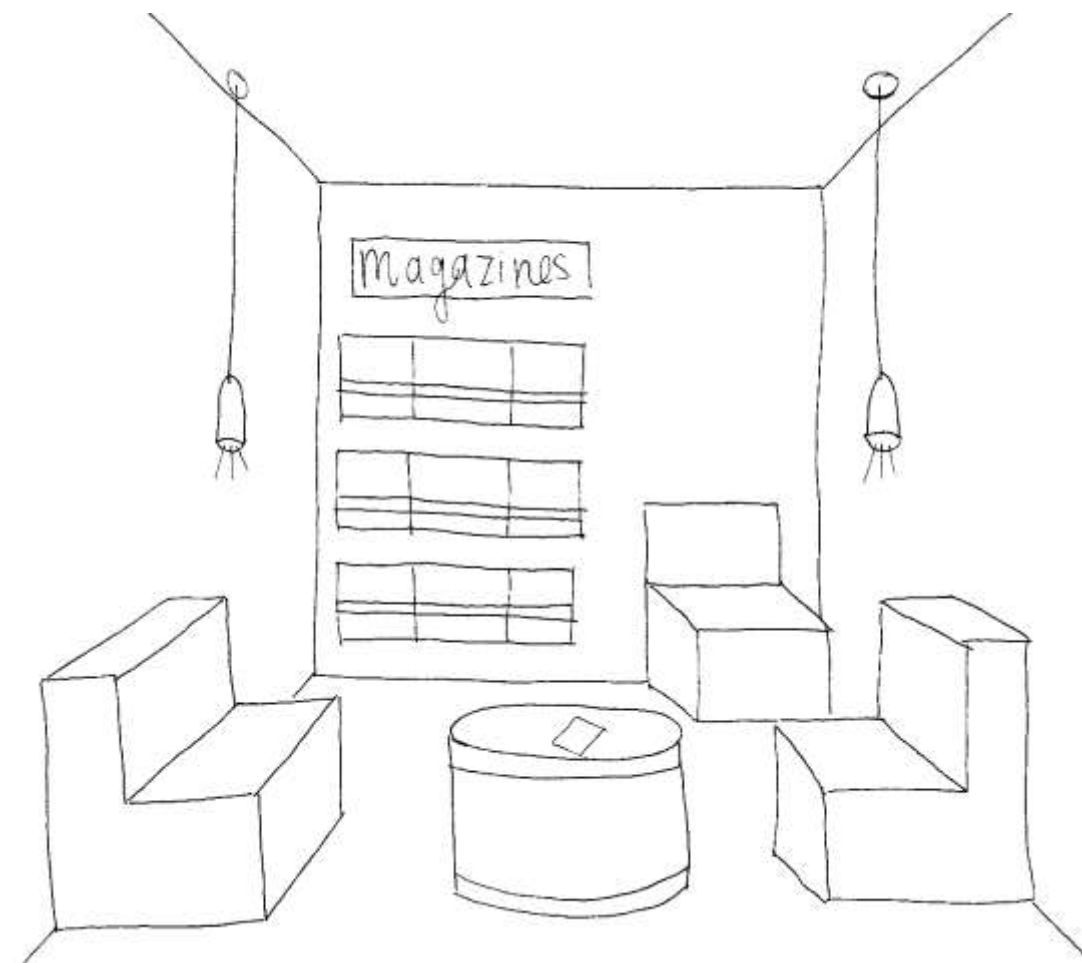
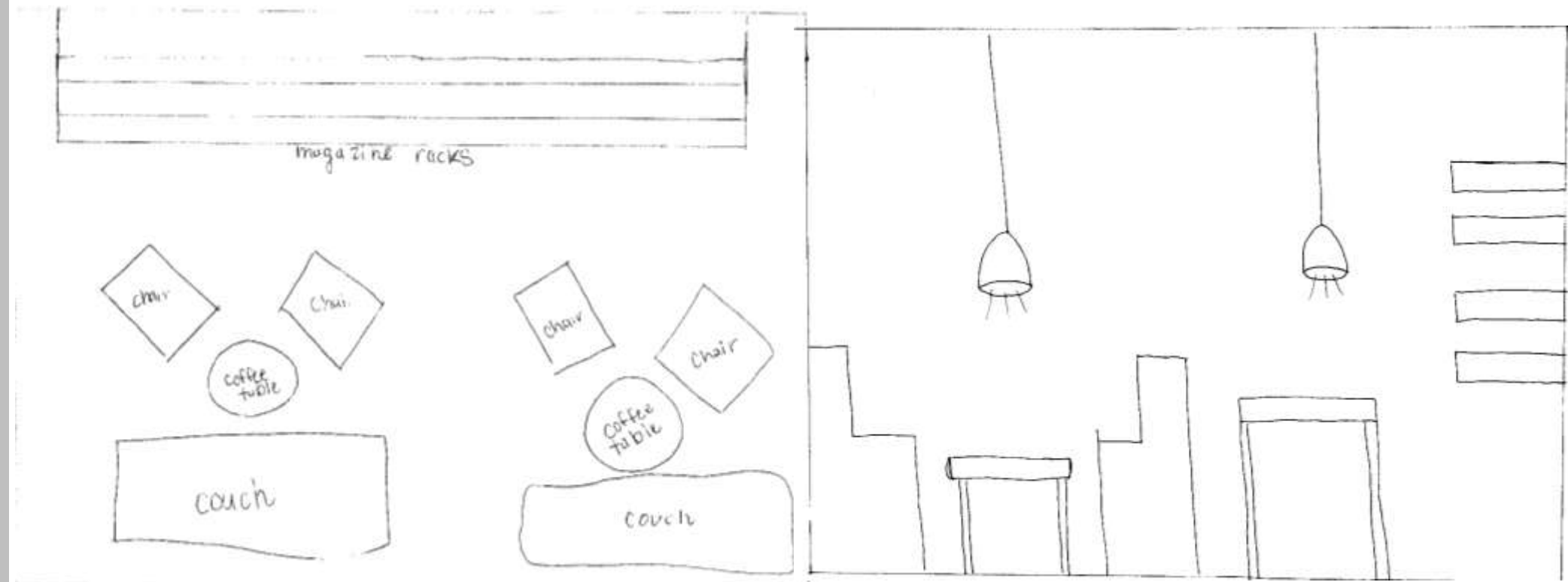

Carrie Thompson

IDSN 2102 F19

Assignment 3B:
Activity Space Studies-
Shopping with friends
in a boutique

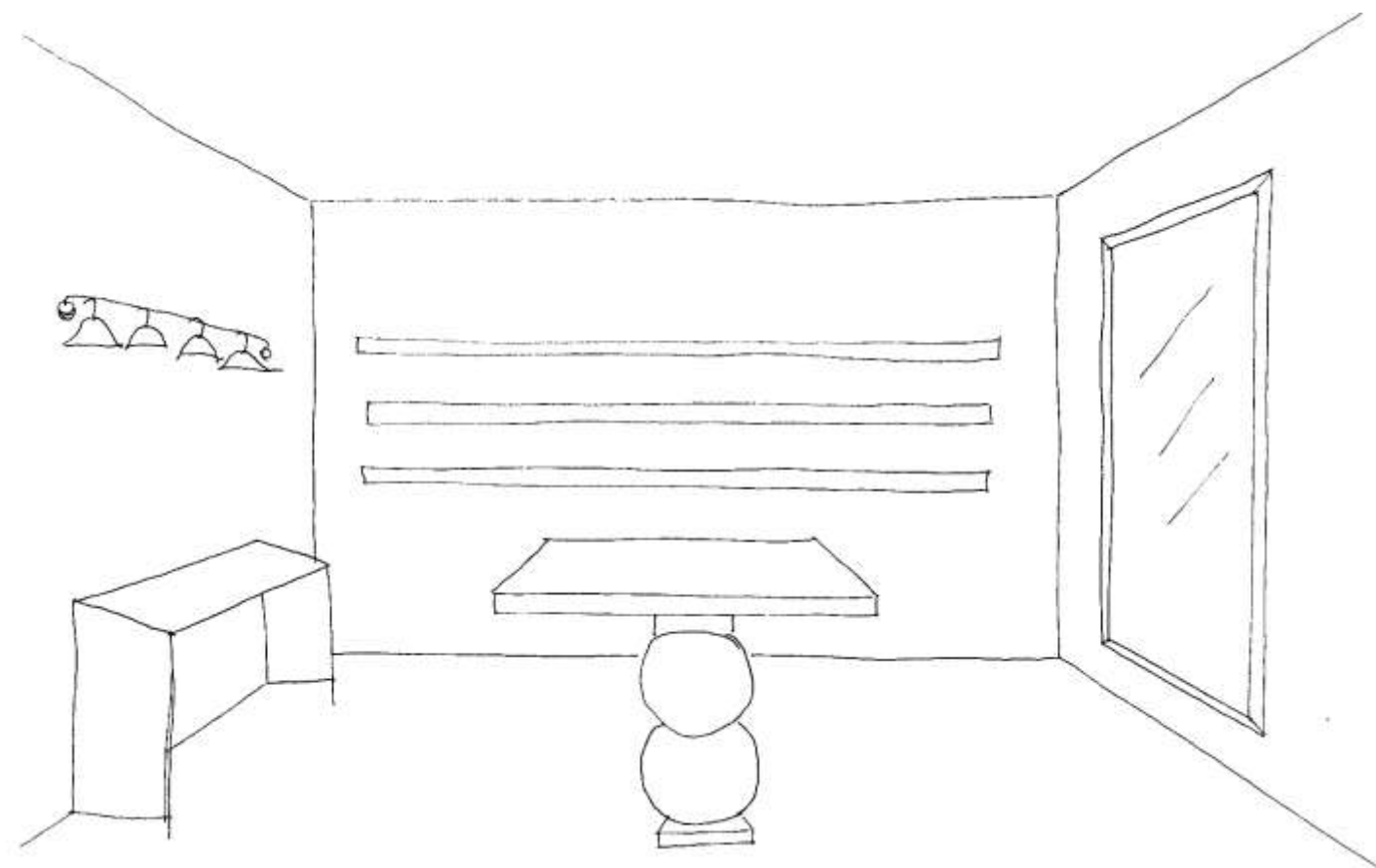
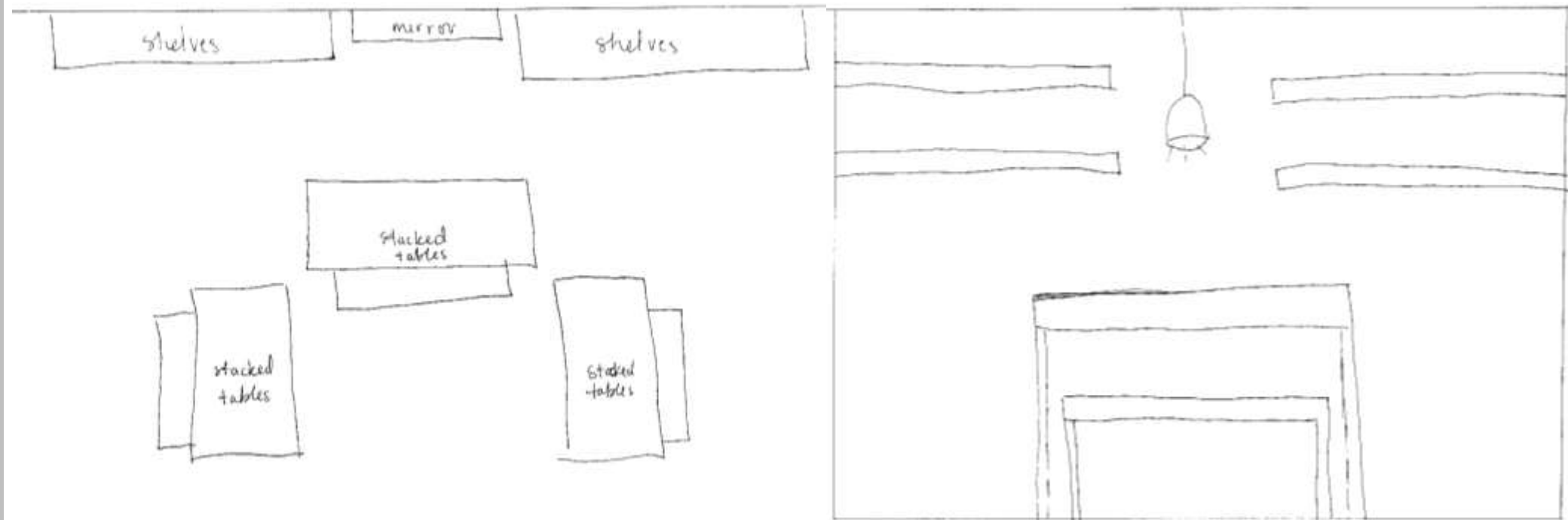

Carrie Thompson
IDSN 2102 F19

Assignment 3C: Activity Space Studies- Incorporating the Music Model into the design

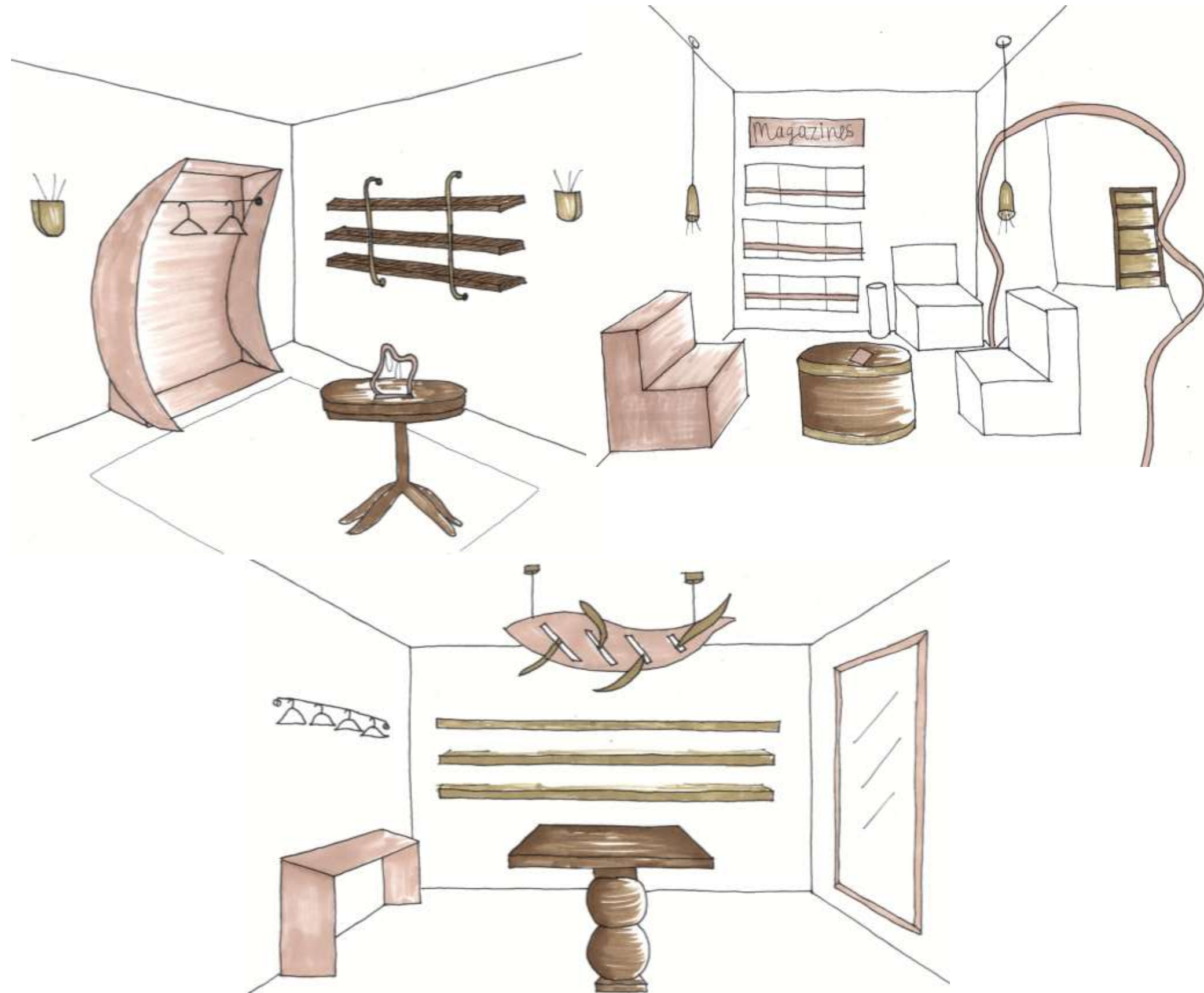

Carrie Thompson

IDSN 2102 F19

Assignment 4: Drawing to Music

Carrie Thompson
IDSN 2102 F19

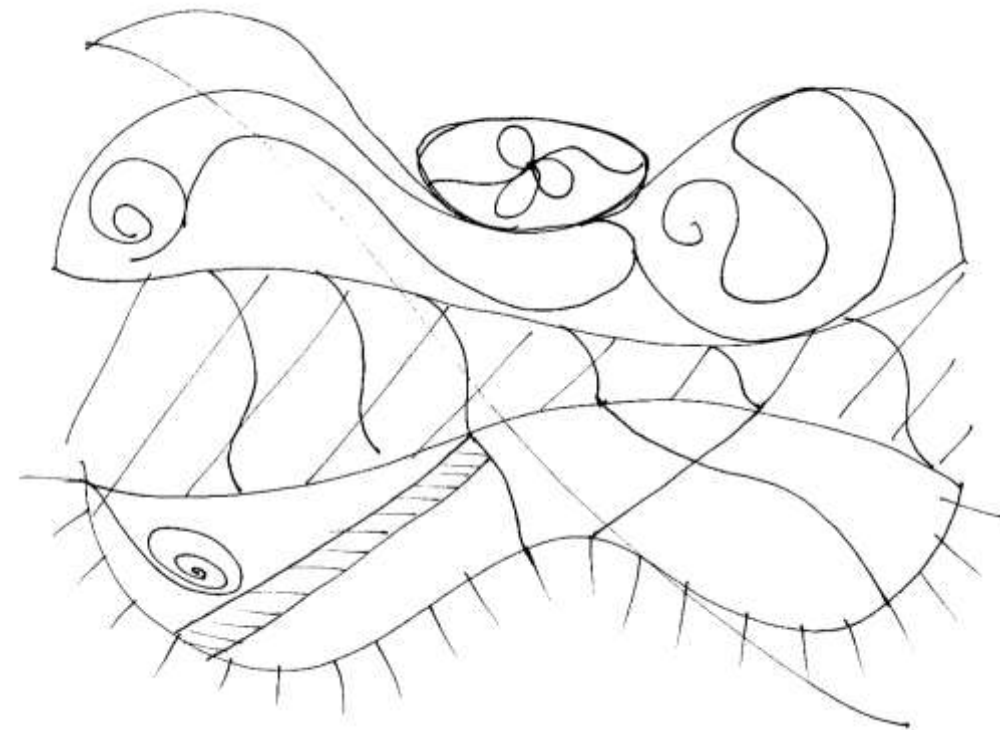
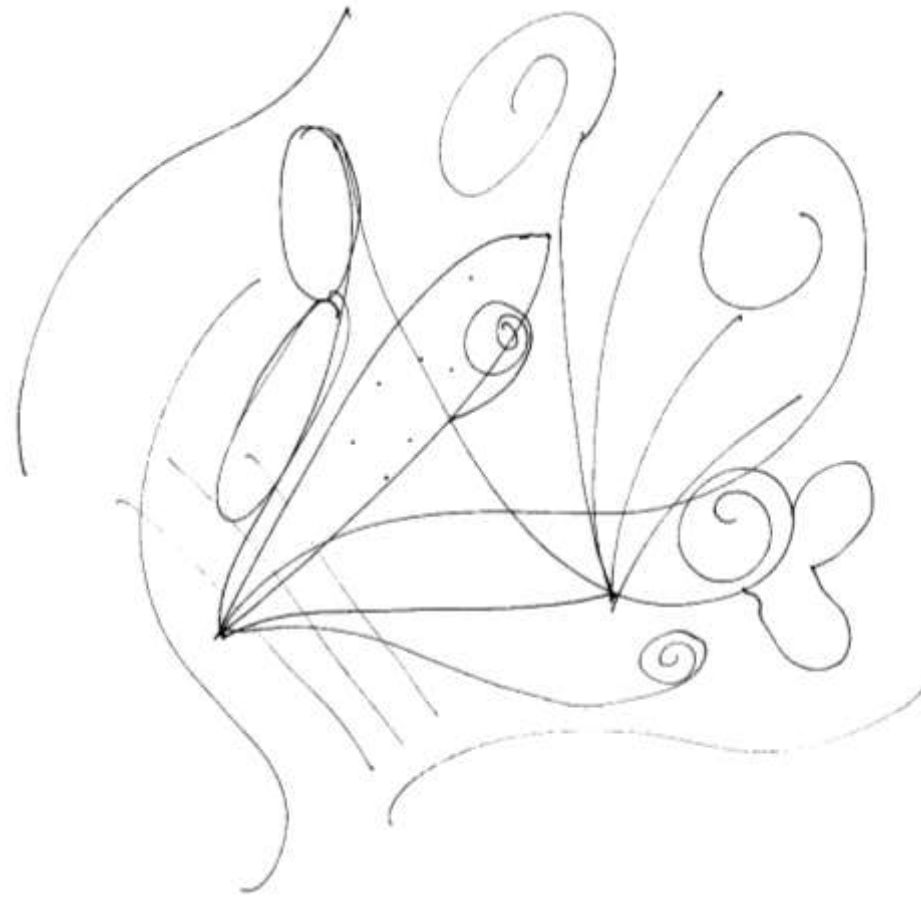

Assignment 5: Modeling to Music

Carrie Thompson

IDSN 2102 F19



**Assignment 6: Auto CAD-
Circulation Plans**

Carrie Thompson

IDSN 2102 F19

