



QUICK-FIX

FAST-ACTING

Andy Vang

IDSN

Portfolio 1

Assignment 1

Architectural and Engineering Scales

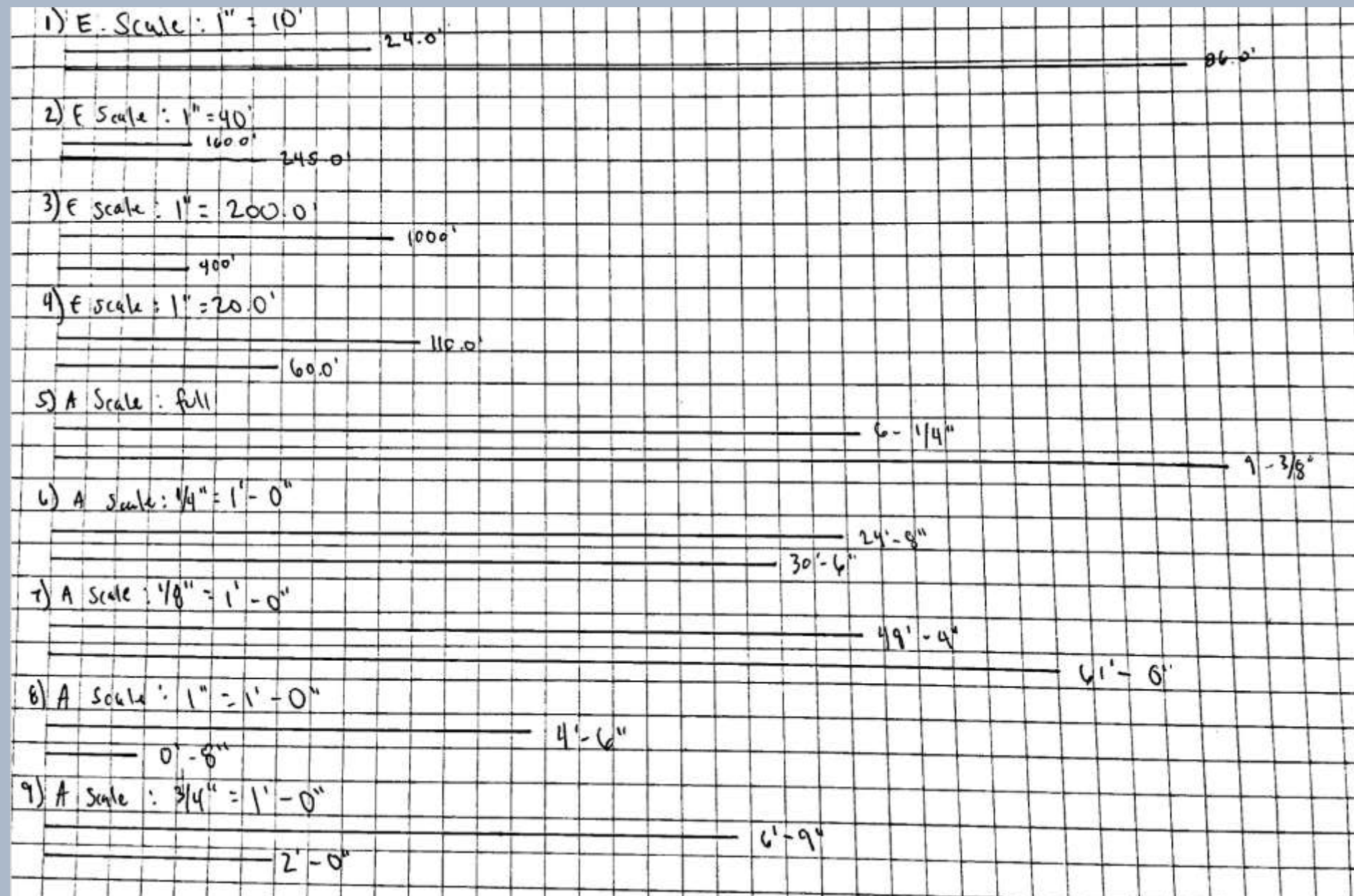

Assignment 2 Quick Sketch Competencies

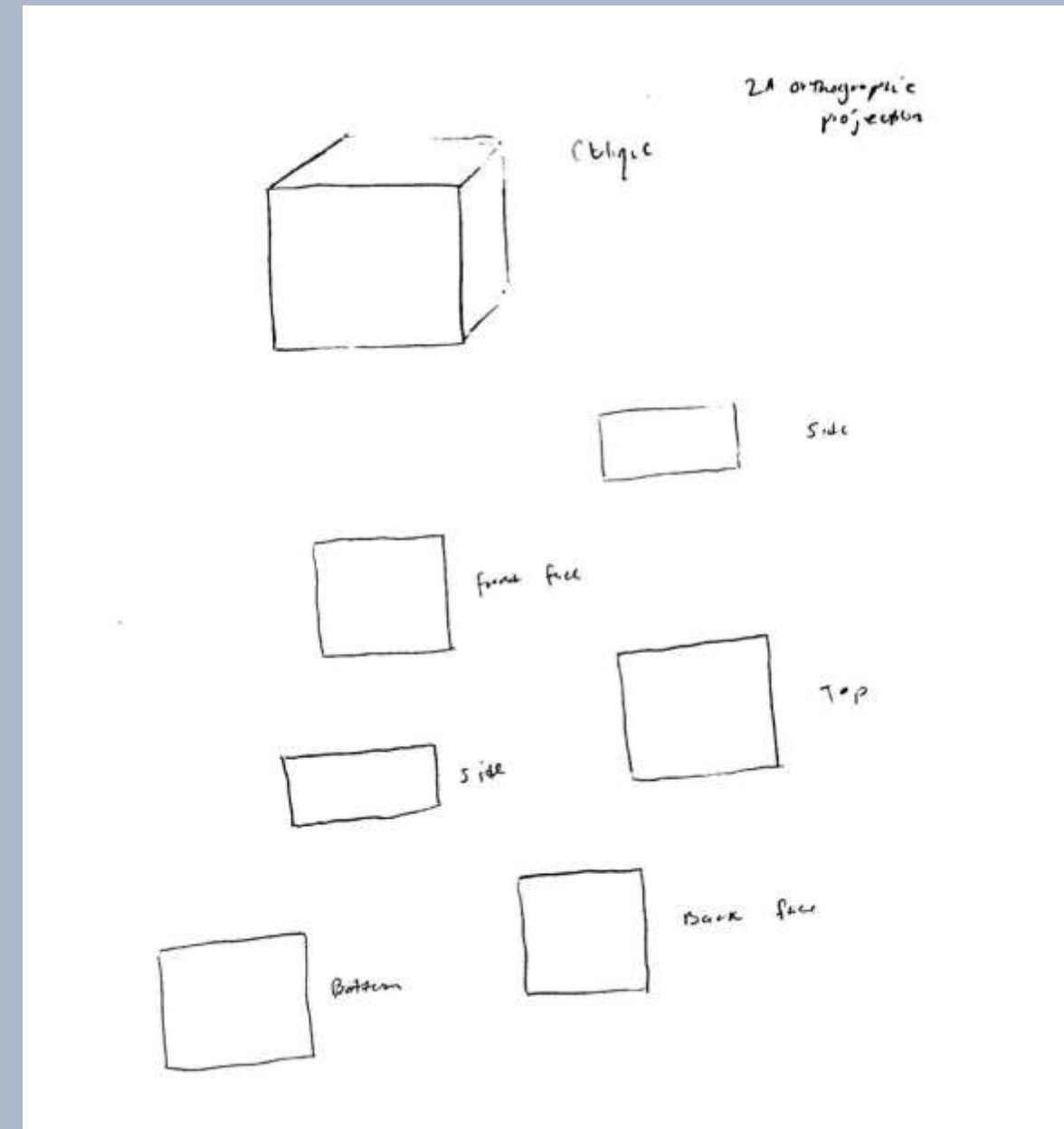
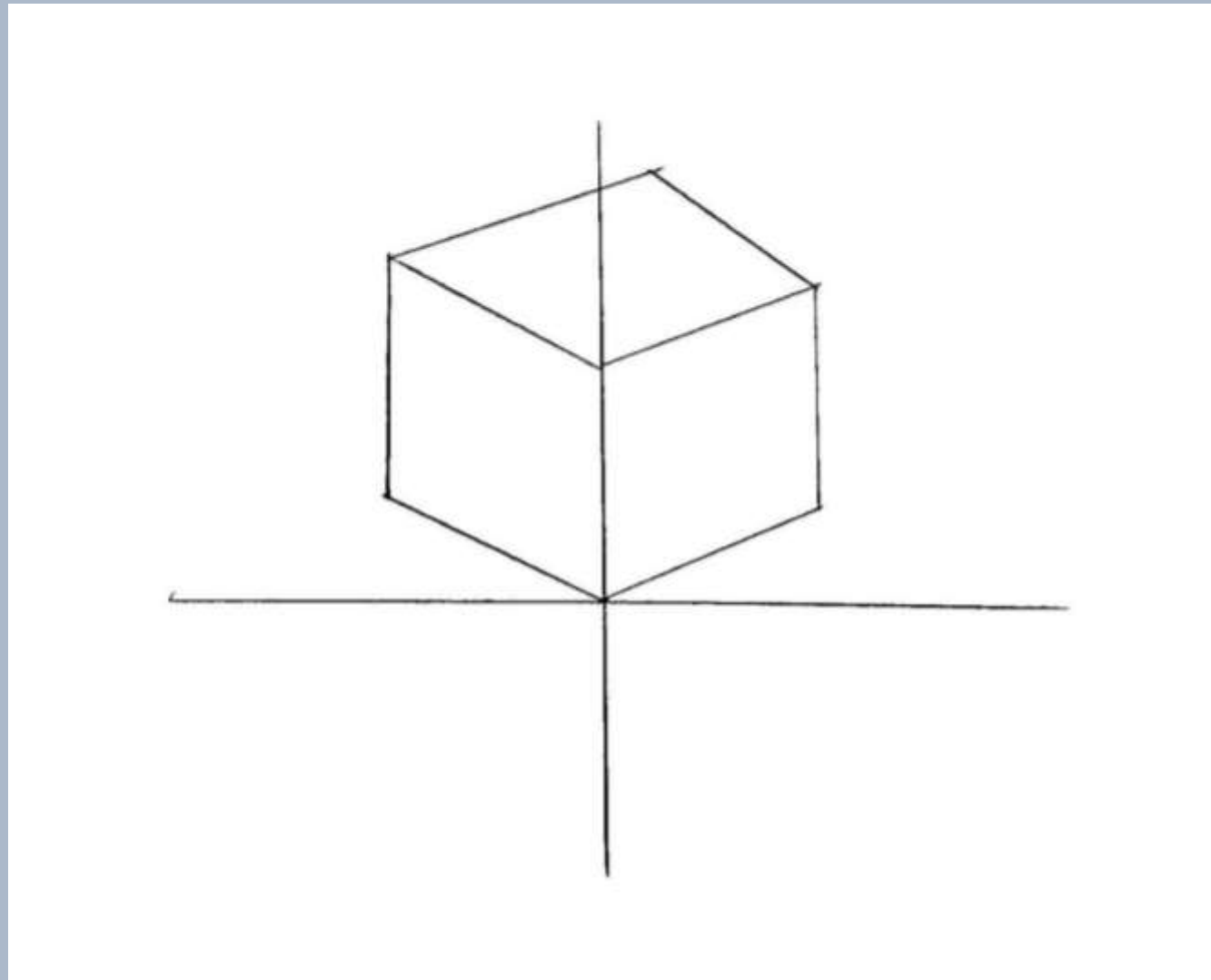

Assignment 3A
Activity Space
Studies



Andy Vang IDS N 2102 F19

Assignment 3A
Activity Space
Studies

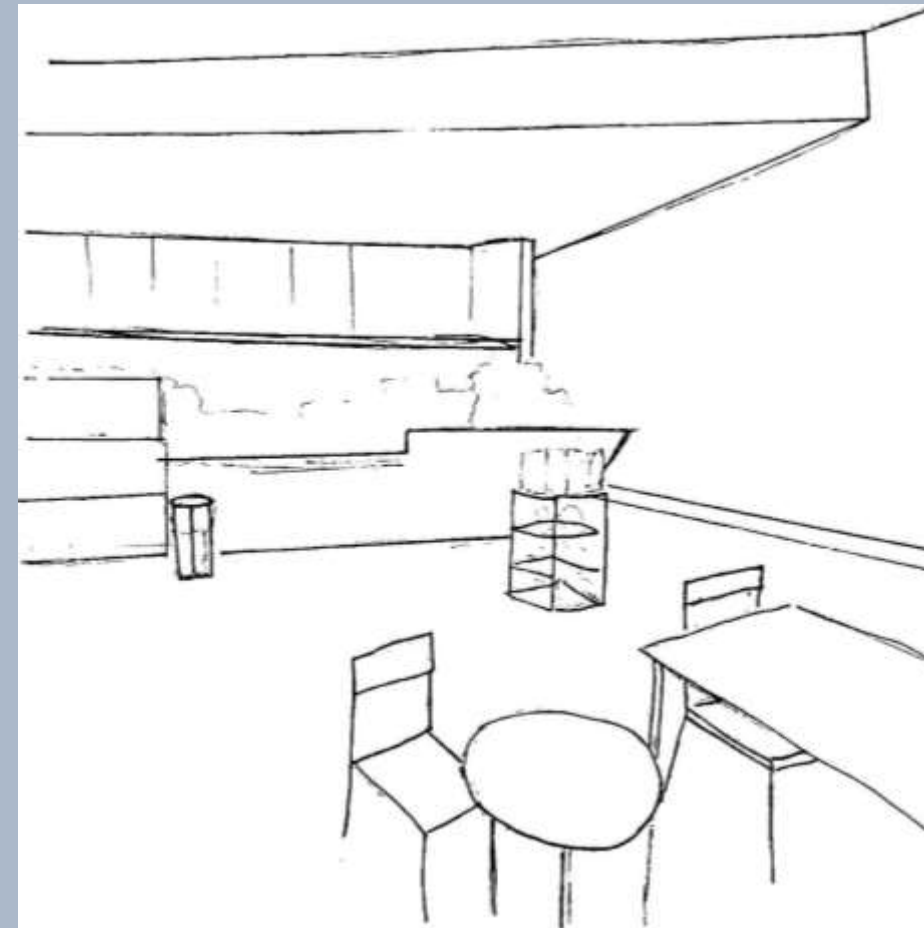
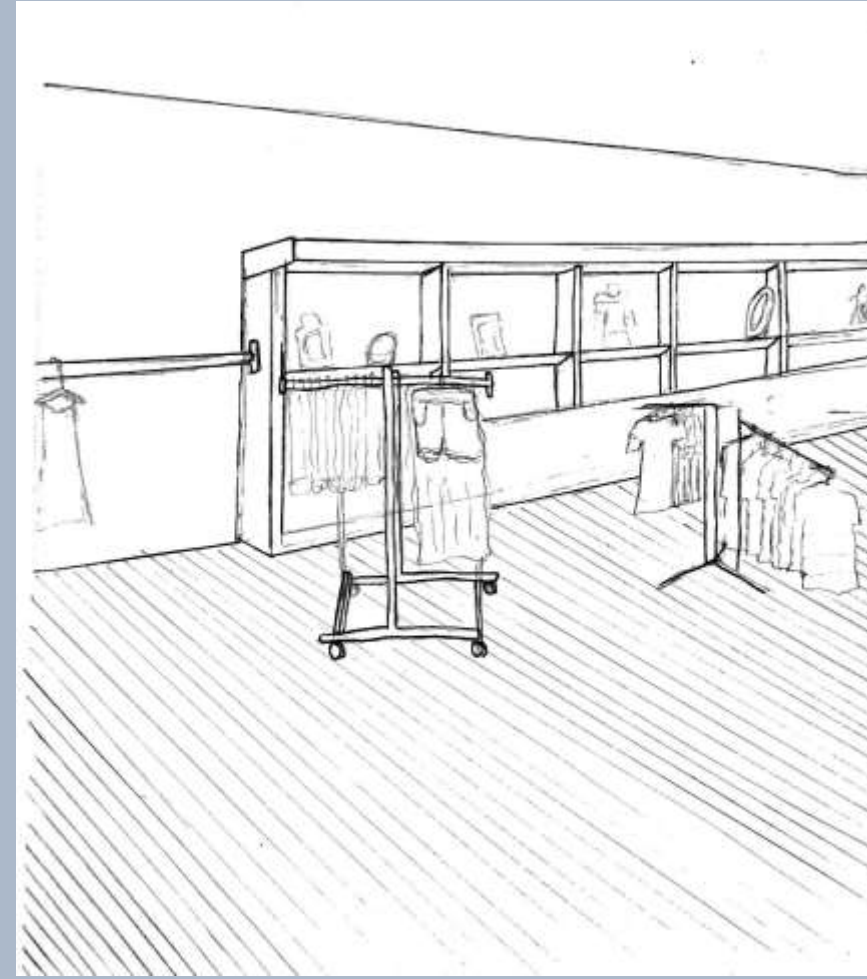
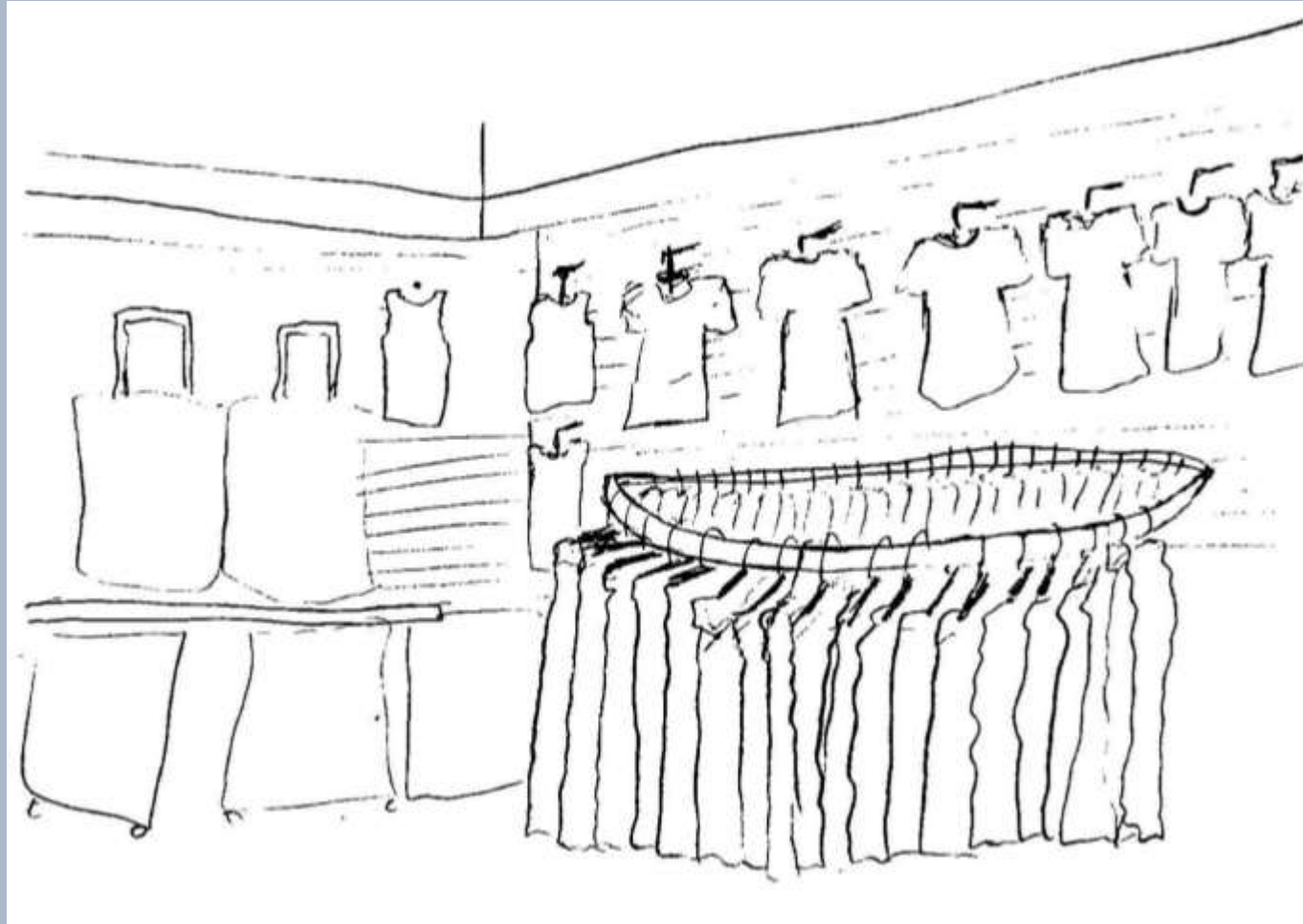

Andy Vang IDS N 2102 F19

Assignment 3B Activity Space Studies

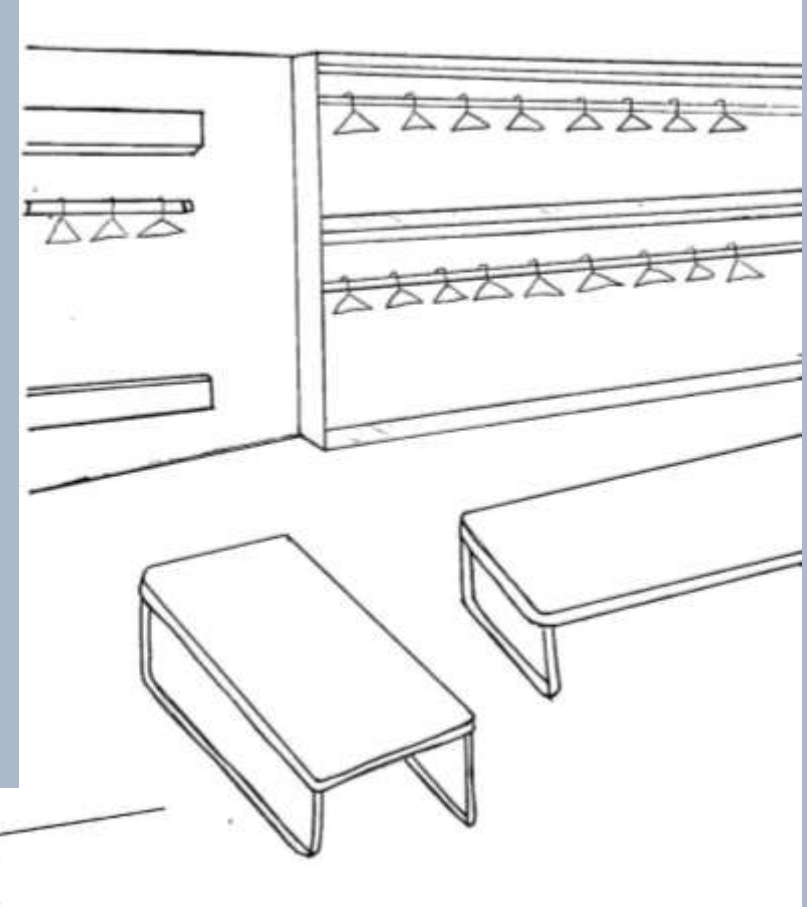
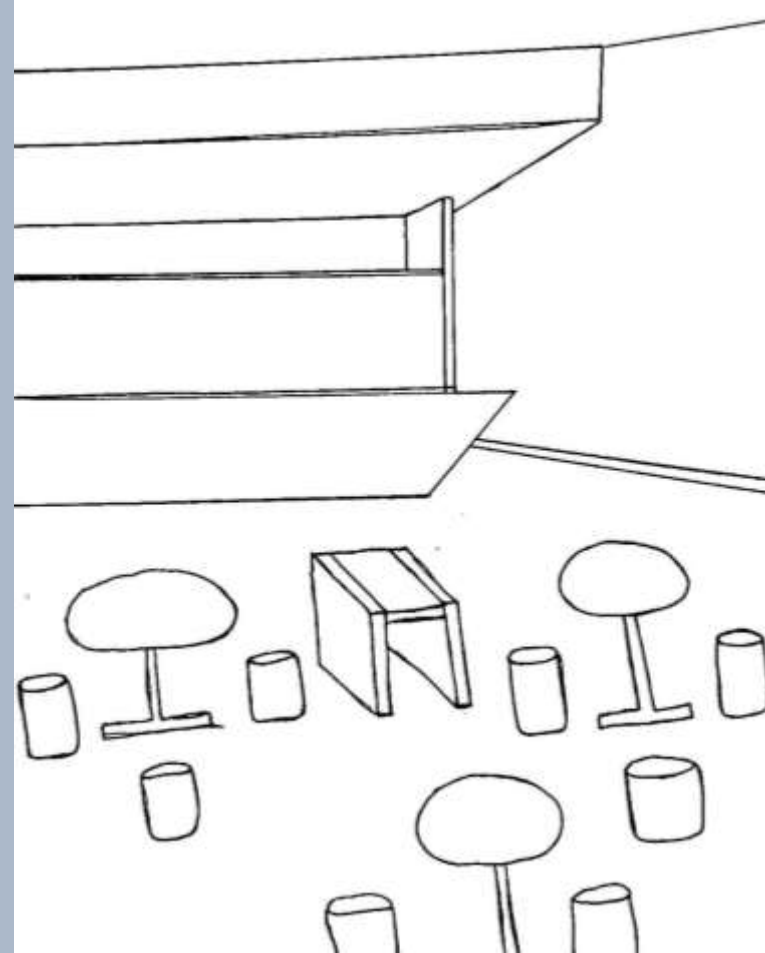
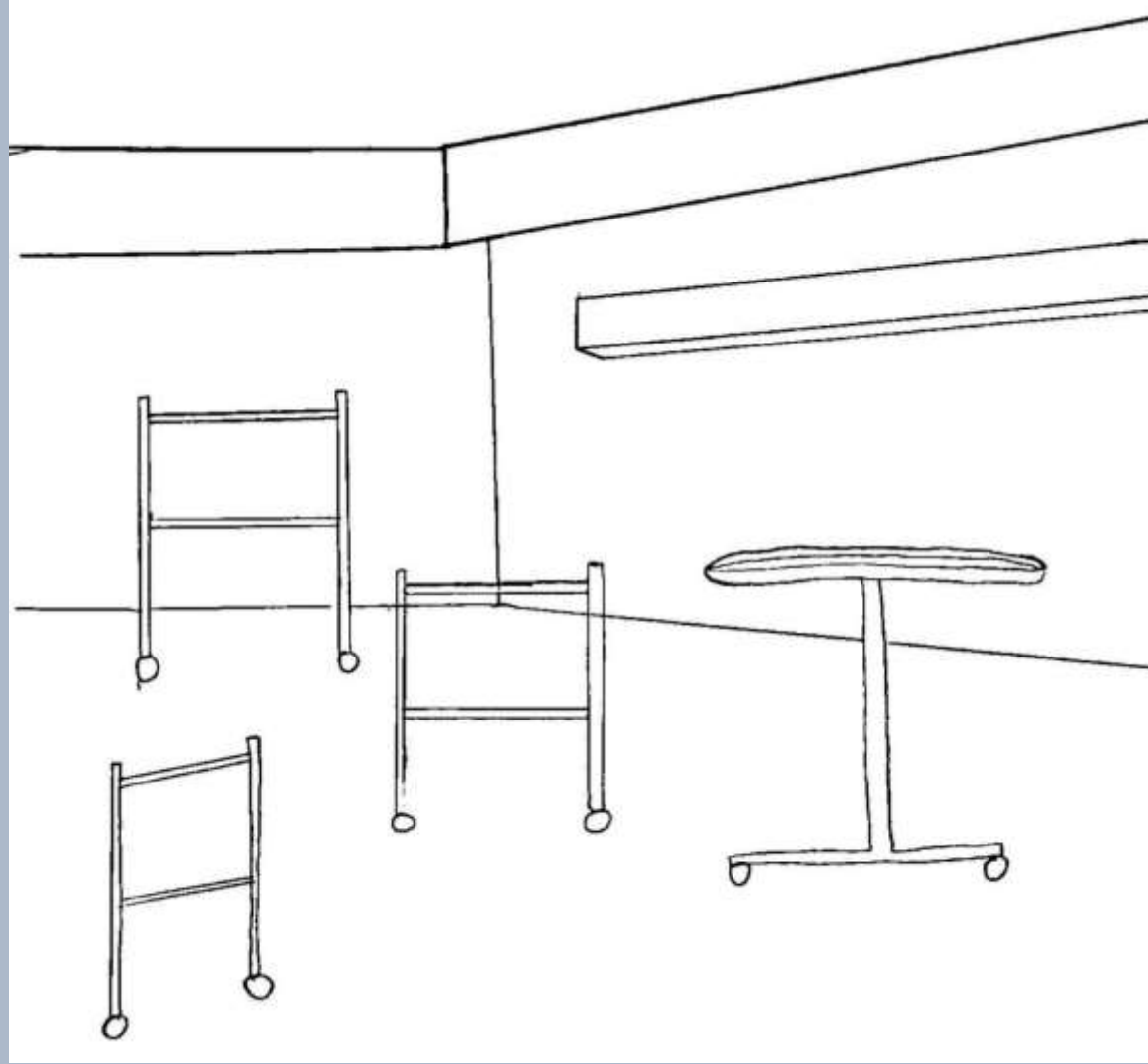

Andy Vang IDS N 2102 F19

Assignment 3B

Section Drawings

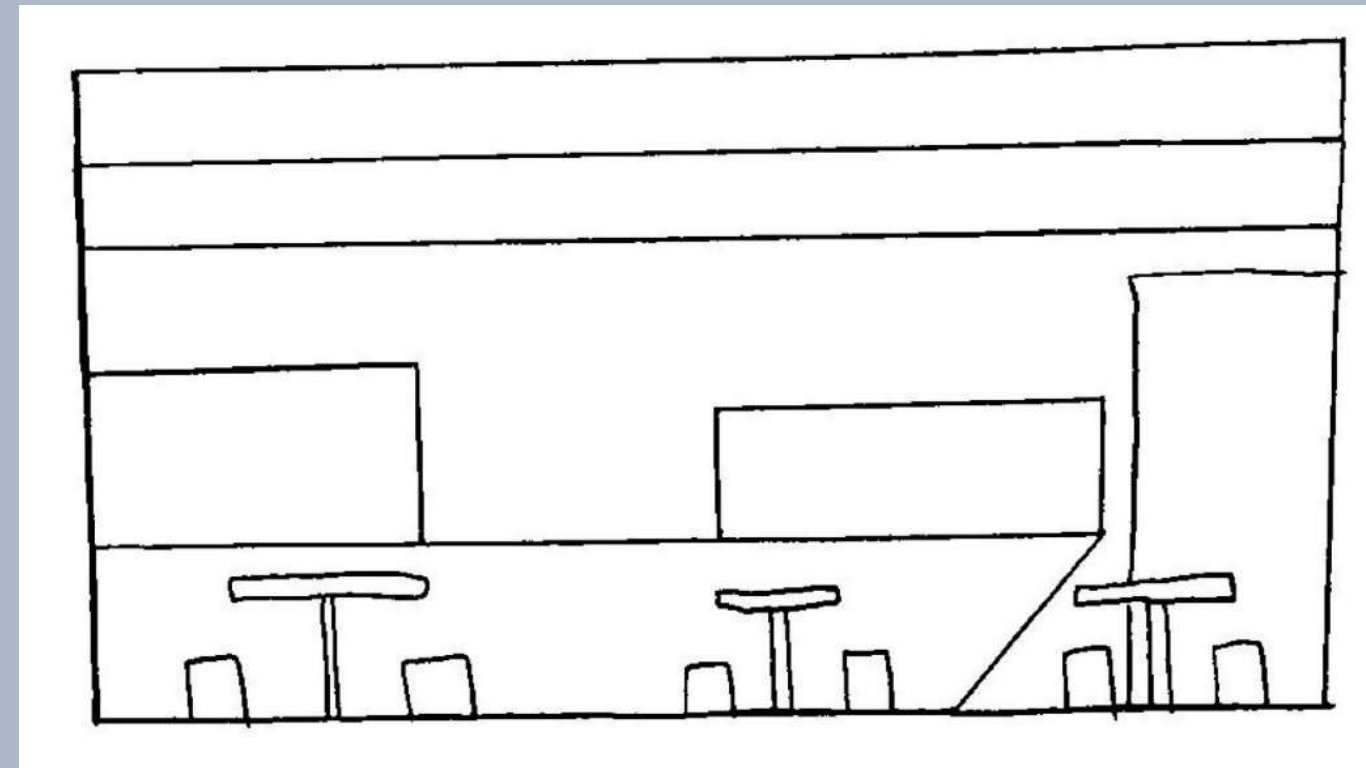
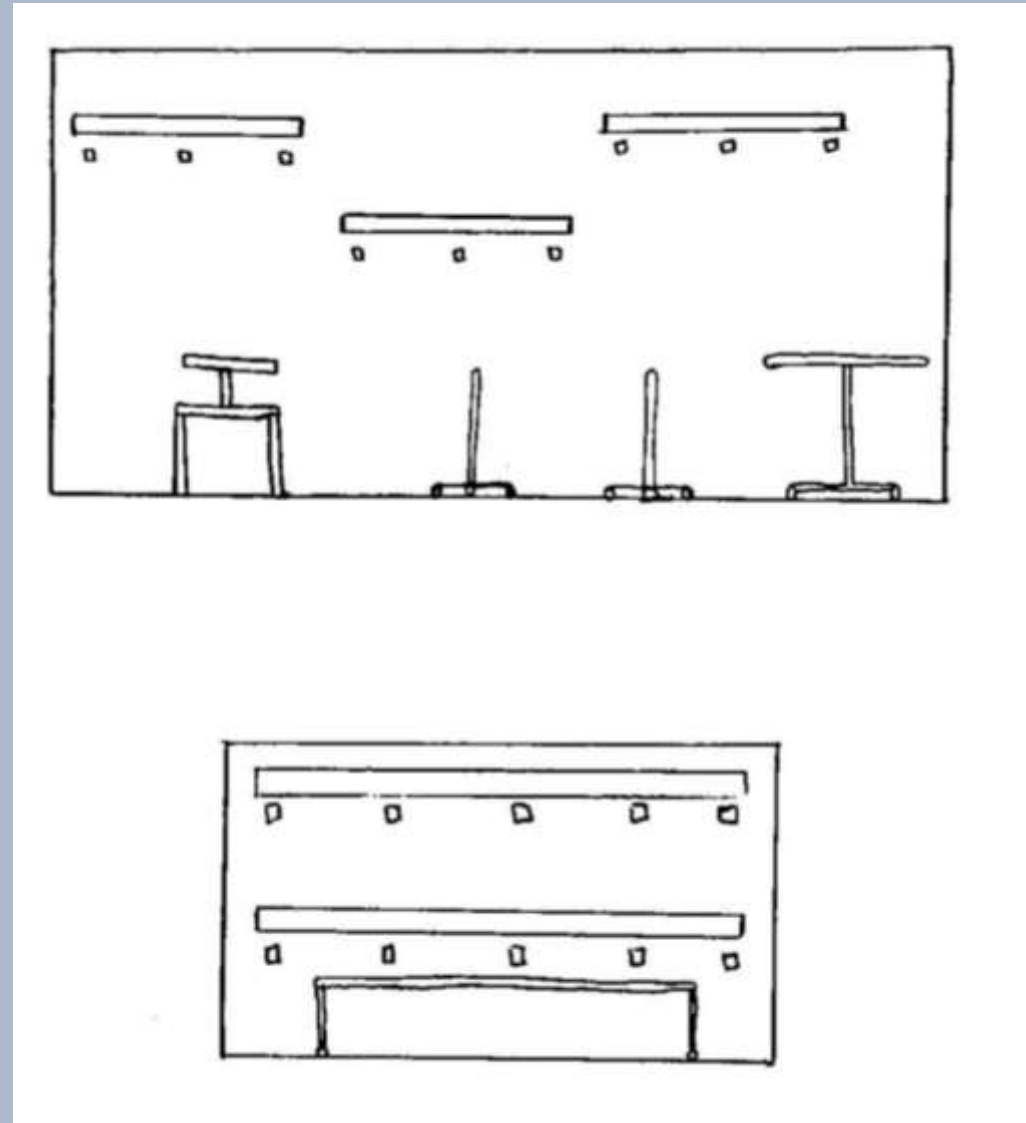
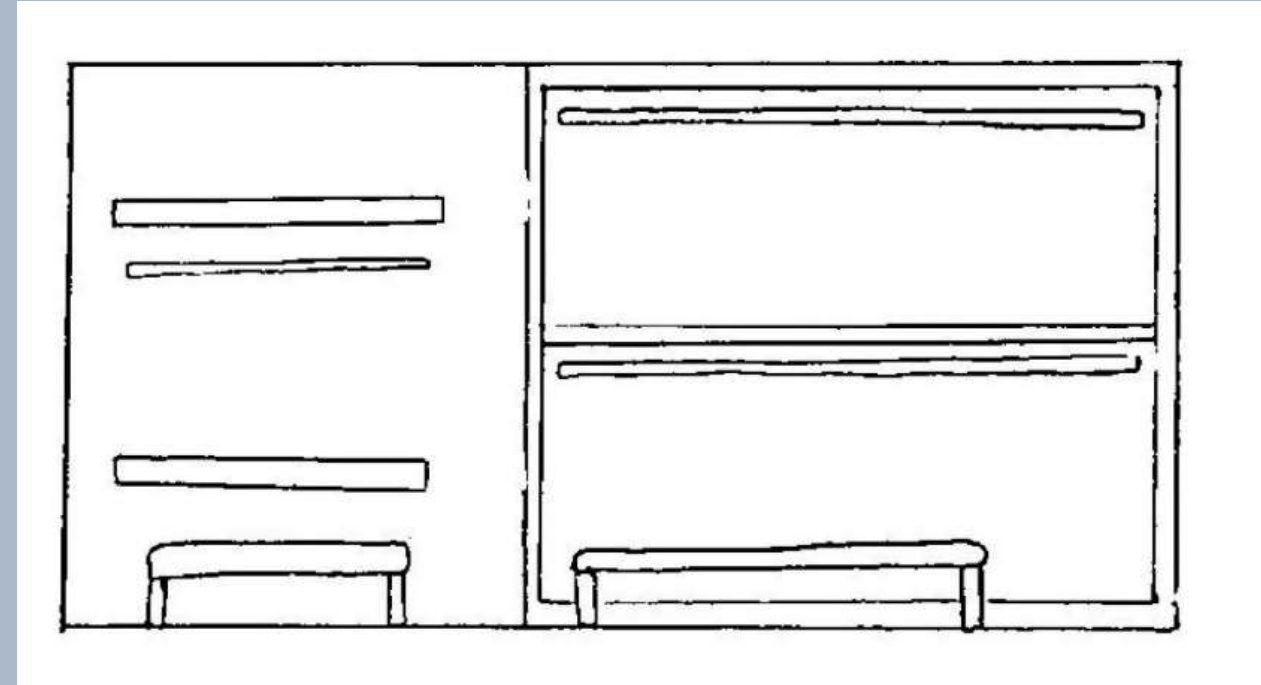

Assignment 3B Floor Plans

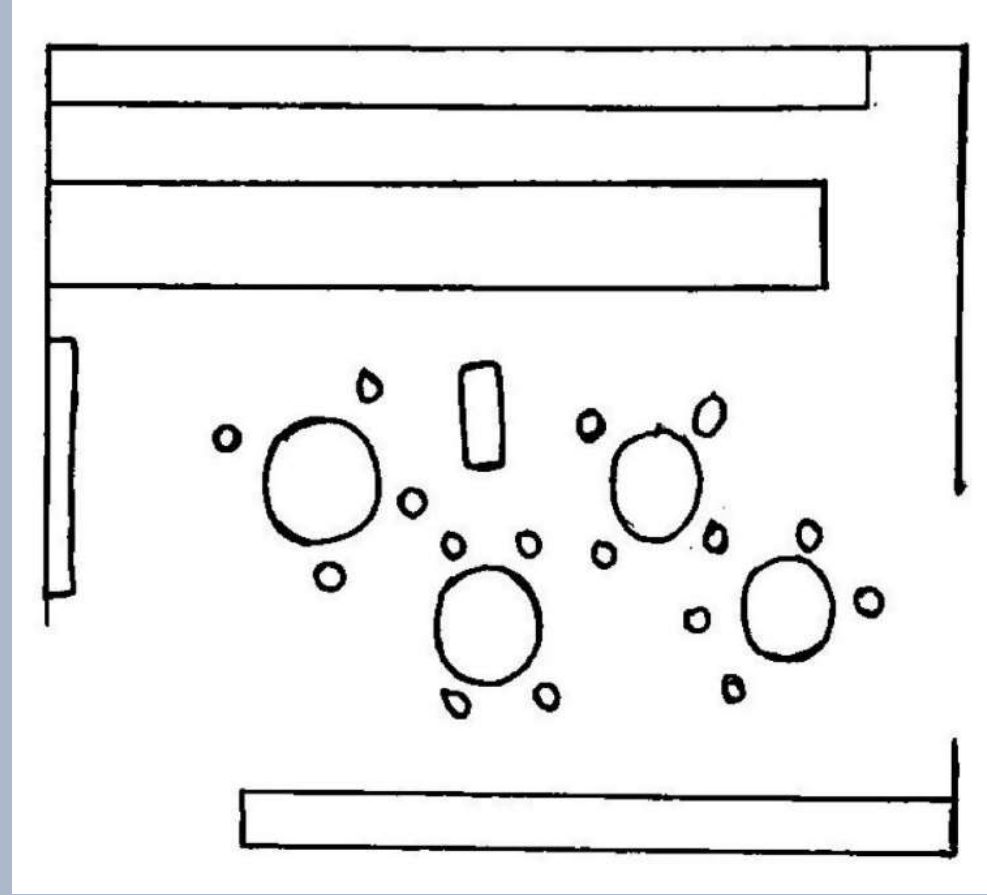
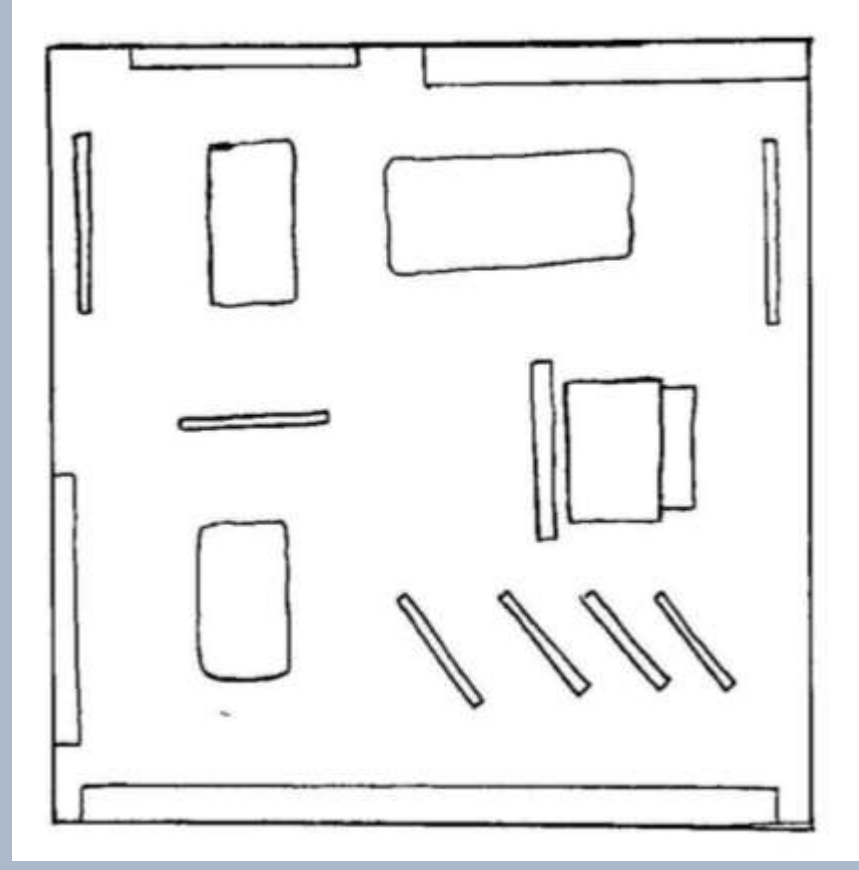
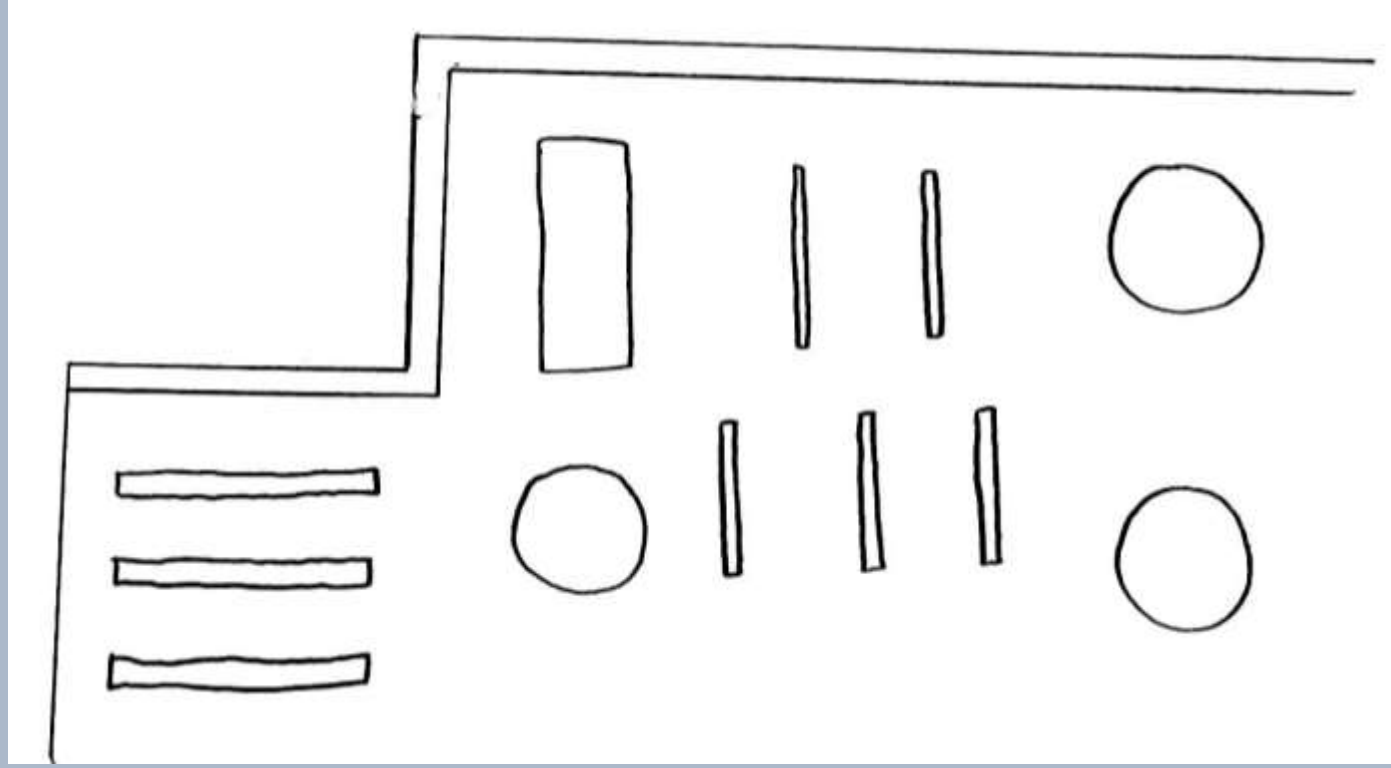

Andy Vang IDSN 2102 F19

Assignment 3C
Music Model
Incorporation

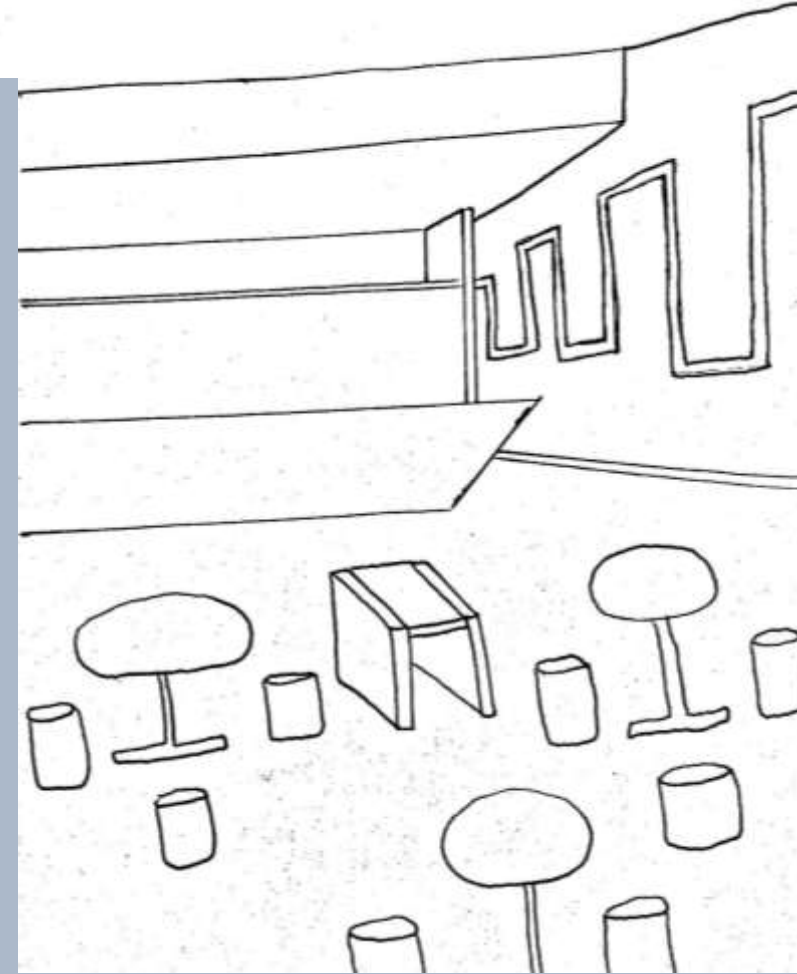
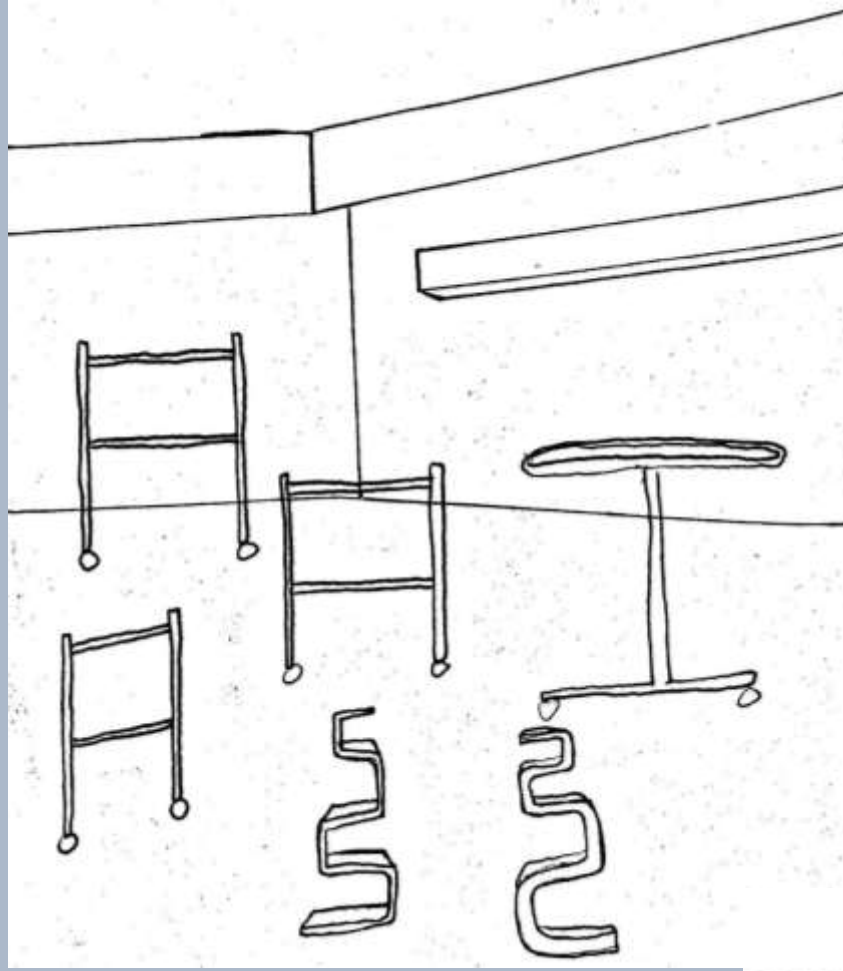
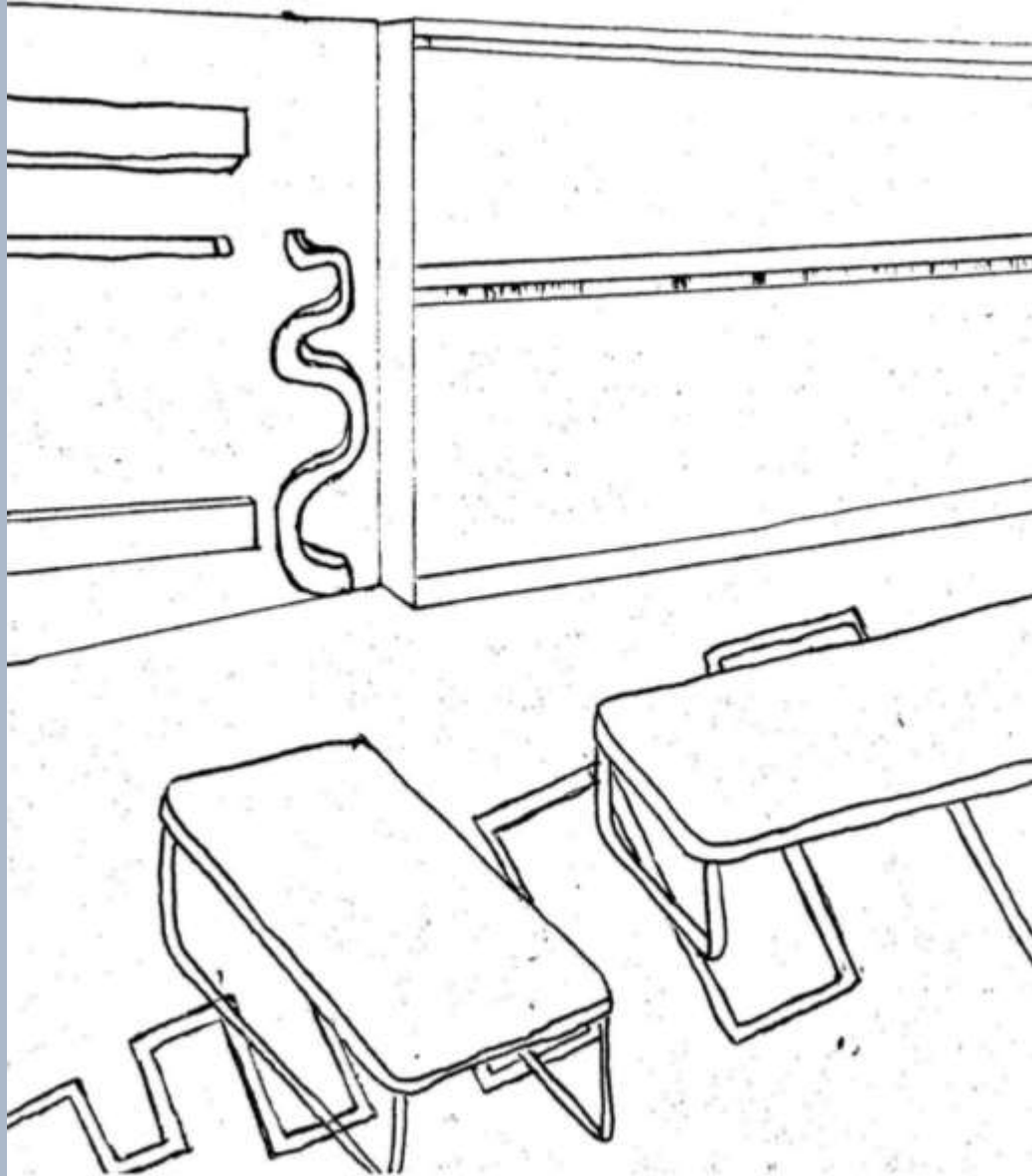

Andy Vang IDSN 2102 F19

Assignment 4A &
4B
Drawing to
Music

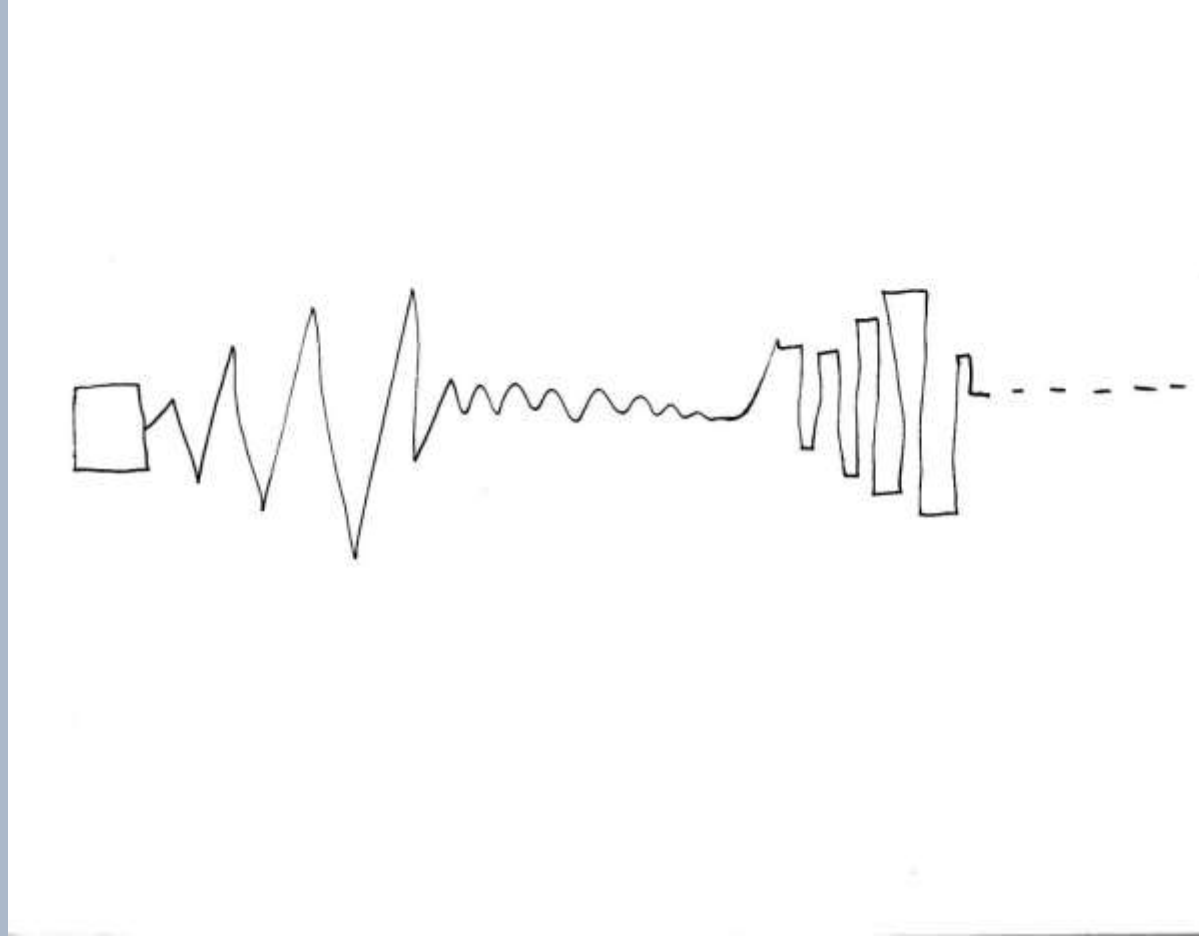
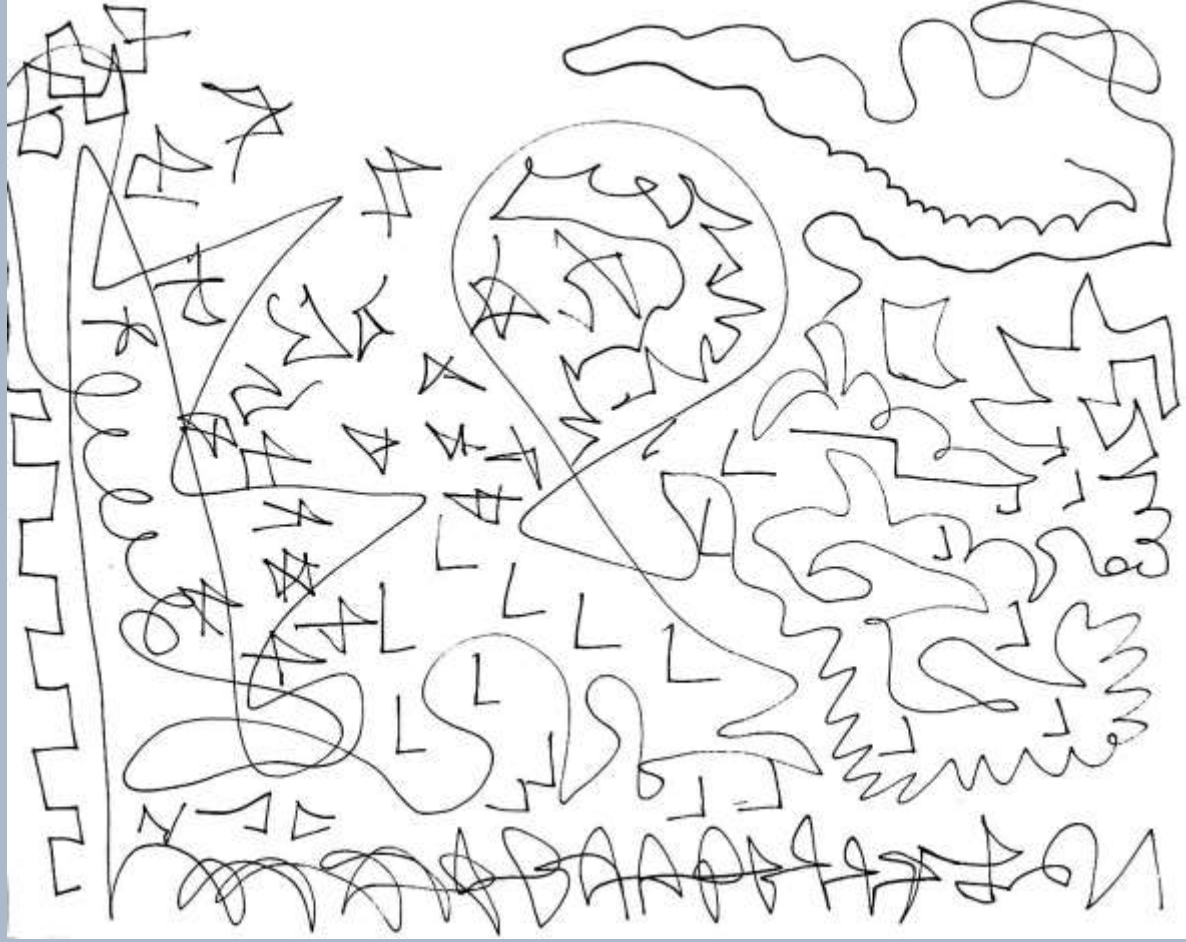
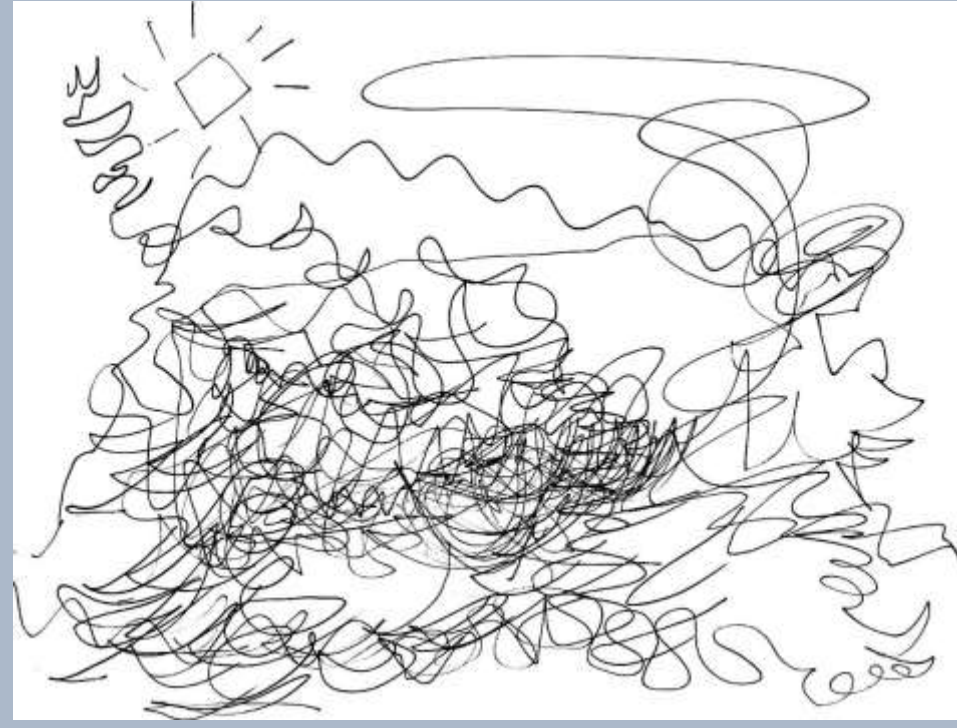

Assignment 5
Modeling to
Music

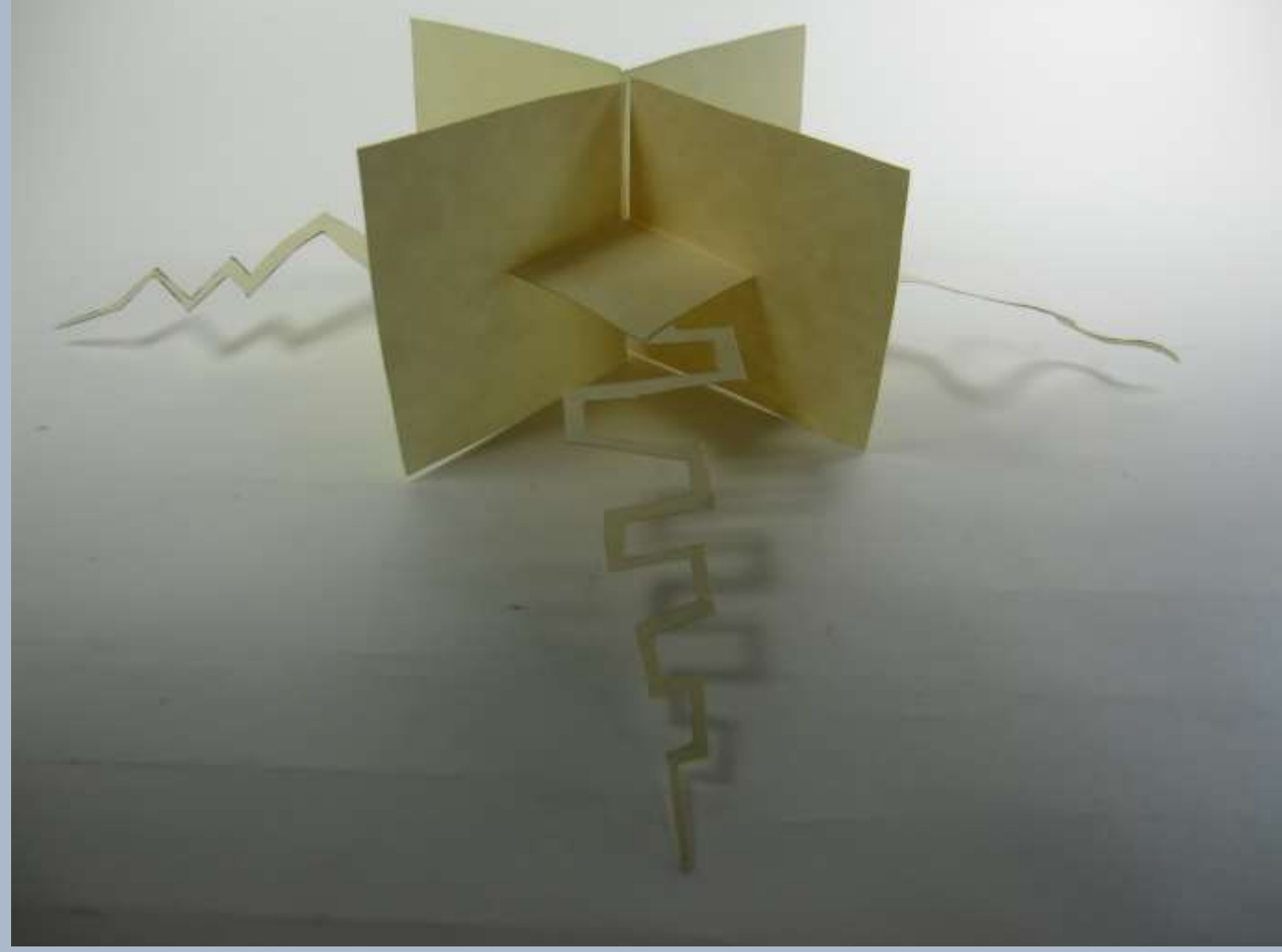
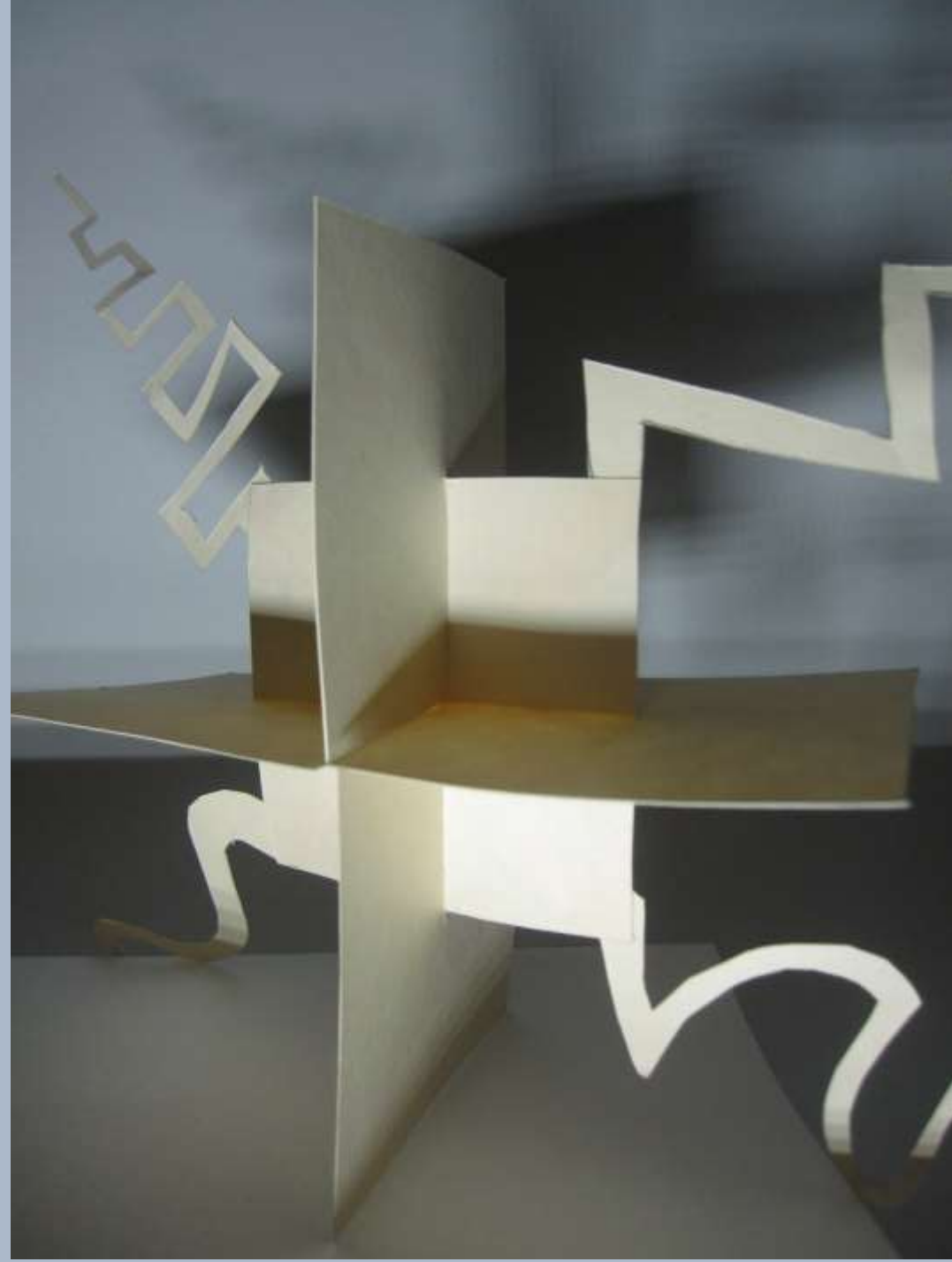

Andy Vang IDSN 2102 F19

Assignment 6 Circulation Plans

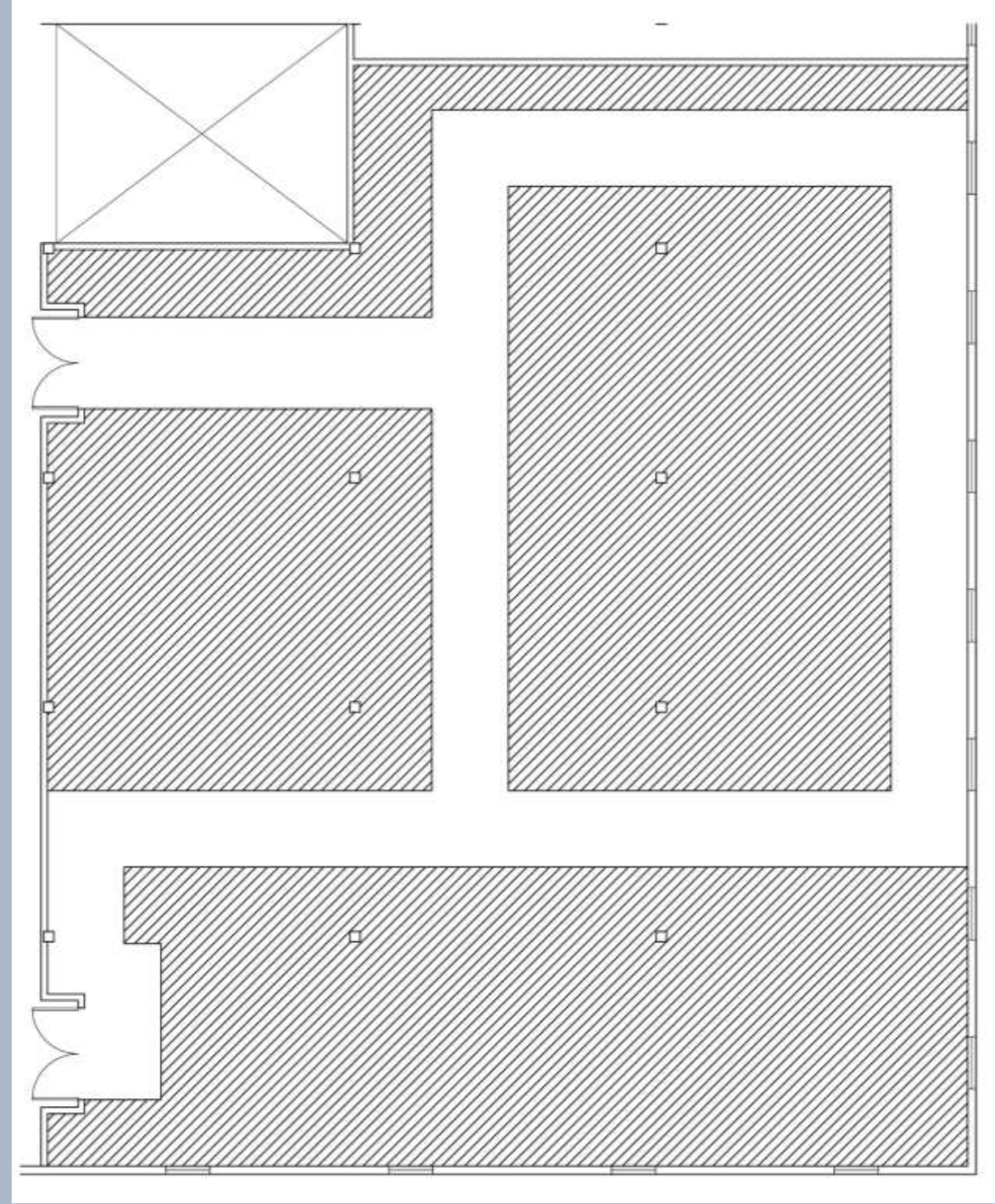
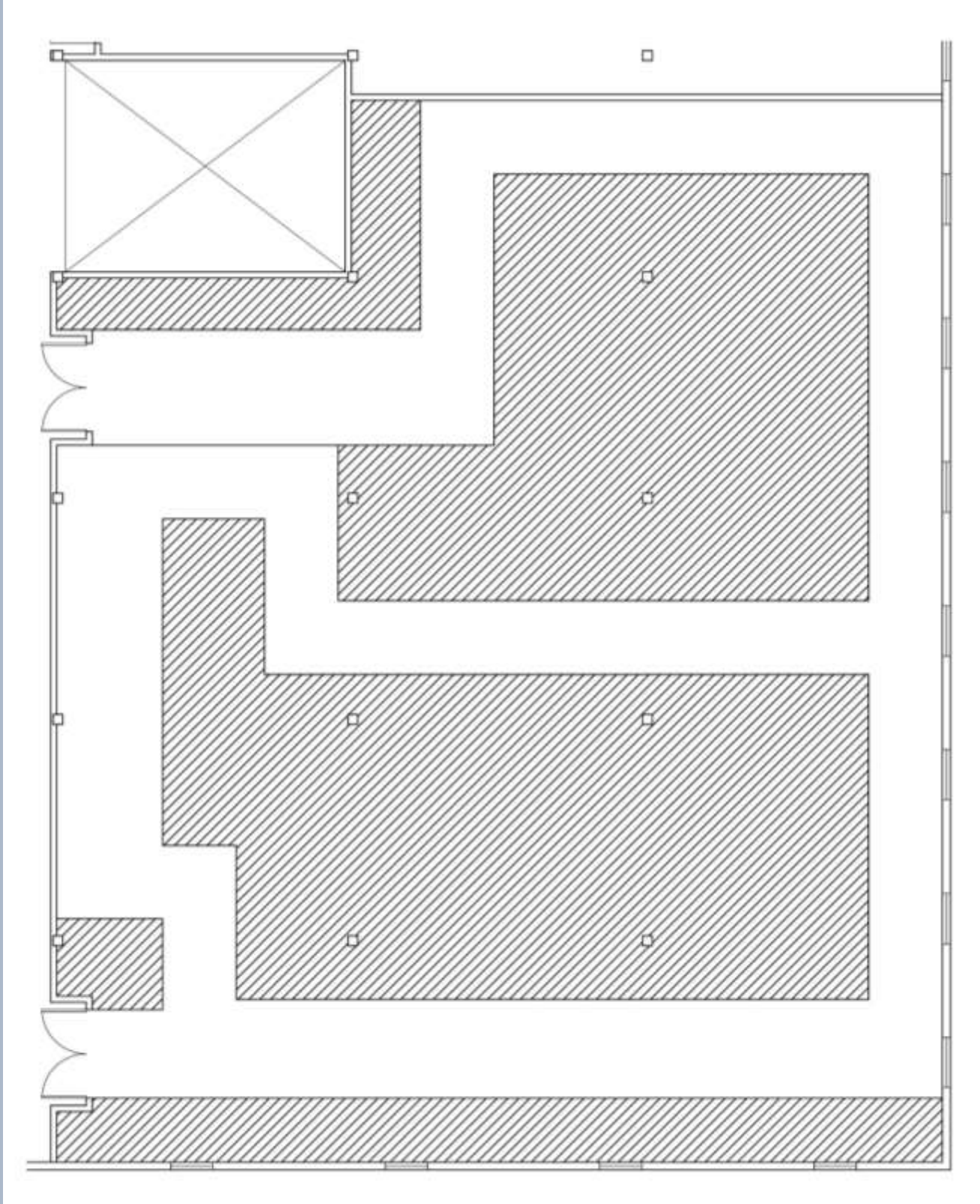

Andy Vang IDSN 2102 F19