

Portfolio

IDSN 3600: Systems

Victoria Miller

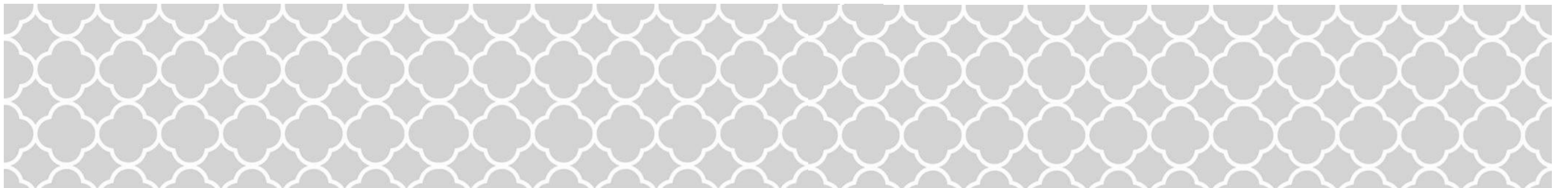

Programming

1



Target Buyers

- Retirees
- 55+ year olds
- Grandparents



Programming

The Condo

- Kitchen
 - 200-400 sq.ft.
- Living/Dining Room
 - 300-600 sq.ft.
- Powder Room
 - 25-50 sq.ft.
- Master Suite
 - 300-500 sq.ft.

- Guest Bedroom
 - 150-300 sq.ft.
- Guest Bathroom
 - 50-100 sq. ft.
- Laundry Room
 - 100-200 sq.ft.
- Bonus Room
 - 150-250 sq. ft.
- Porch/Balcony
 - 150-200 sq.ft.



Condo Layout Inspiration Sources:

- http://www.waltonwood.com/p/senior_living/floor_plans_3235/cary-nc-27511/waltonwood-cary-parkway-3235
- <http://www.55places.com/north-carolina/communities/carolina-preserve>



Programming

Option 1: Bubble Diagram

Key:



Major Adjacency

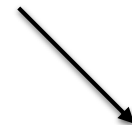

Minor Adjacency

3

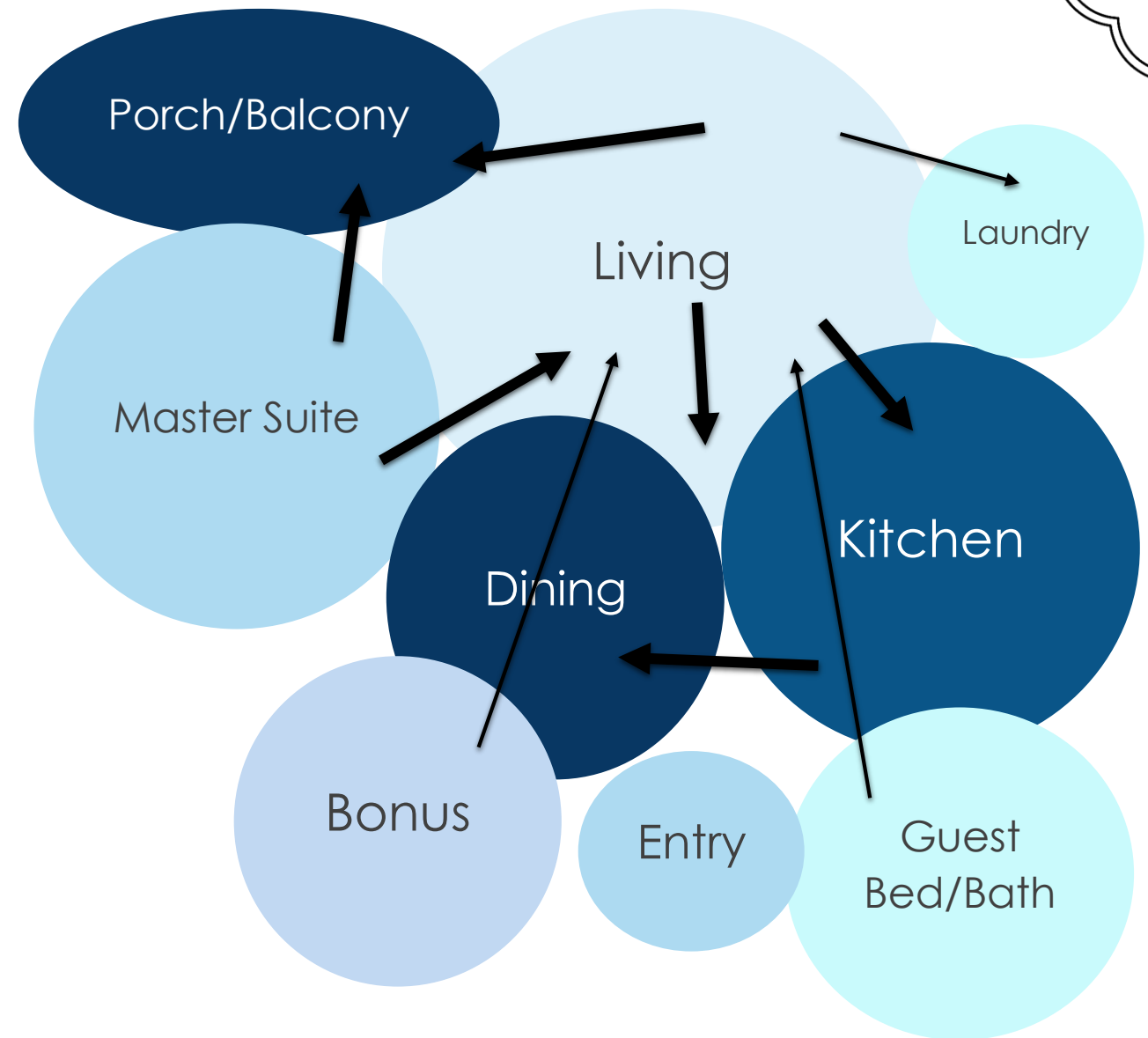

Option 1: Blocking Diagram



Option 2: Bubble Diagram

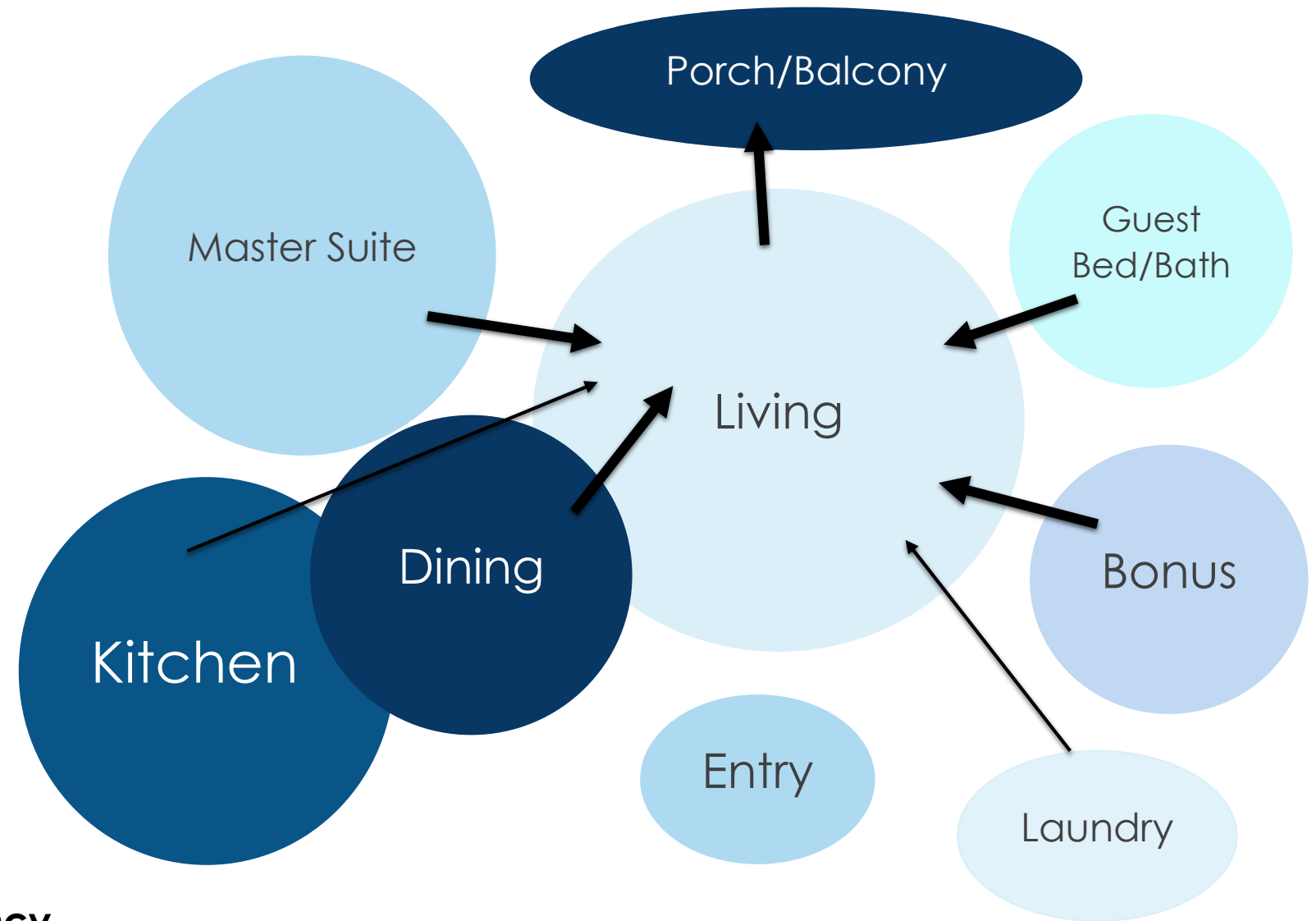

Key:





Option 2: Blocking Diagram

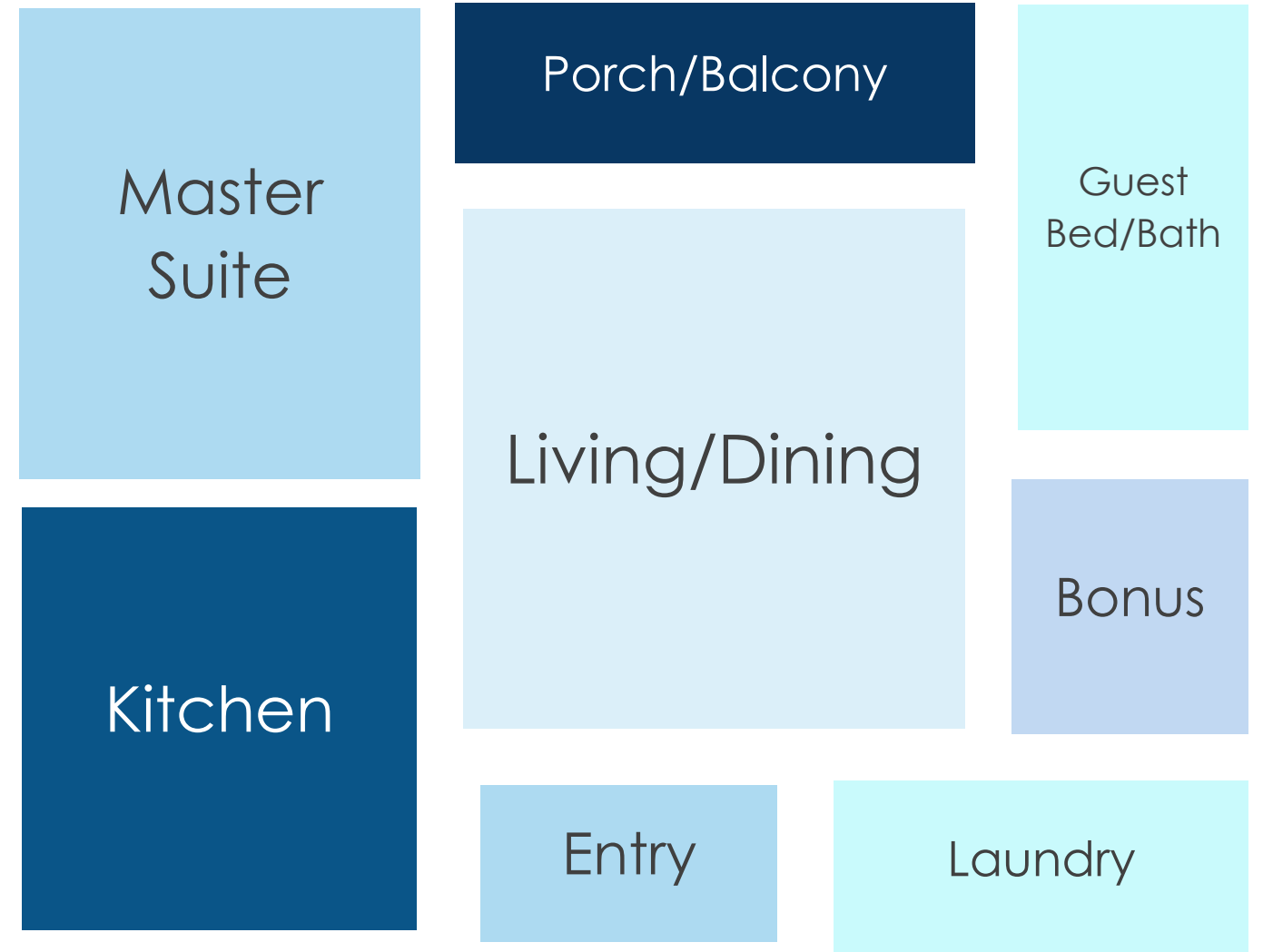

Programming

Inspiration



Programming

Inspiration

8

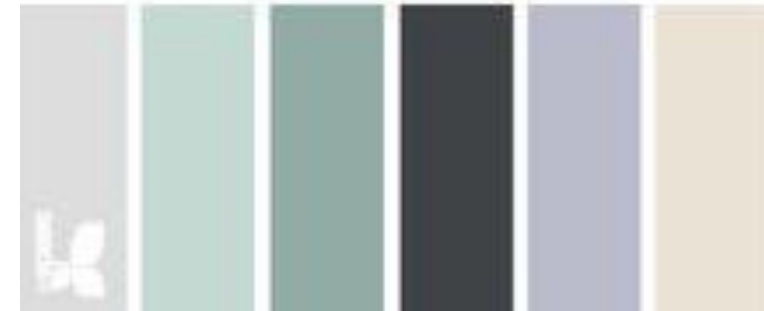

Finishes: Option 1

Living & Dining

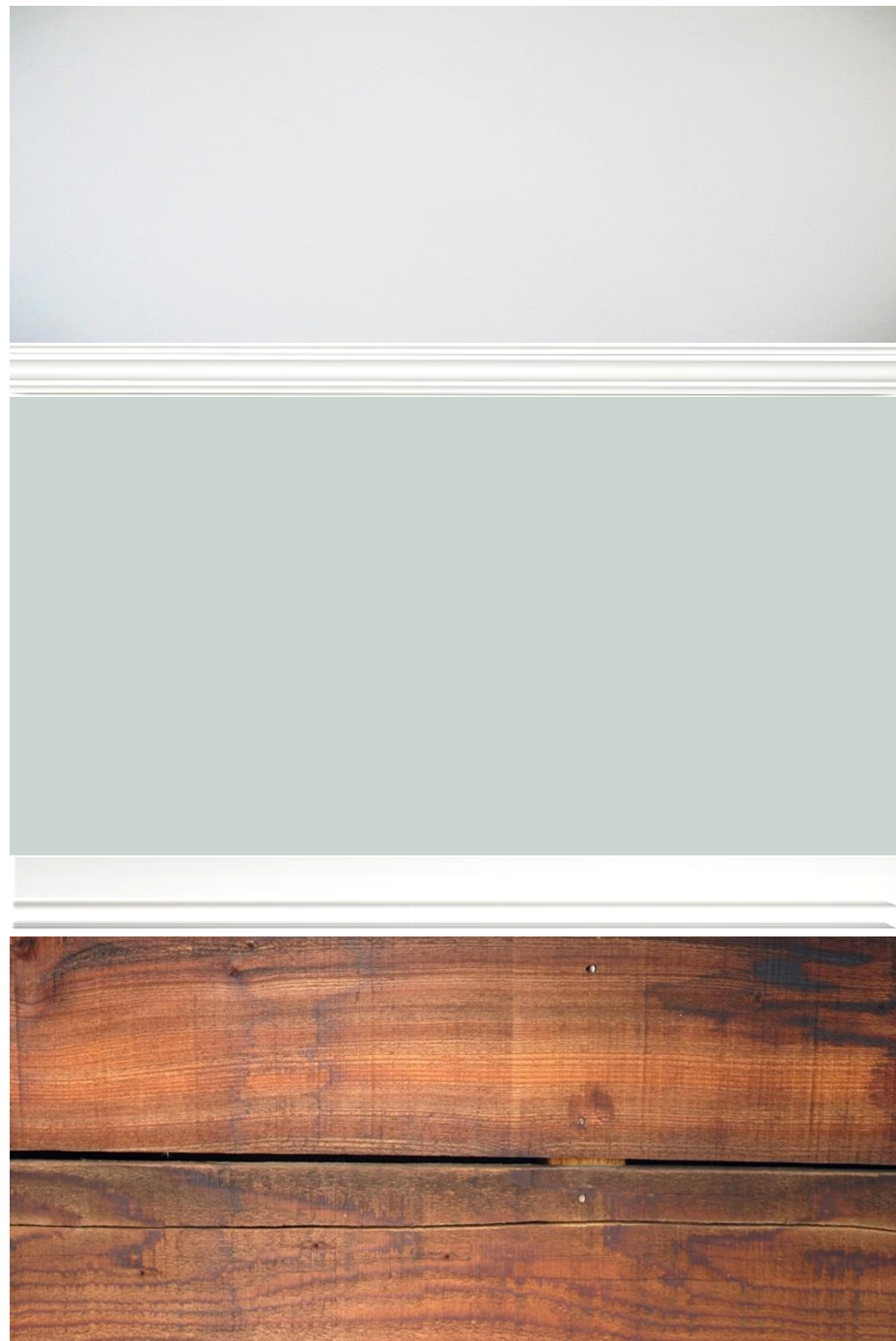

Kitchen

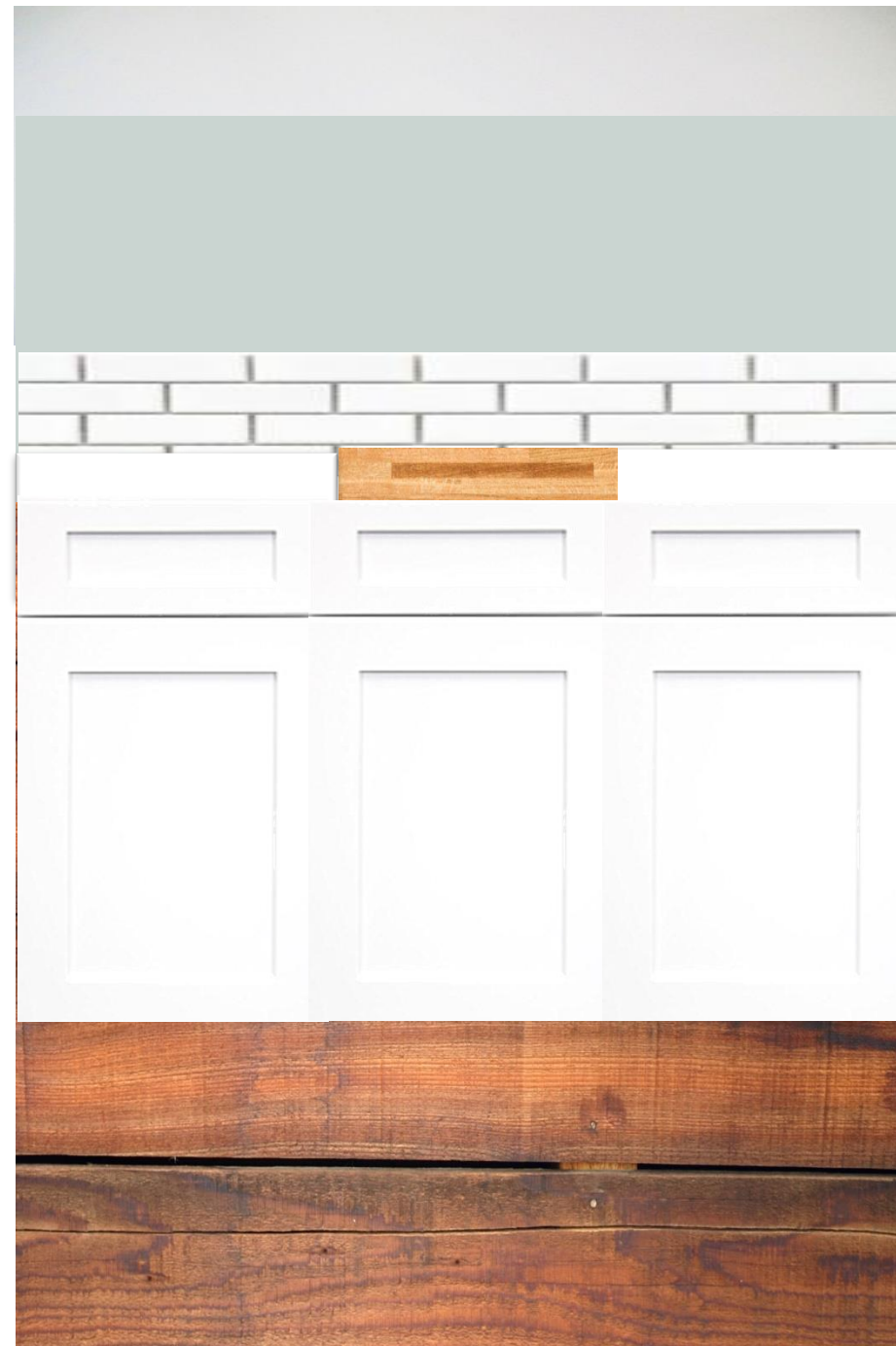

Bathroom

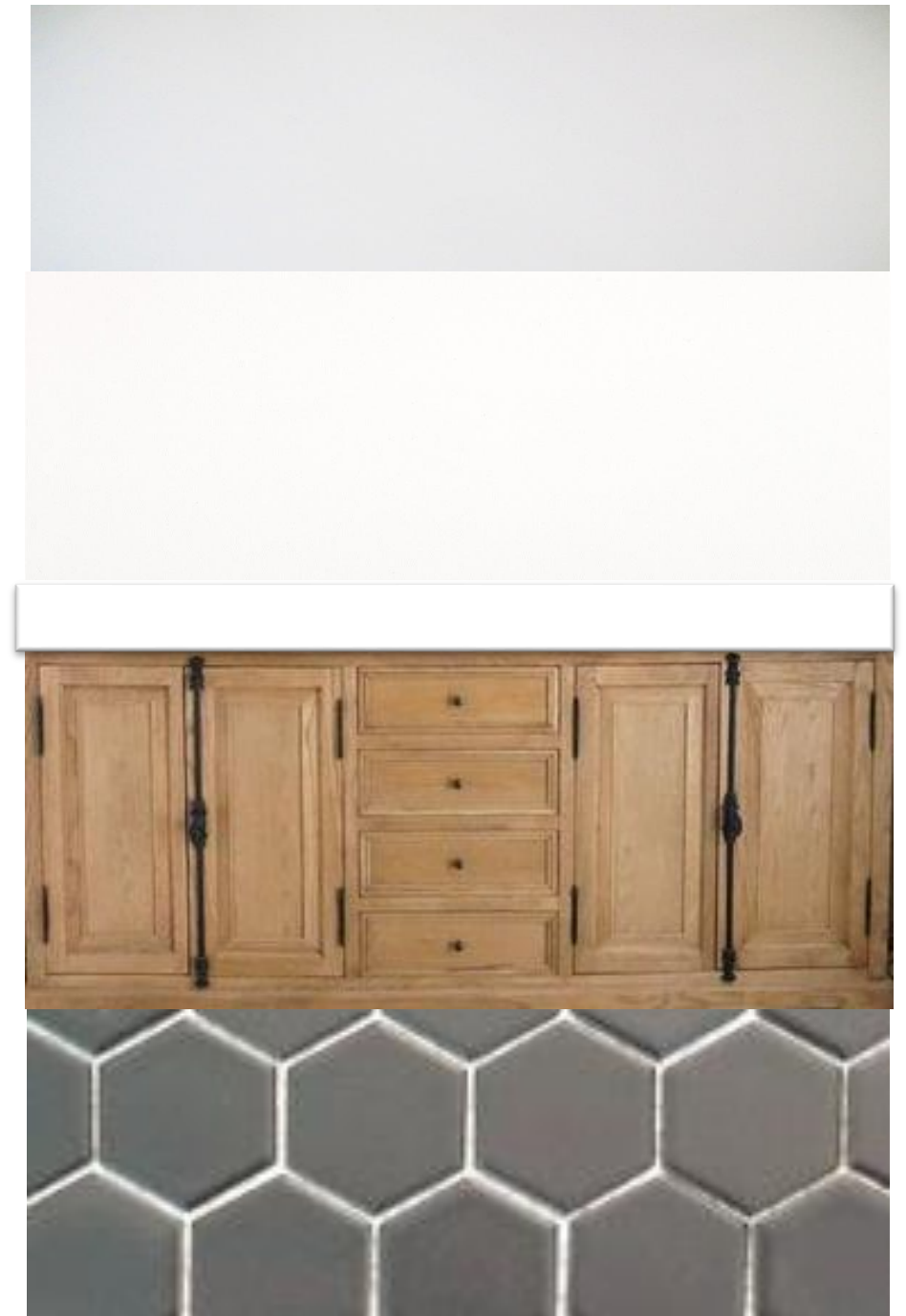

Finishes: Option 2

Living & Dining



Kitchen



Bathroom



Furniture Floor Plan

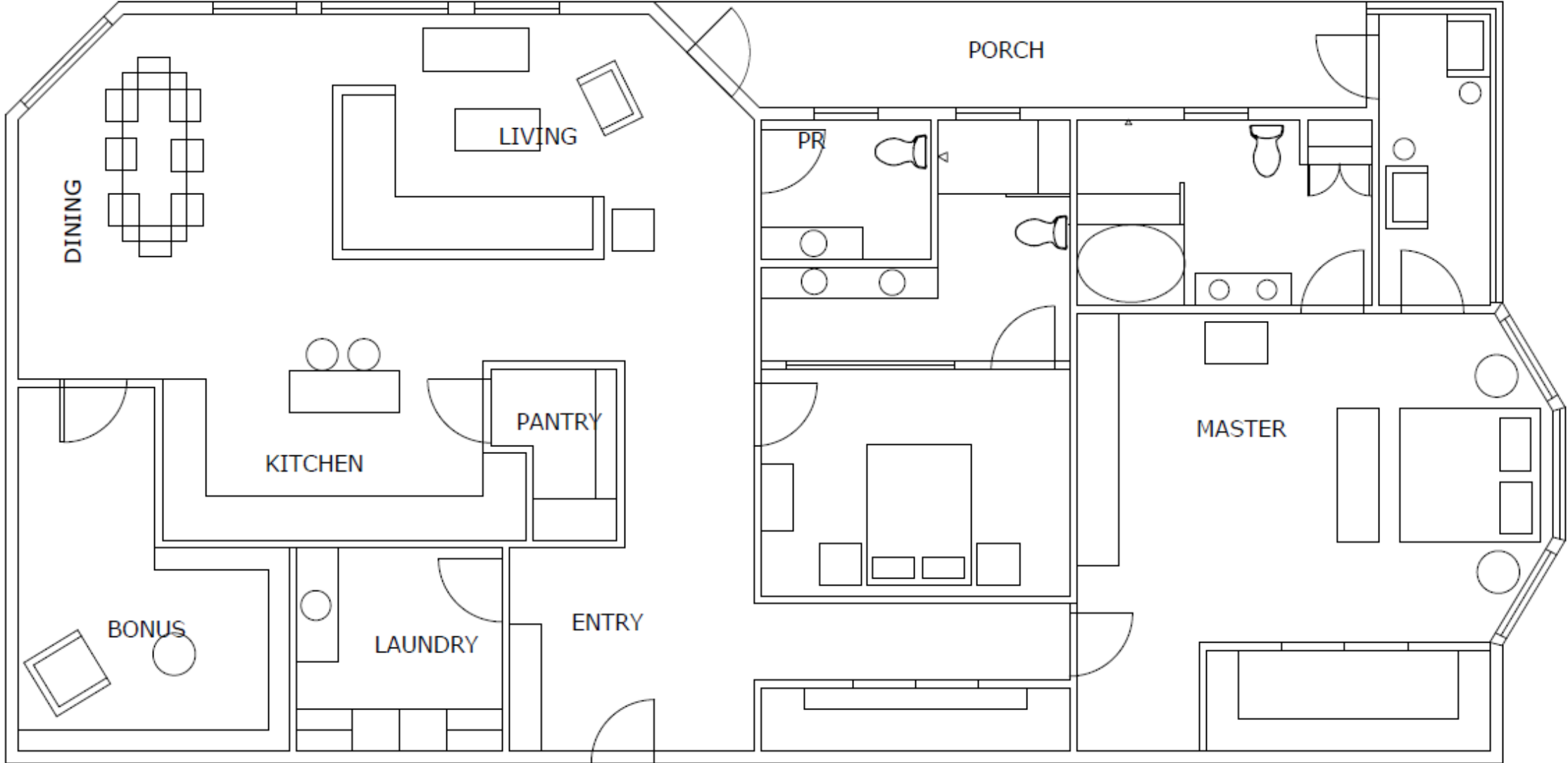

Not to Scale



Furniture Full Floor Plan

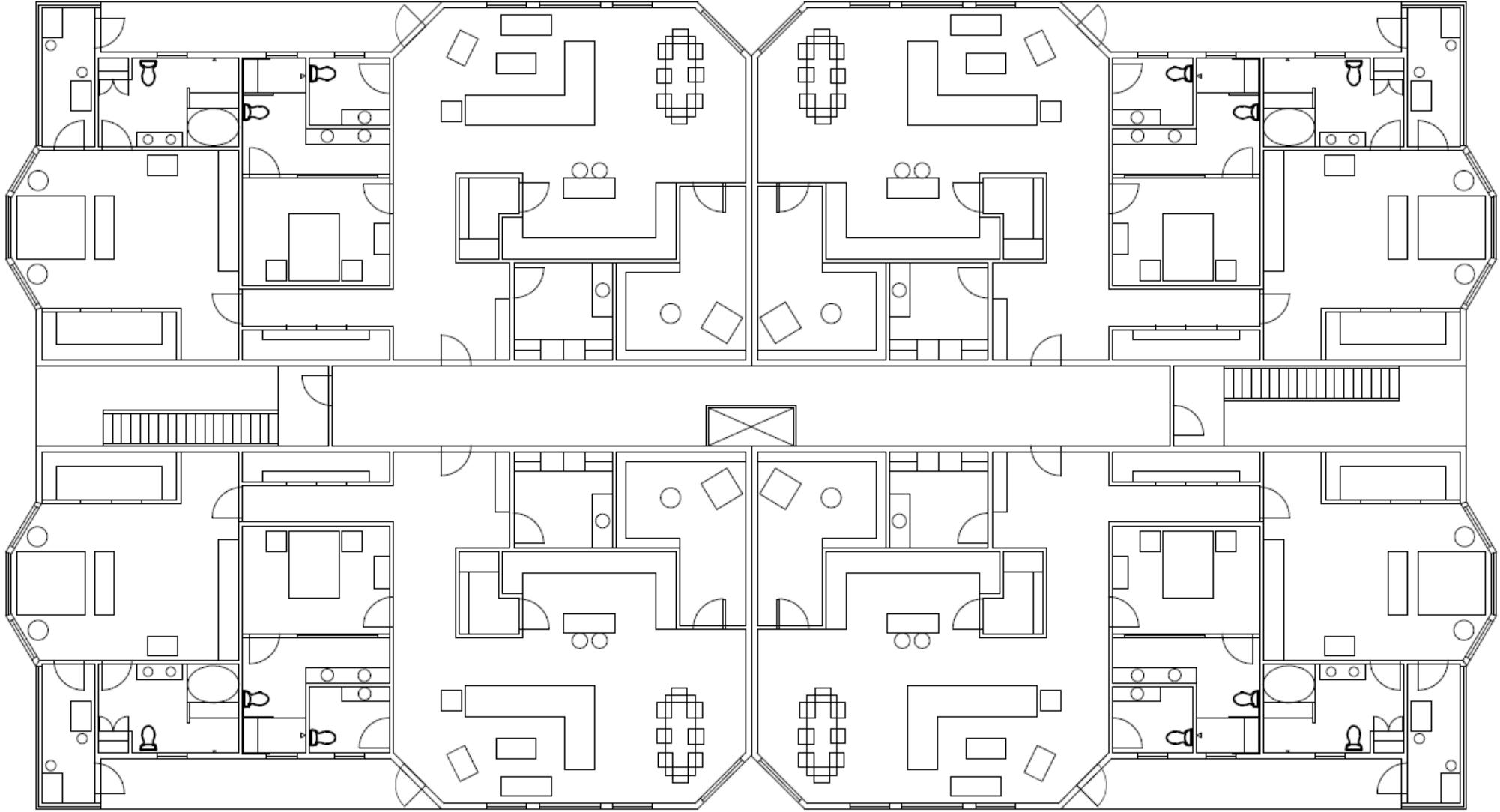

Not to Scale

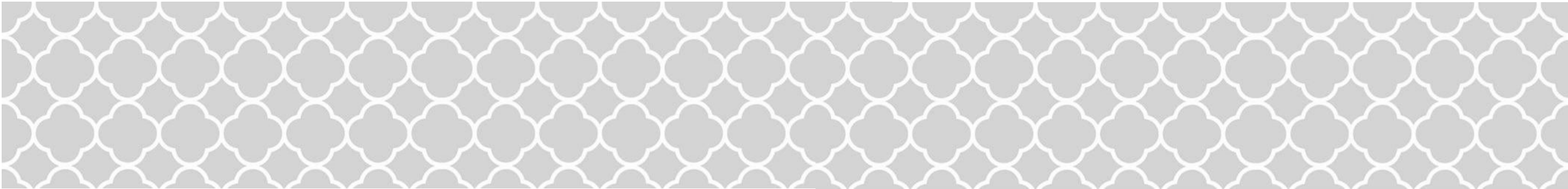

Elevations

13

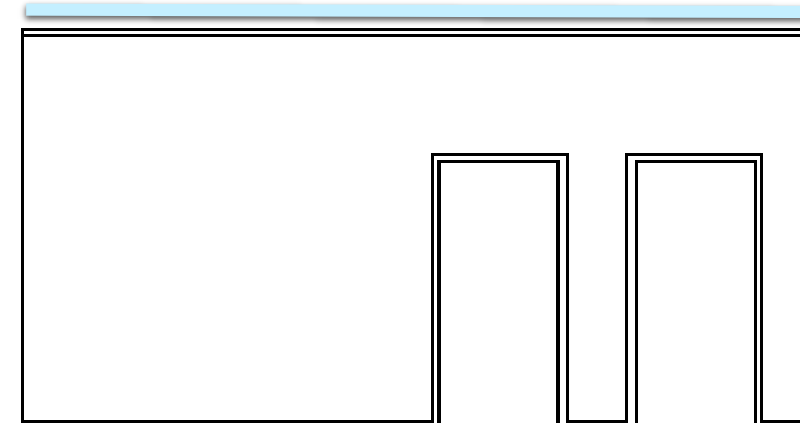
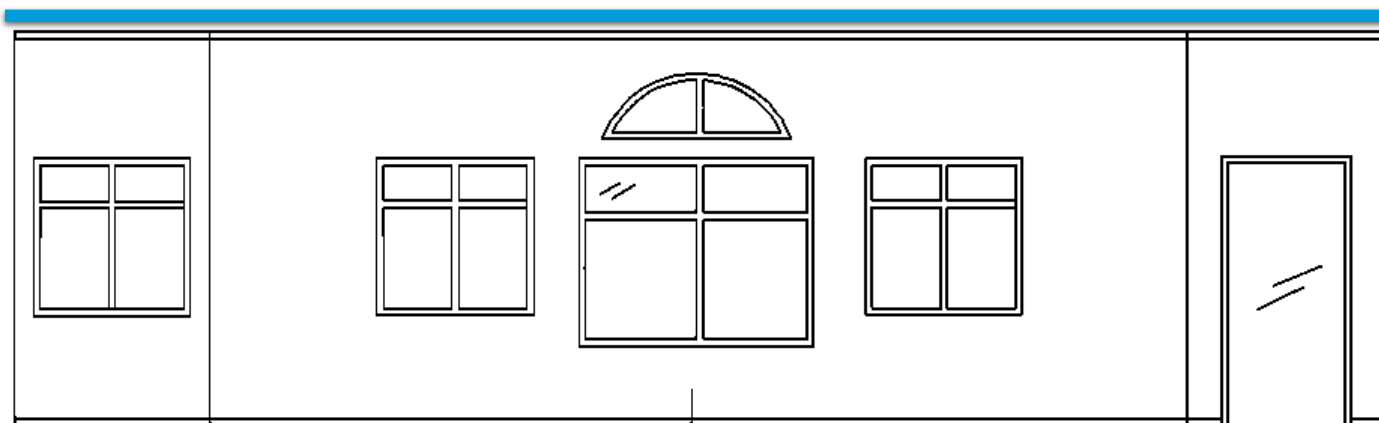
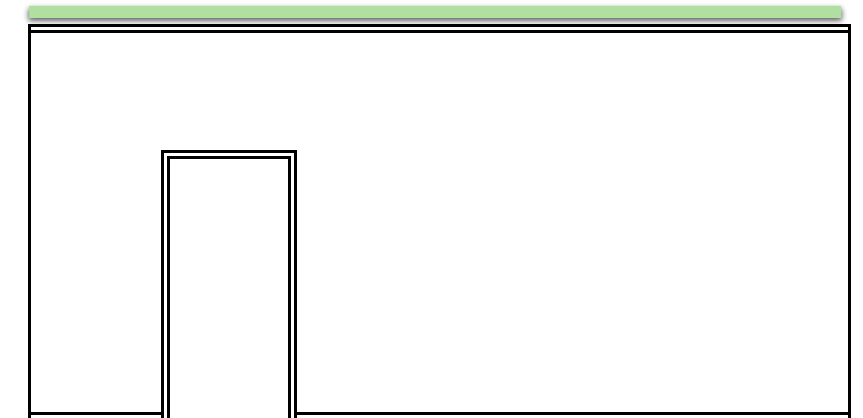
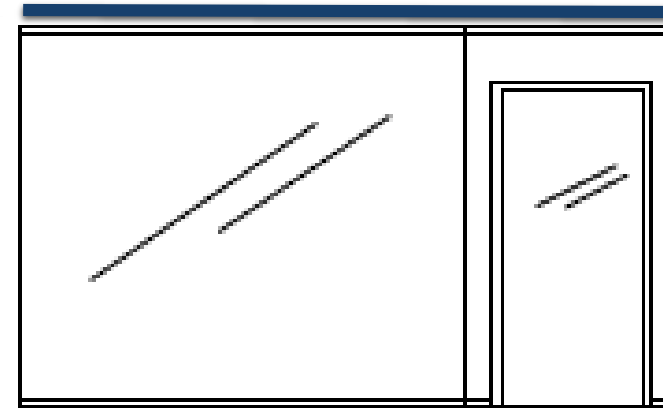
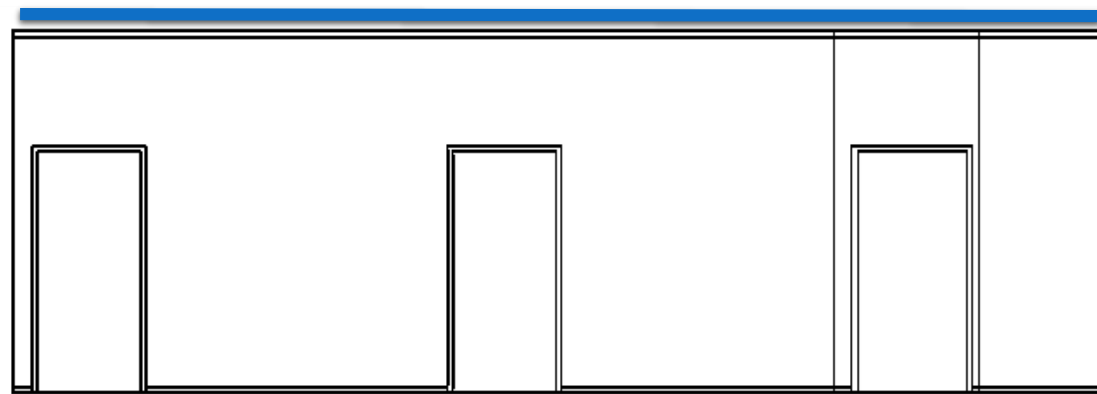
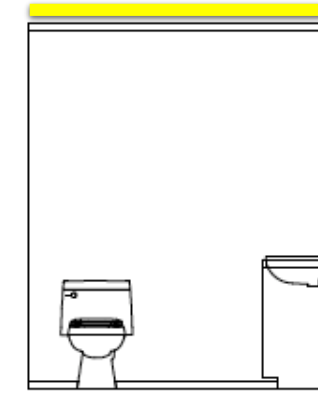
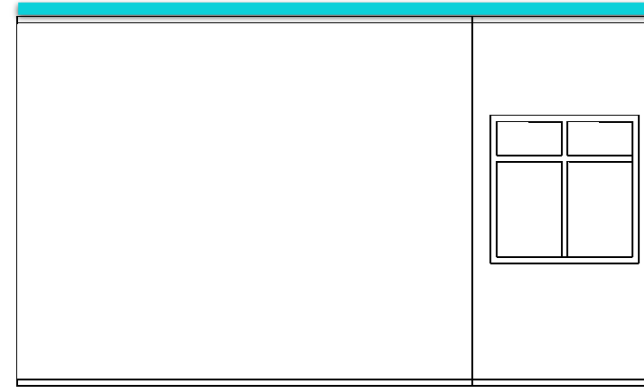
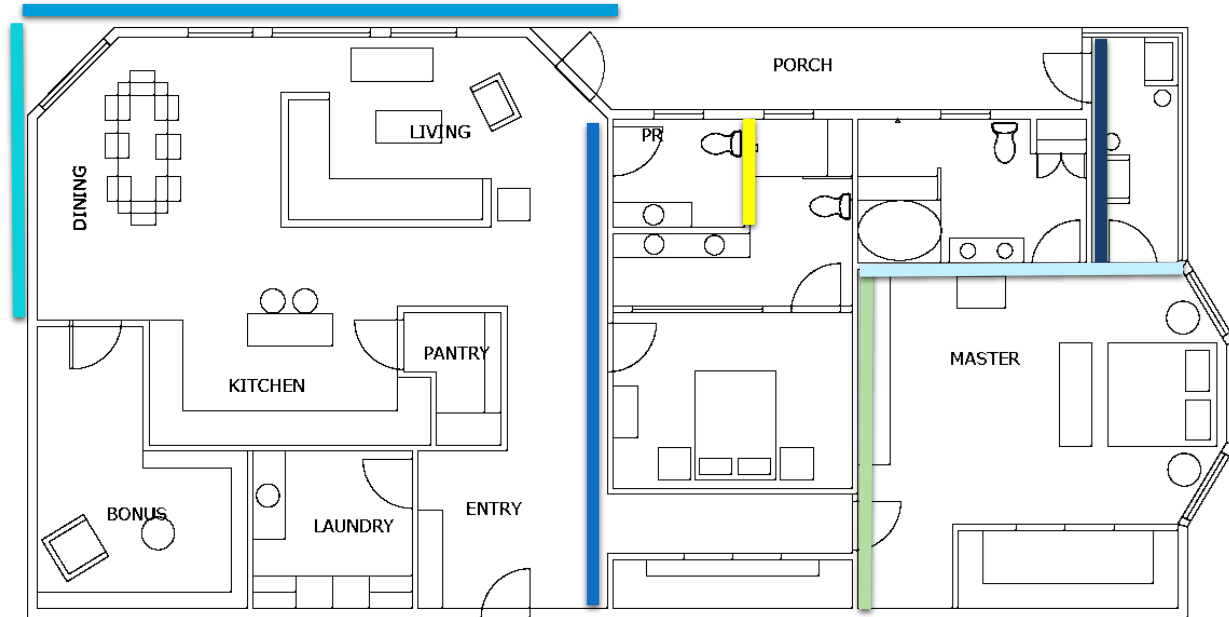

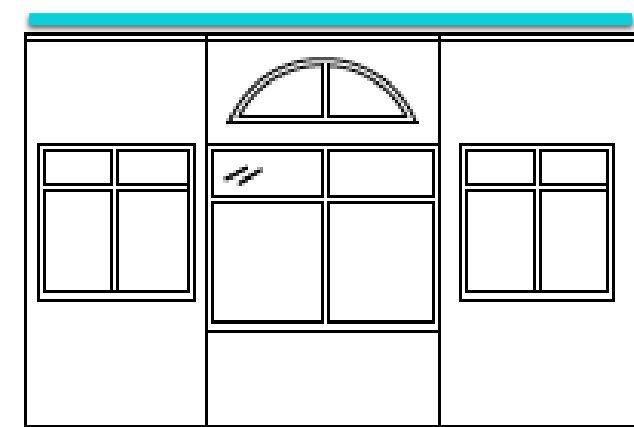
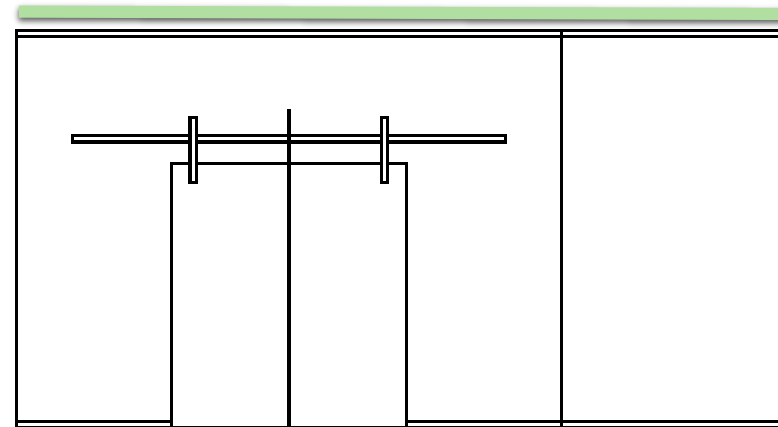
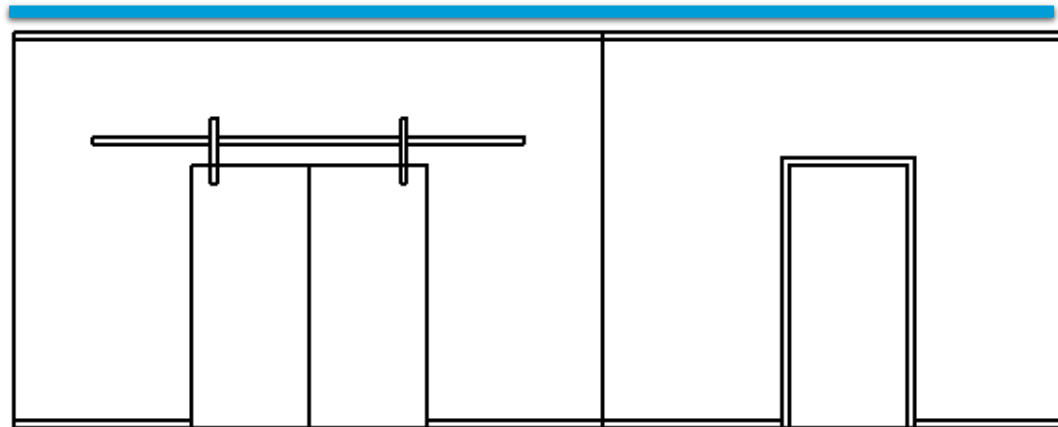
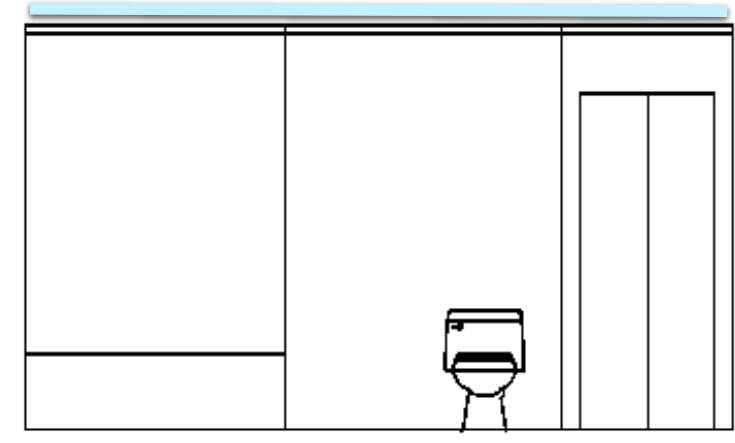
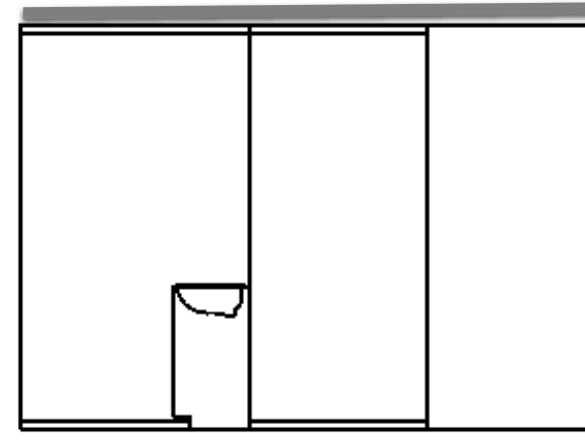
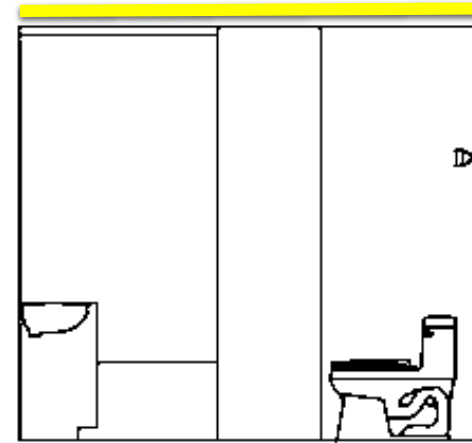
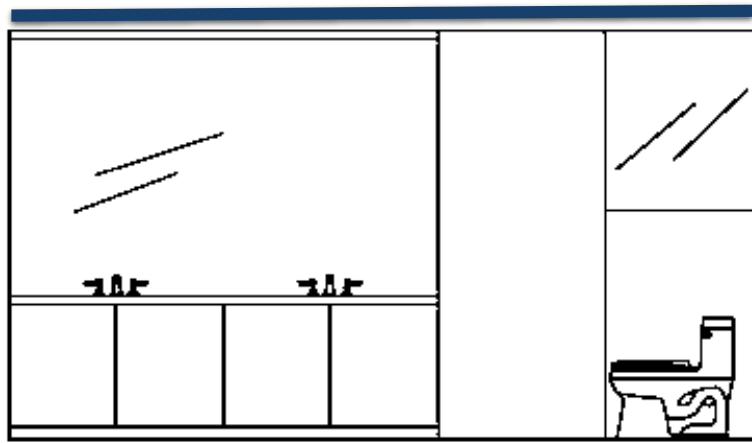
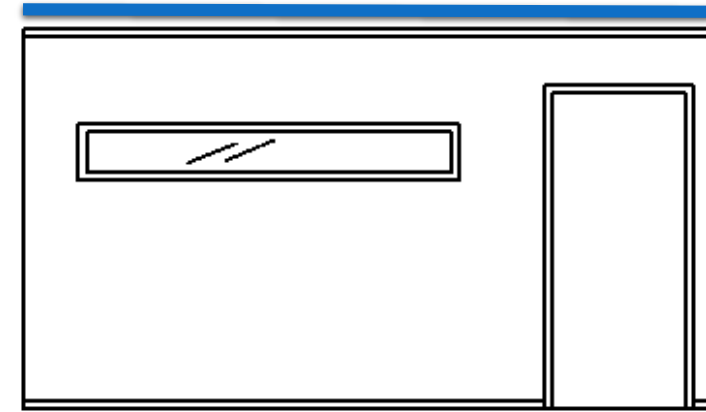
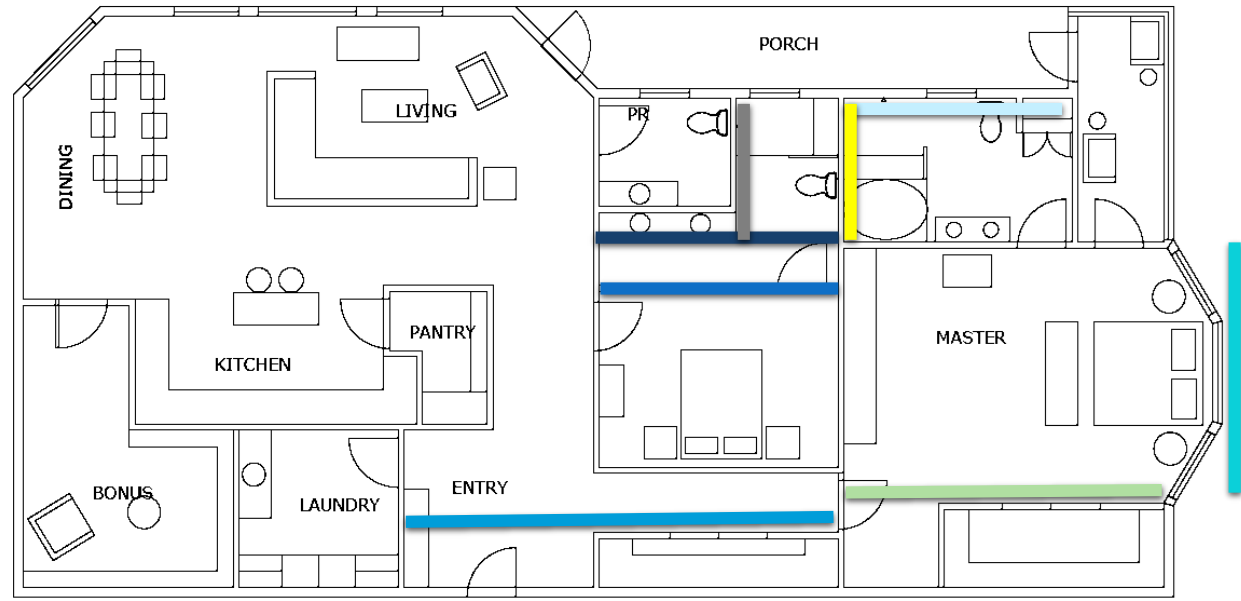

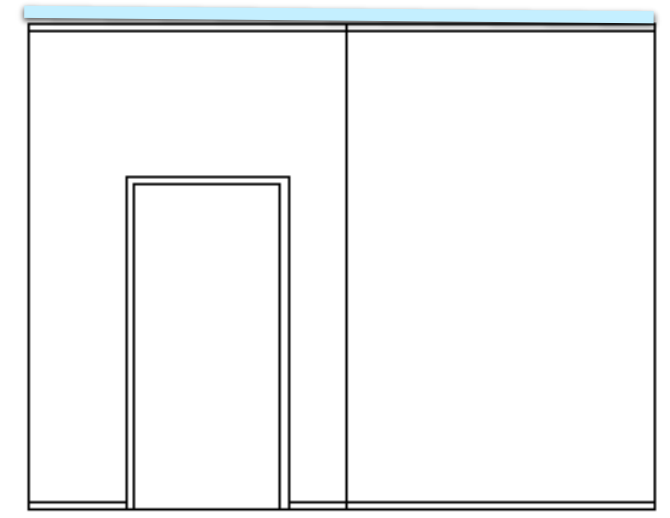
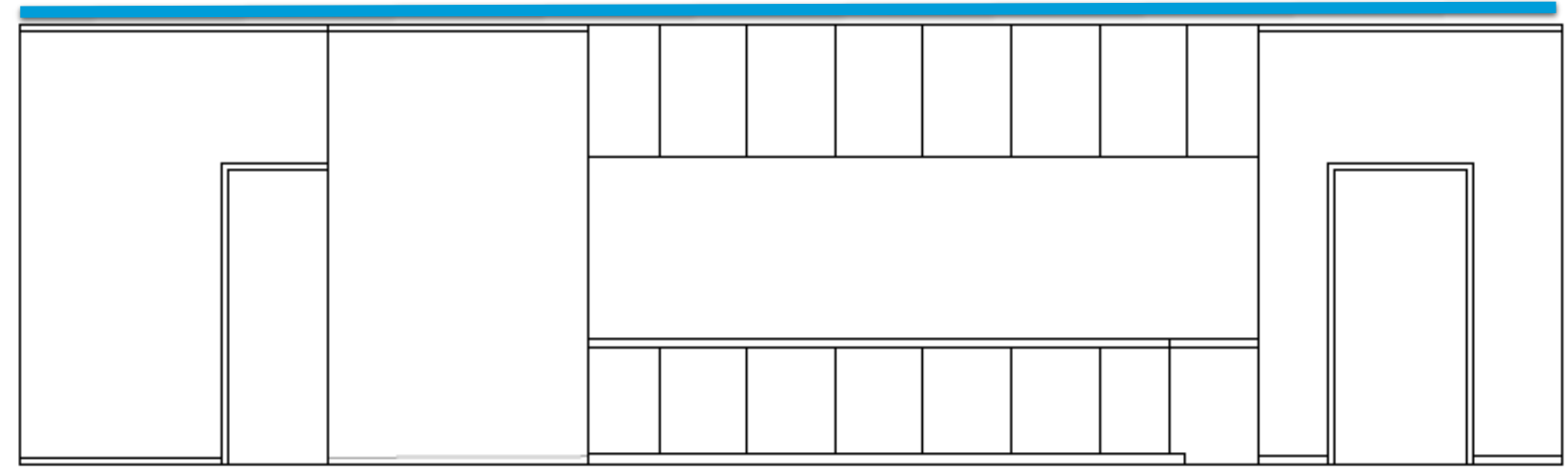
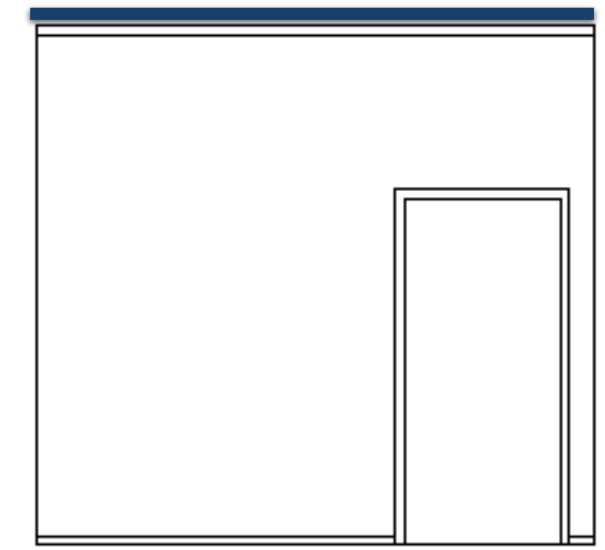
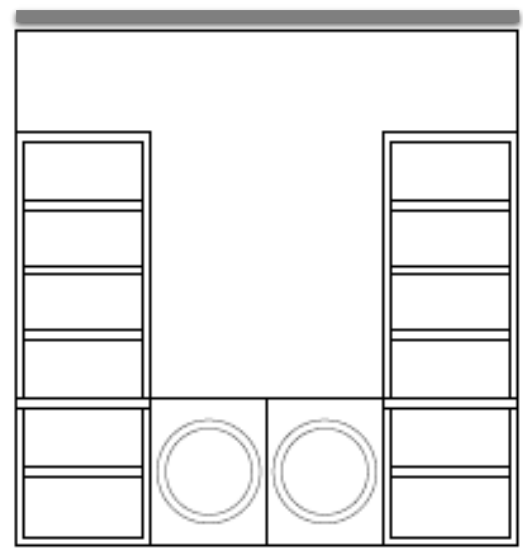
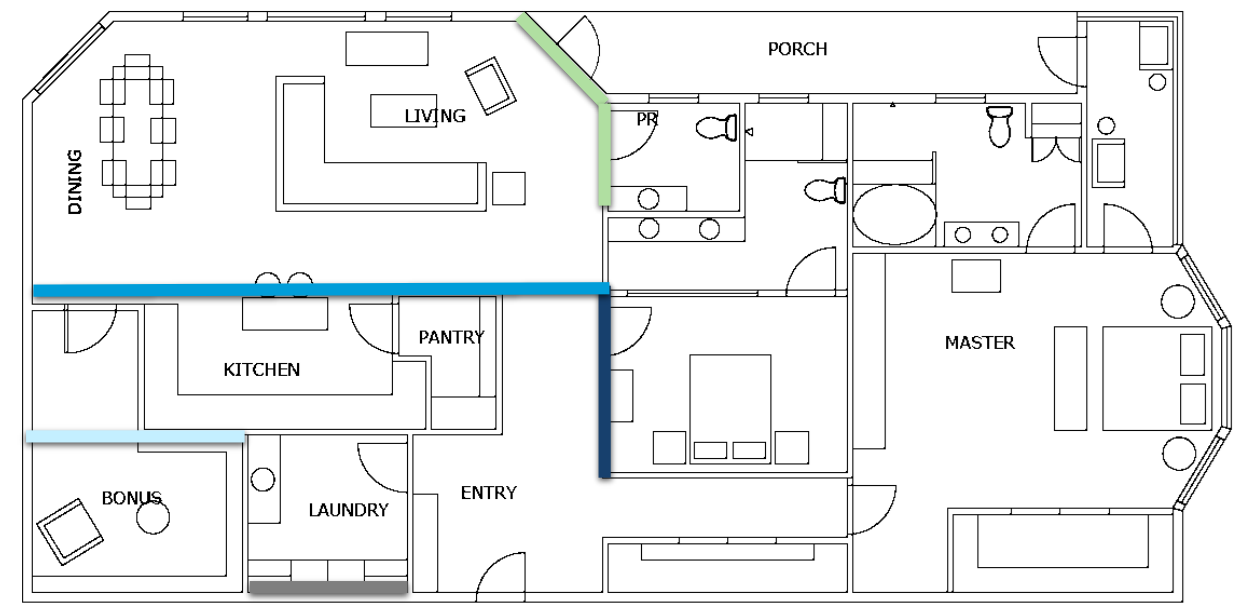

Exterior Massing

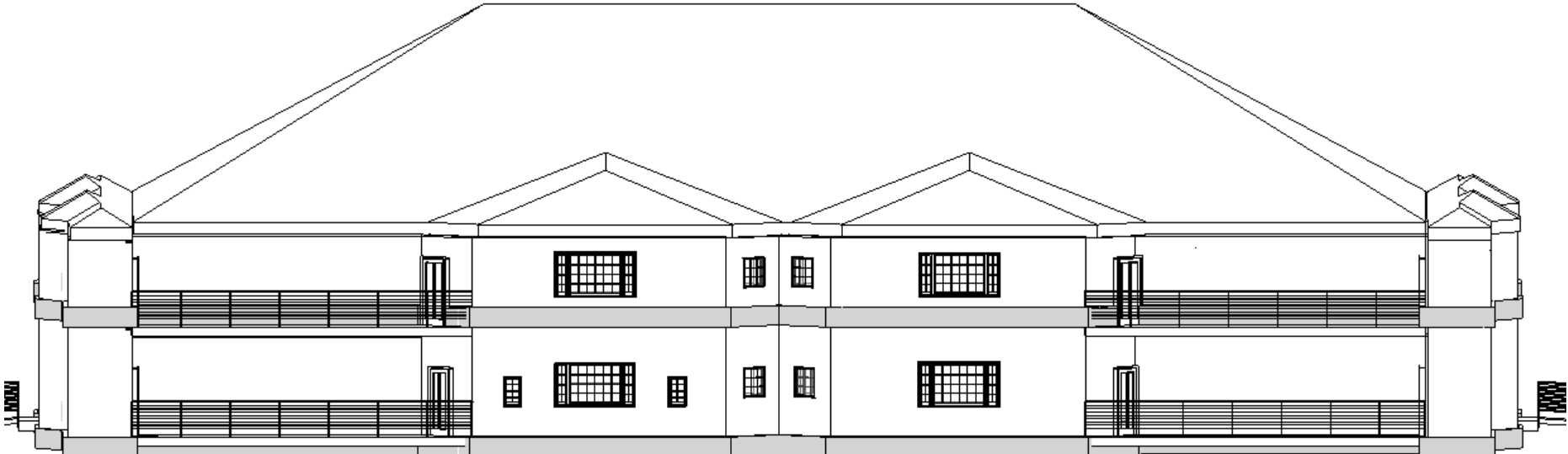
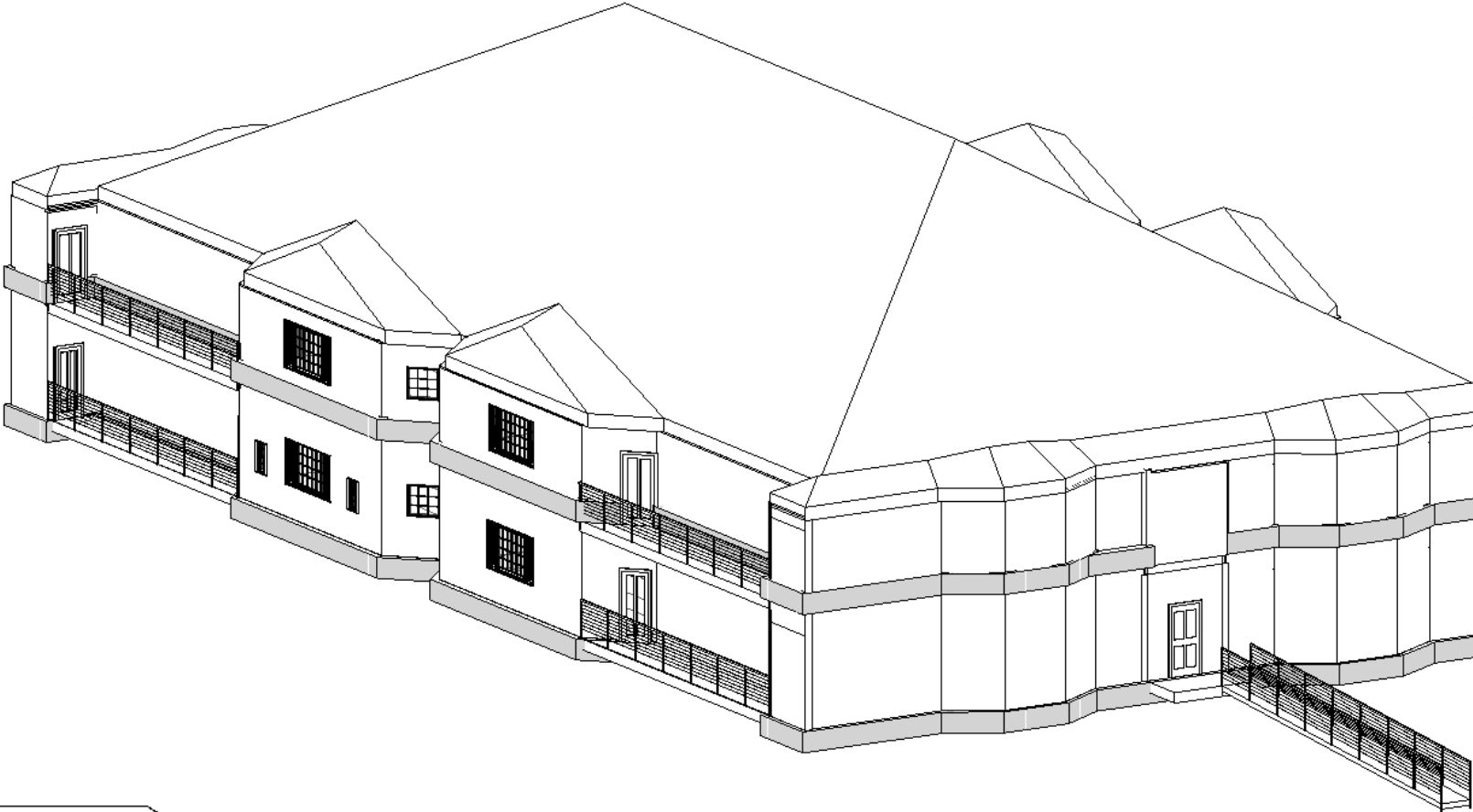
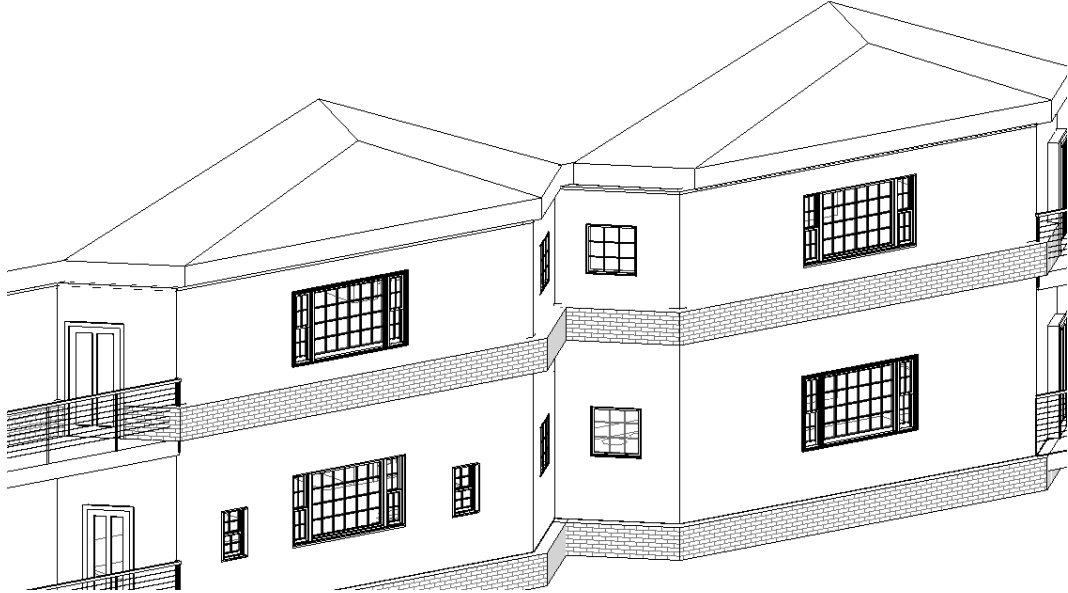

Central Building Section

17

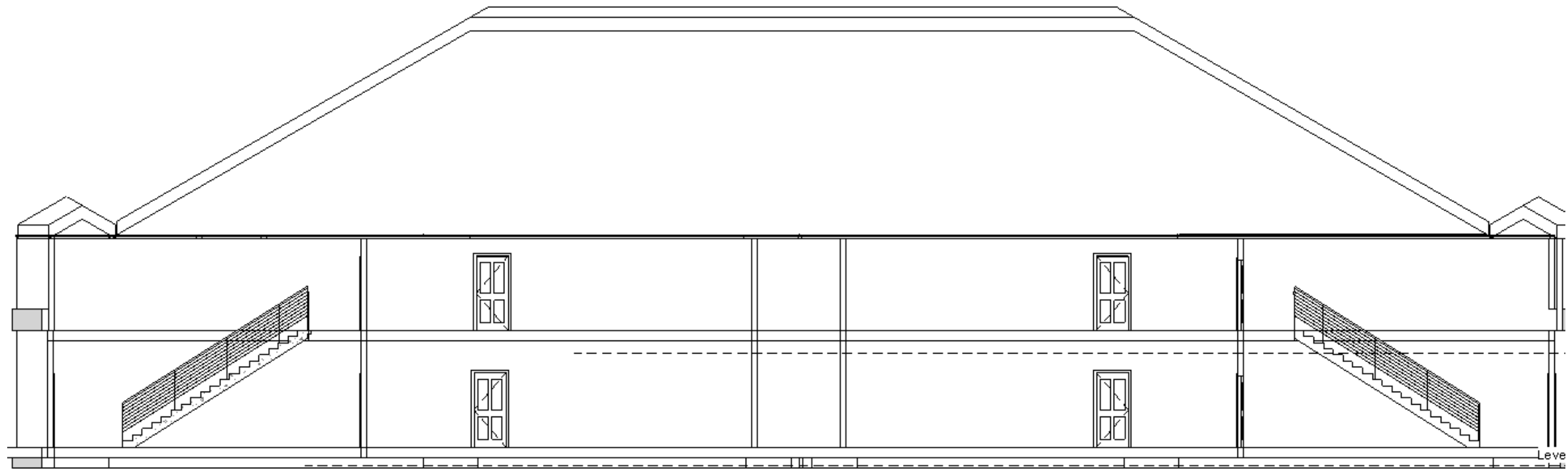

Accessible Design

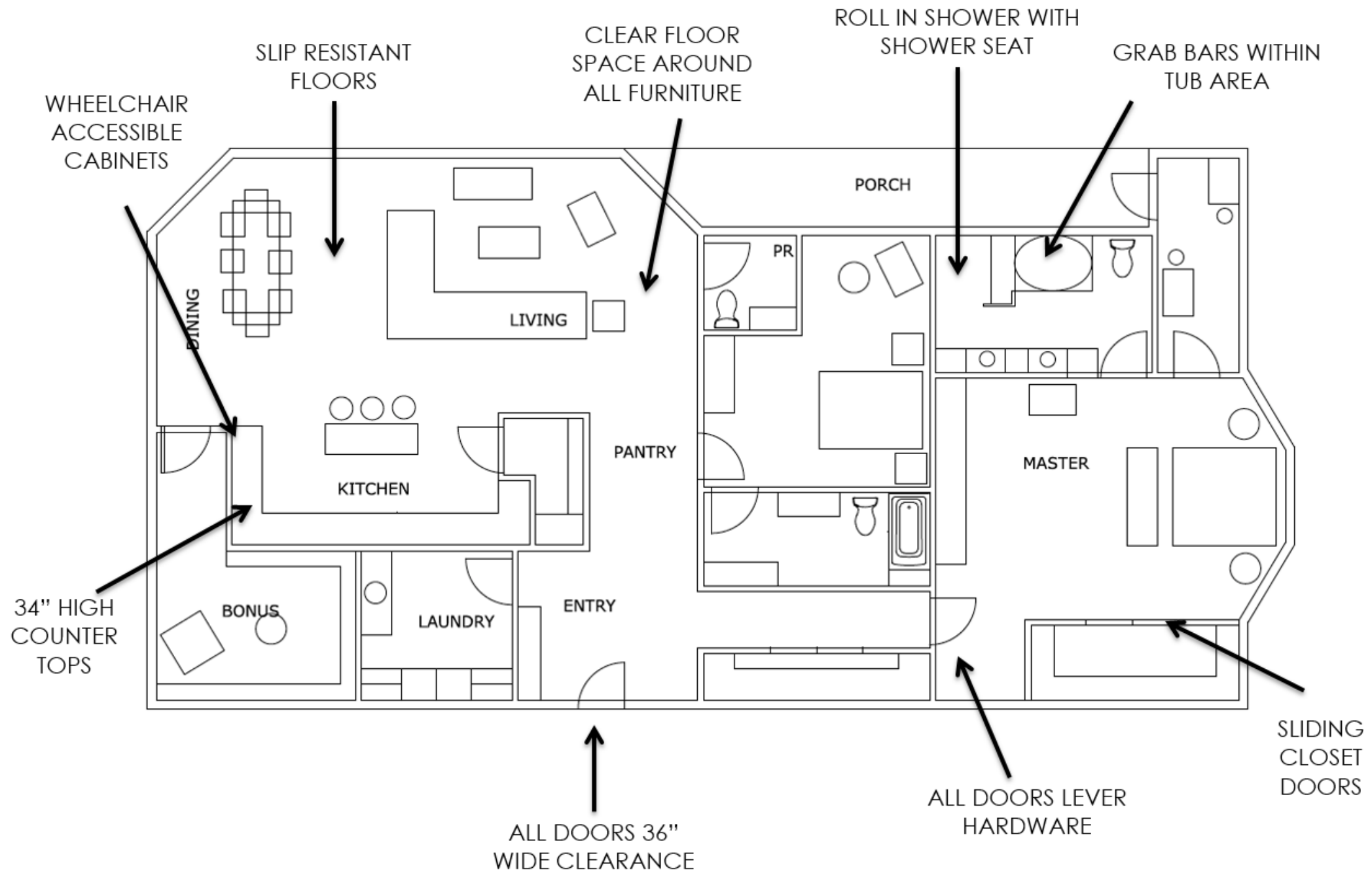

Perspectives

Kitchen, Living & Dining

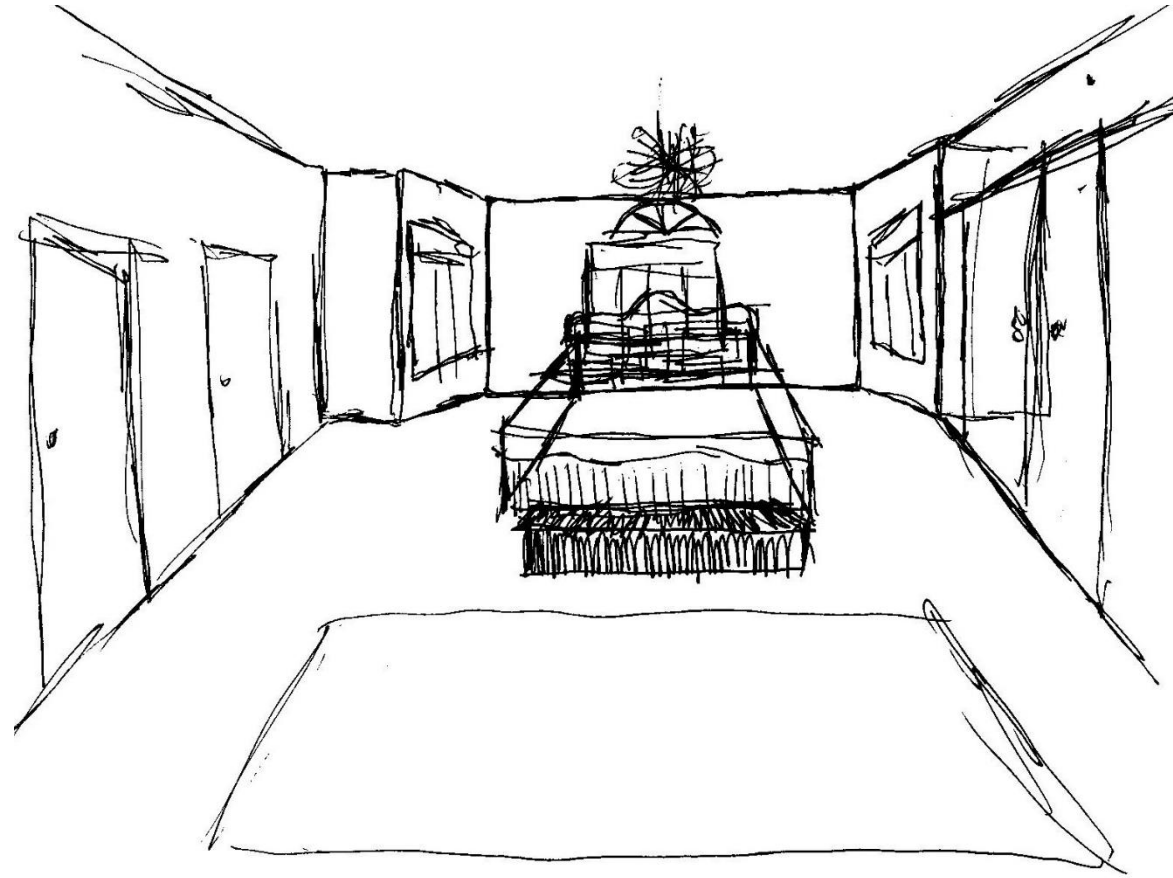
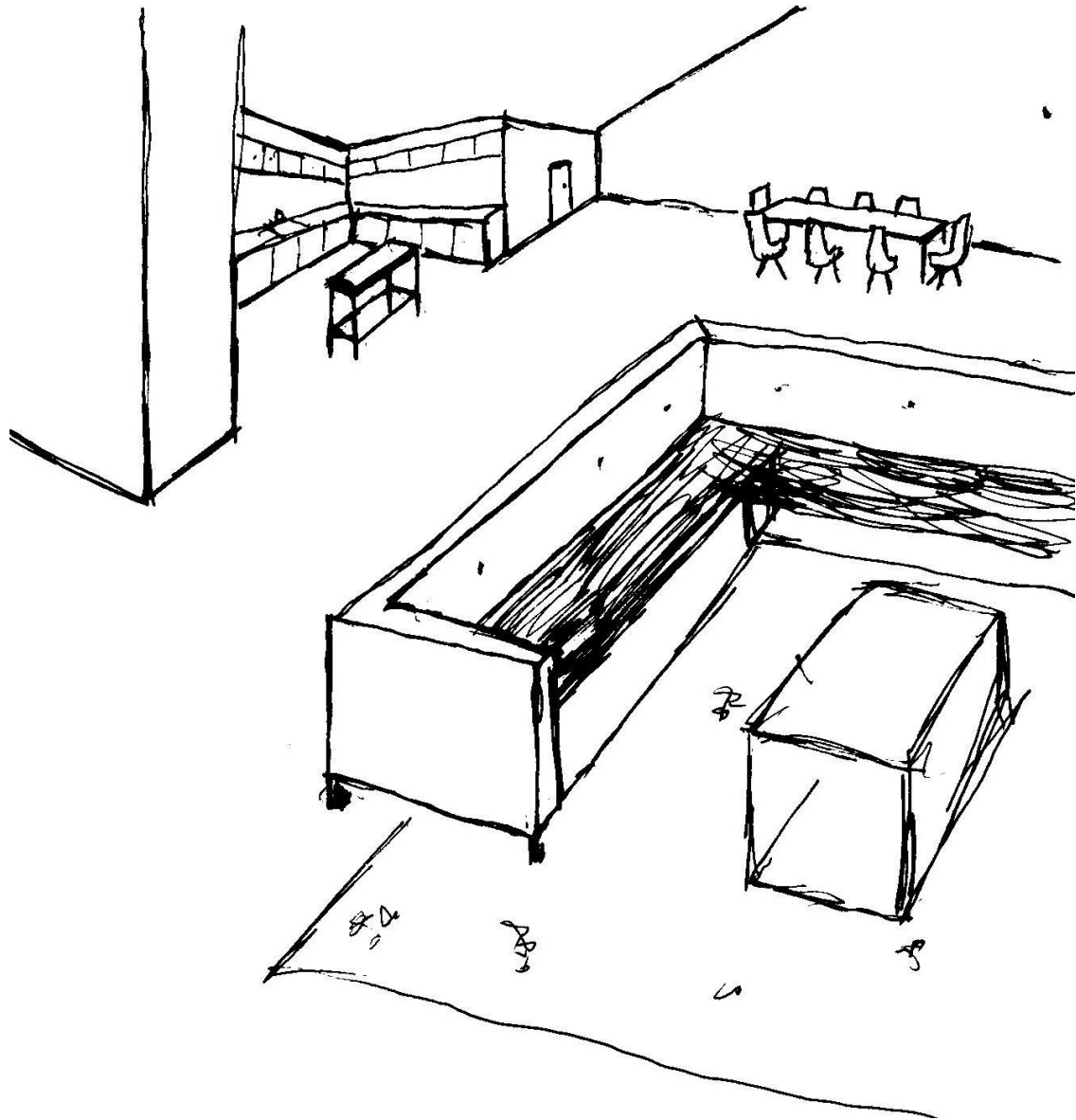

Master
Bedroom

Kitchen
& Dining

