

Portfolio 3

Emma Florez

IDSN - 3102

Fall 2019

Final Furniture Plan

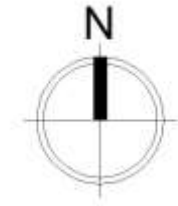

Reflected Ceiling Plan

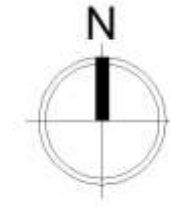

Rendered Perspective- Living Room



Rendered Perspective-Master



Rendered Perspective- Entry



Color Rationale

- Provide a fresh, inviting, relaxing green atmosphere
- Calm color scheme



Back to Nature, Light Drizzle, Secret Meadow, blue bird, and Dragonfly

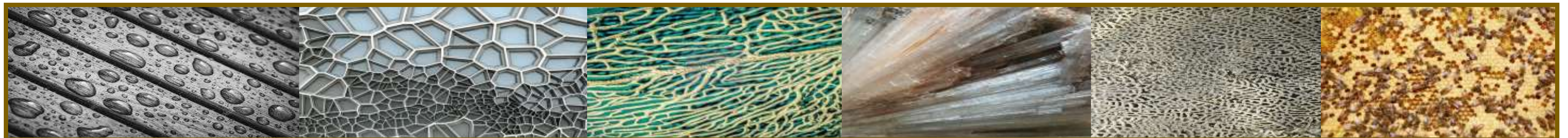

Furniture and Finishes- Living

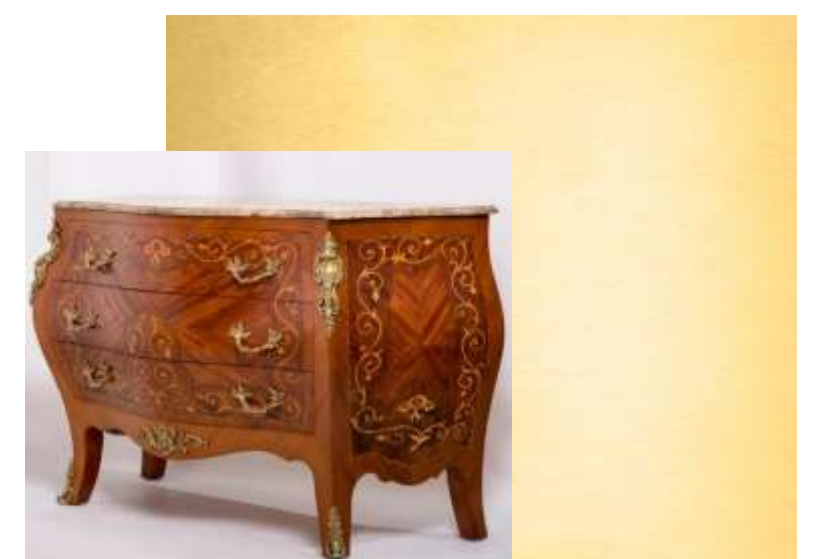

Furniture and Finishes- Living



Furniture and Finishes- Master



Furniture and Finishes- Master



Furniture and Finishes-Entry

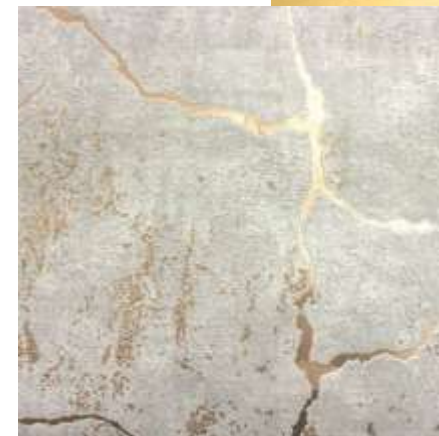

Furniture and Finishes-Entry



Anthropometric and Ergonomic

Handicap Accessible Spaces

Furniture and usable space to keep good posture and blood flow in order to create comfortable design in a functional living space

Higher Seating with firmer cushions to be able to get up easier

32" ADA writing surfaces

5' wheel chair turn radius

30" min knee space at sinks, countertops, ranges

34" max height for countertops

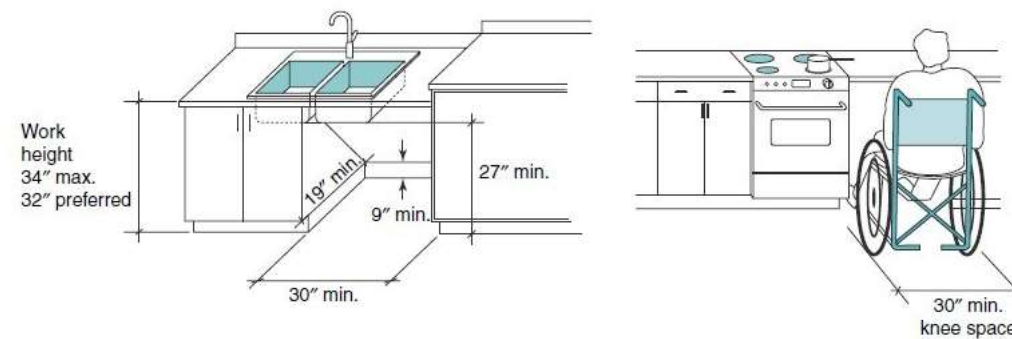
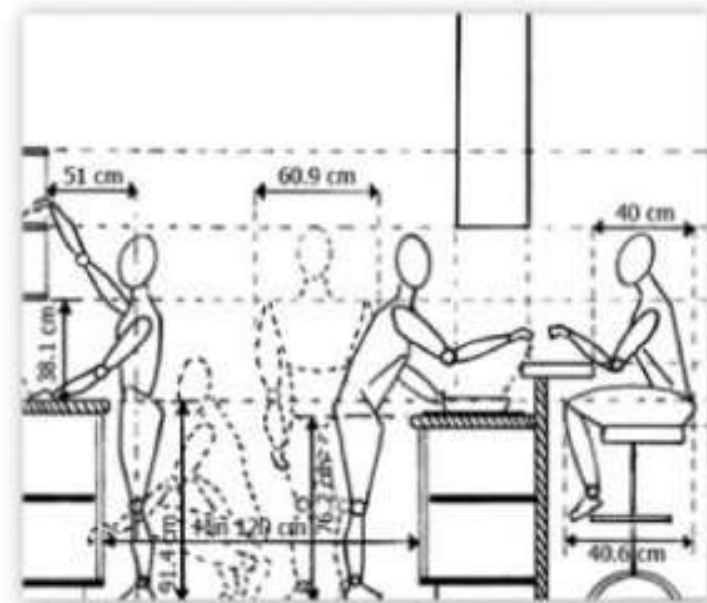

Fig 1



Fig 2

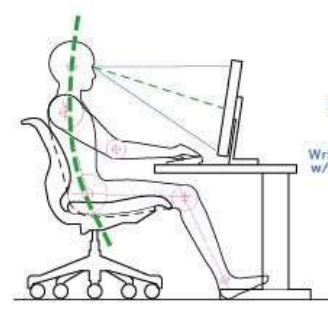
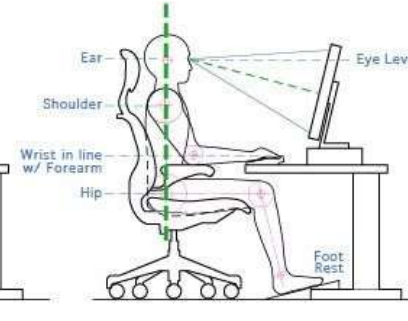
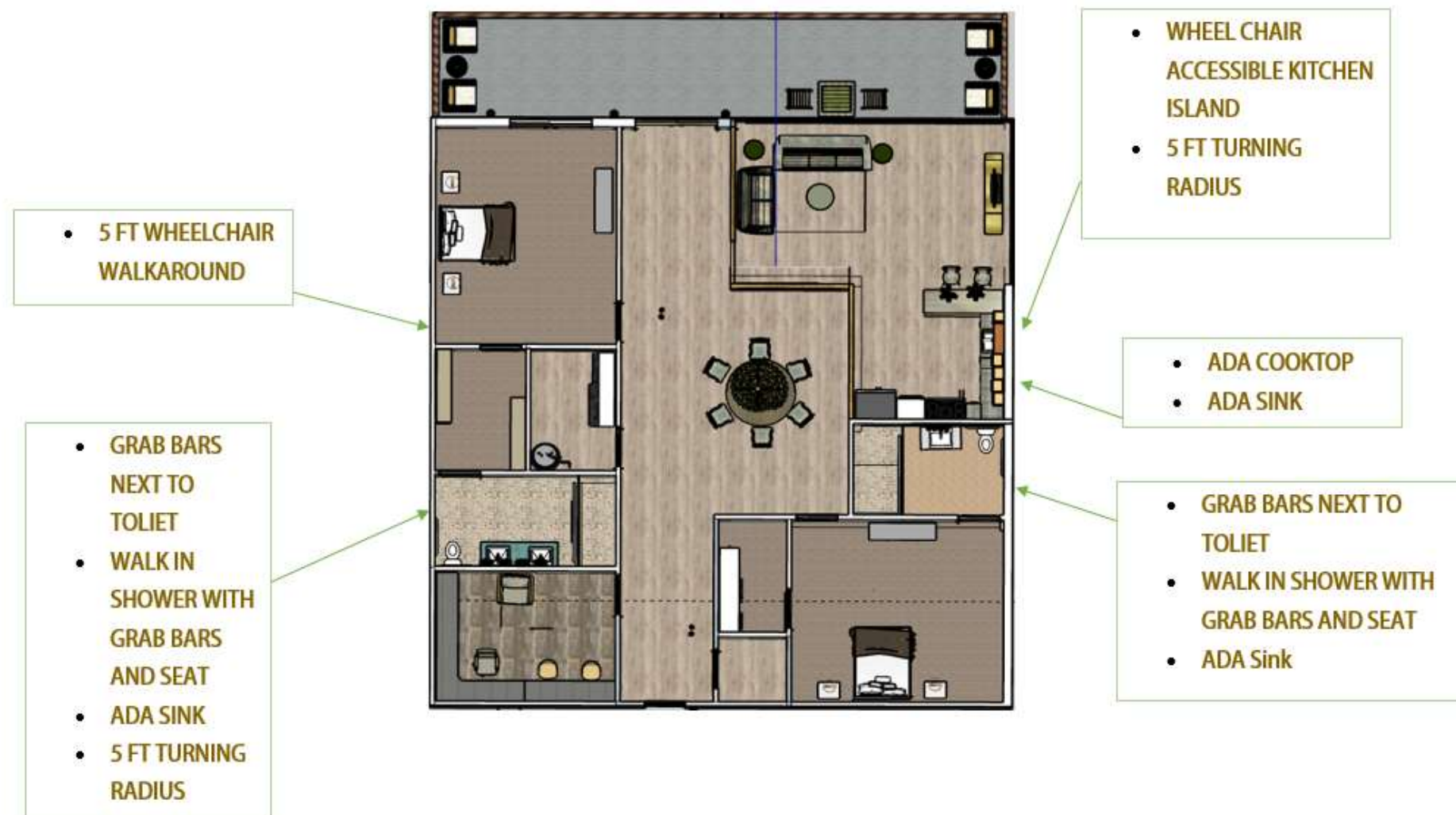

Fig 3



Inspired by Nature

Bring Natural Elements into the Design. Create a stress free, healthy, happy, sustainable, functional living environment. Using Line to emphasize the design elements through the formatting of nature. Incorporate elements of nature into the design by using the inspiration of nature.



Video Walkthrough

<https://vimeo.com/374706355>