

Lowery-3201-2

---

Tyana Lowery

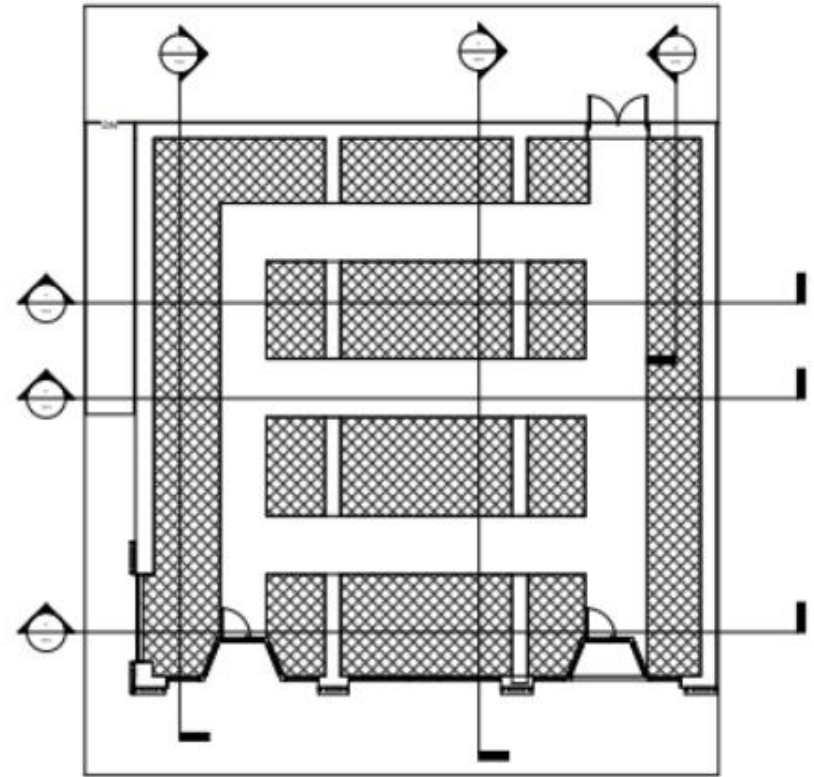
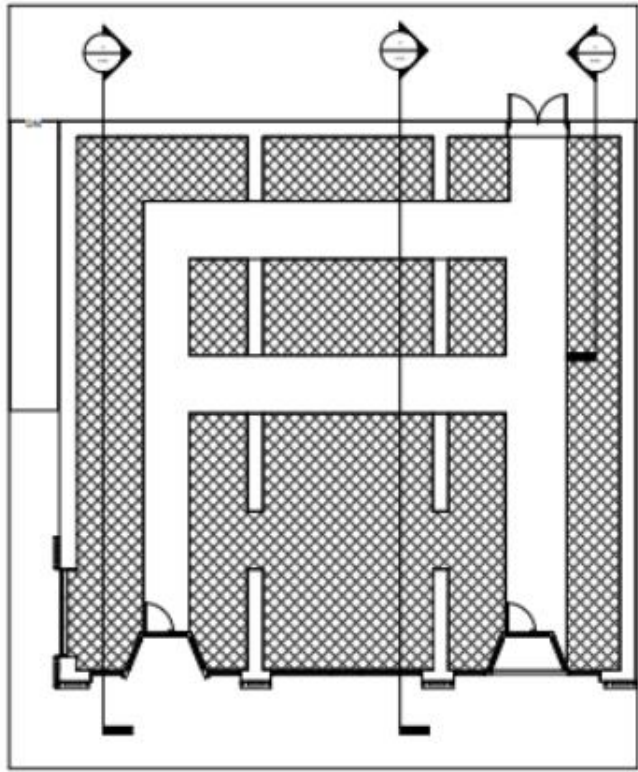

# Circulation Plans

---

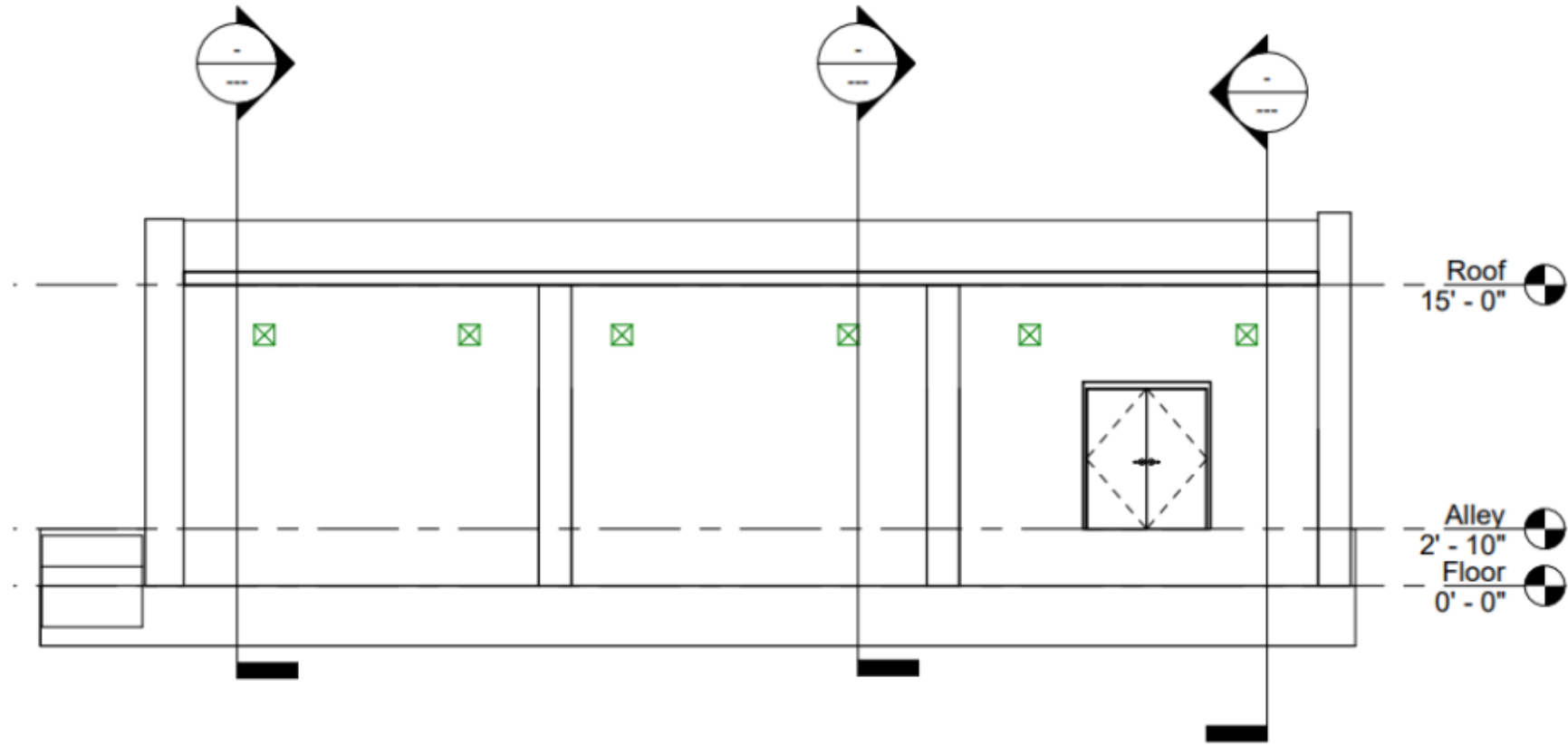

# Ductwork Locations

---



# Space Plan Sketches

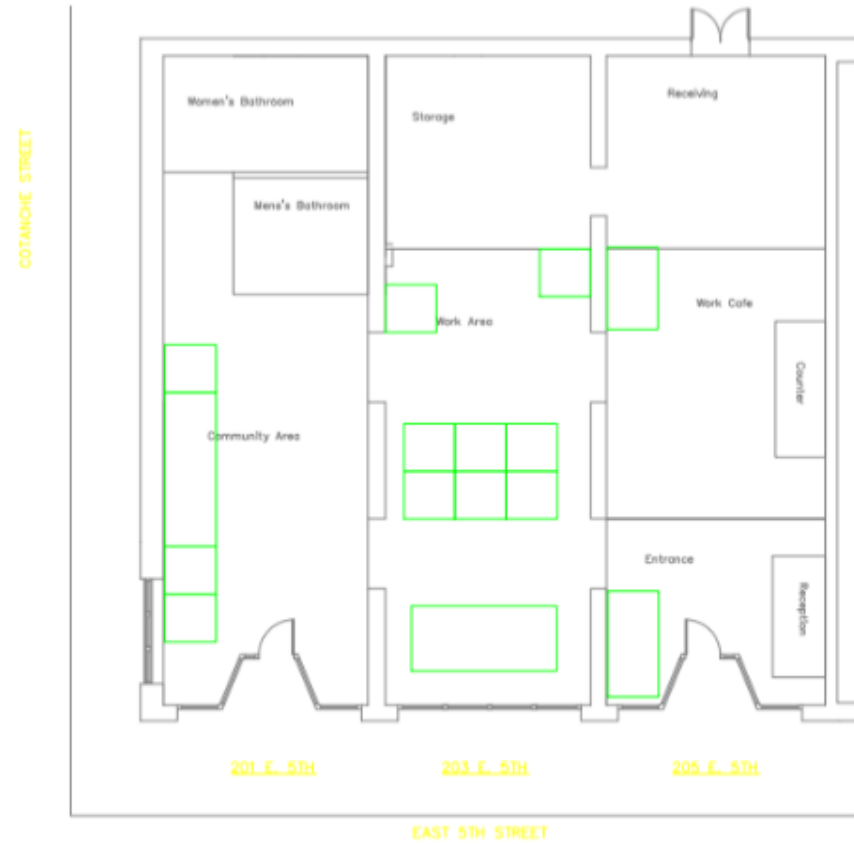
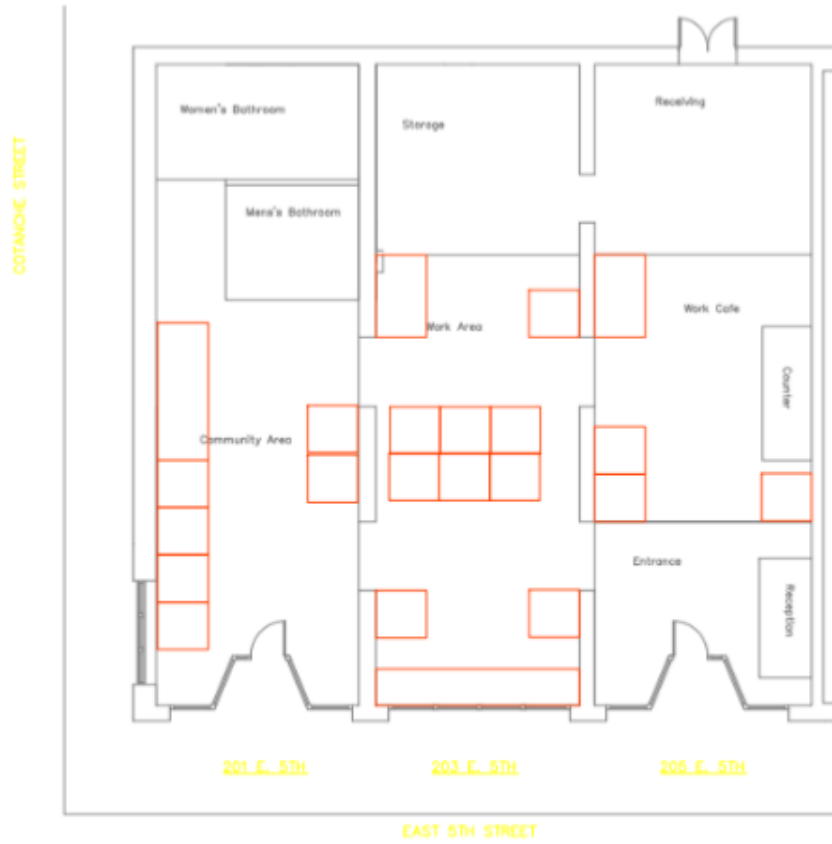

# Space Plan Sketches

# Hand Sketches

---

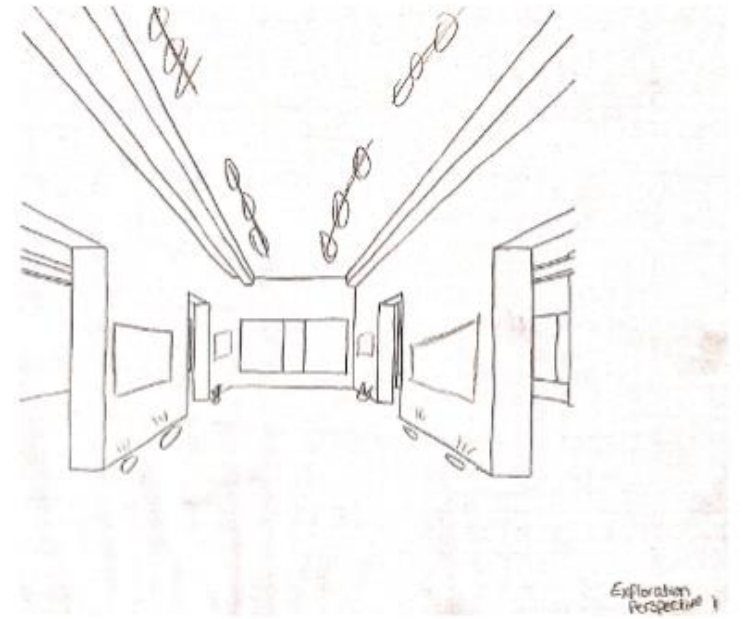
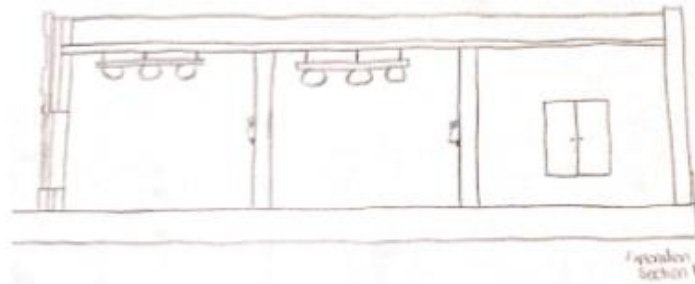
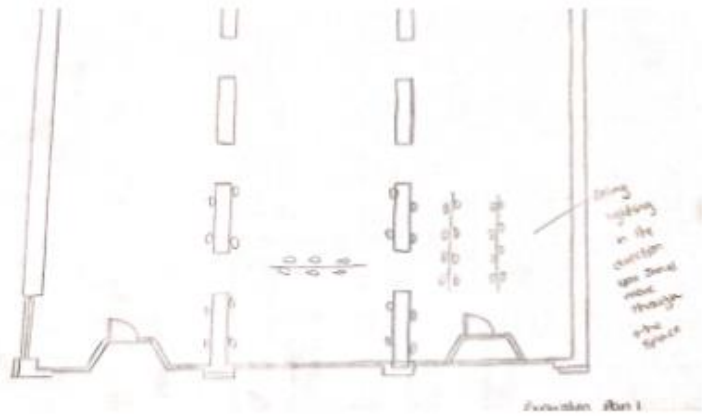

# Problem Resolution Studies - Exploration 1

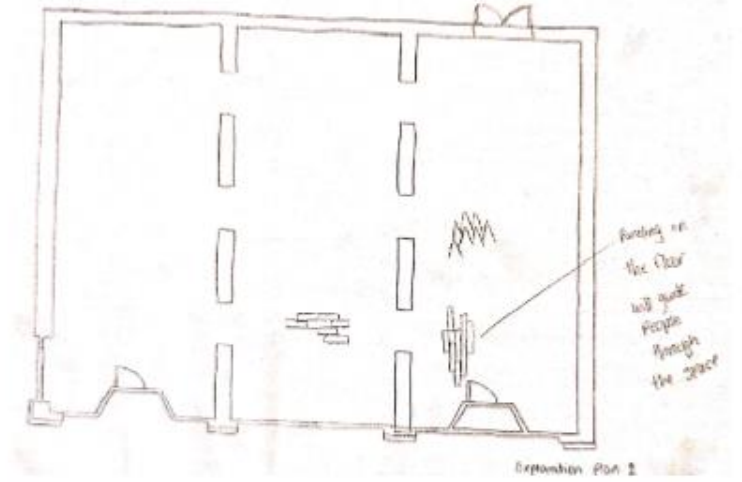
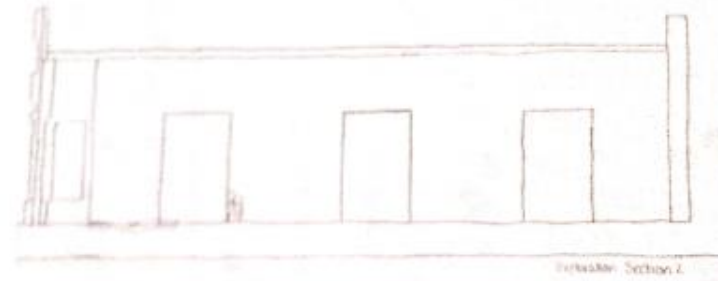
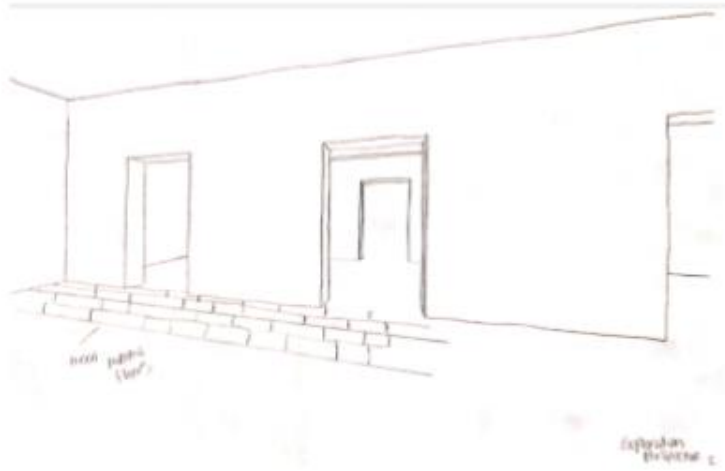

# Problem Resolution Studies- Exploration 2



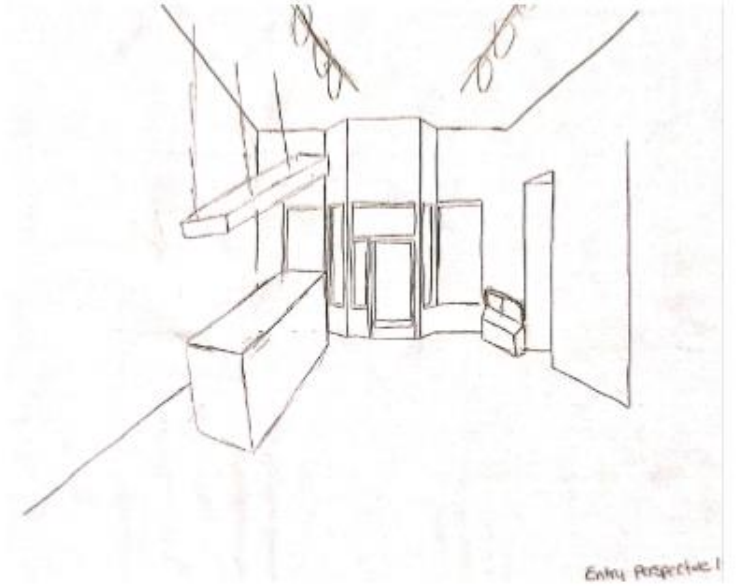
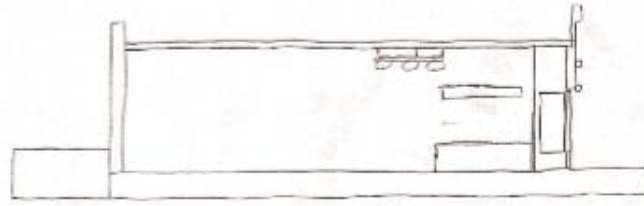
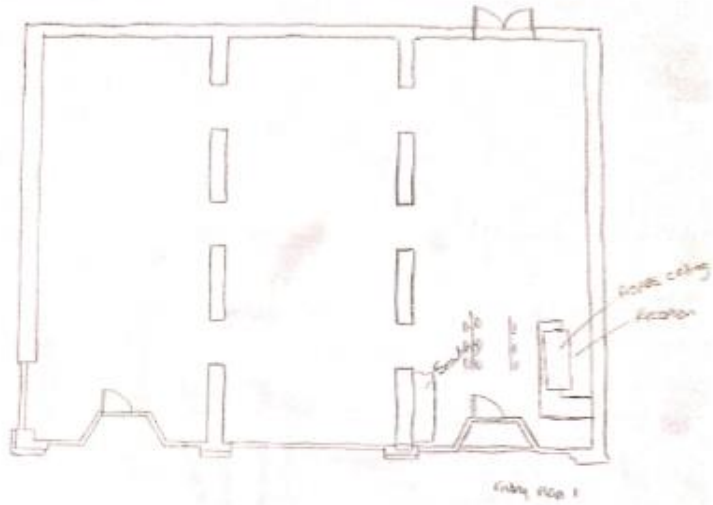

# Problem Resolution Studies - Entry 1

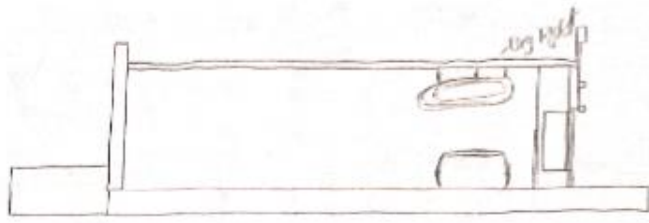

Entry Section 1

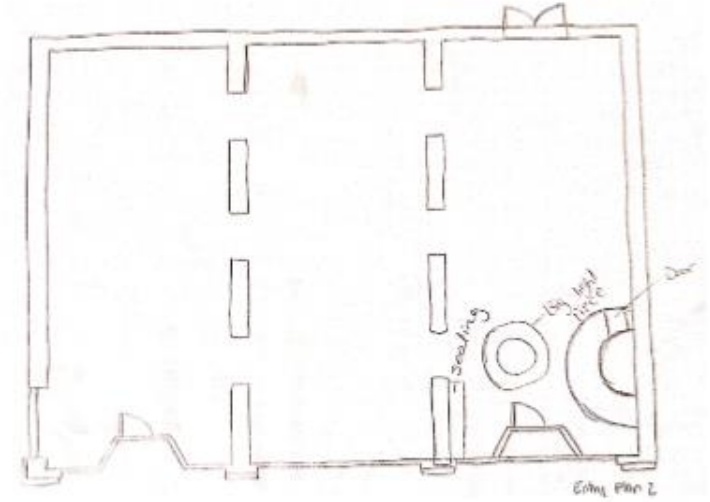
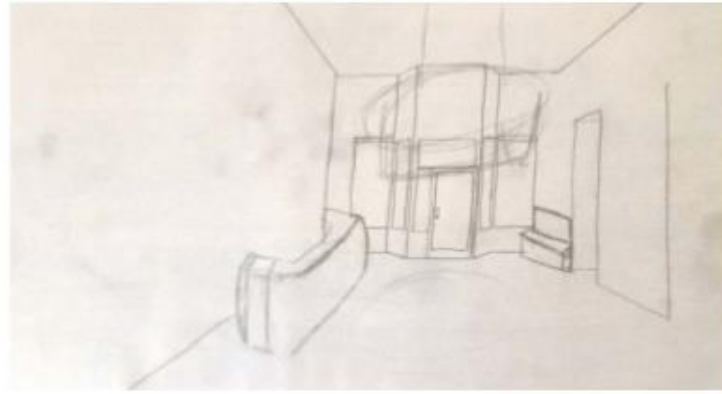

Entry Plan 2

# Problem Resolution Studies -Entry 2

---

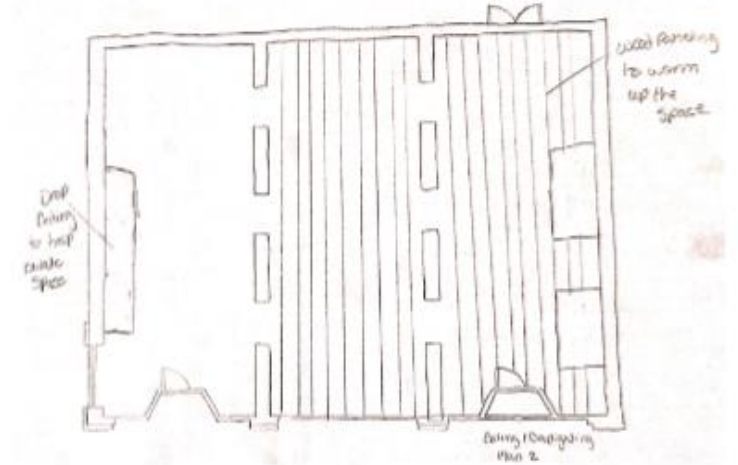
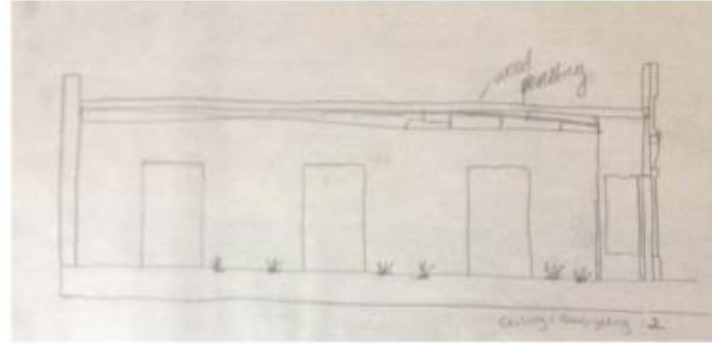
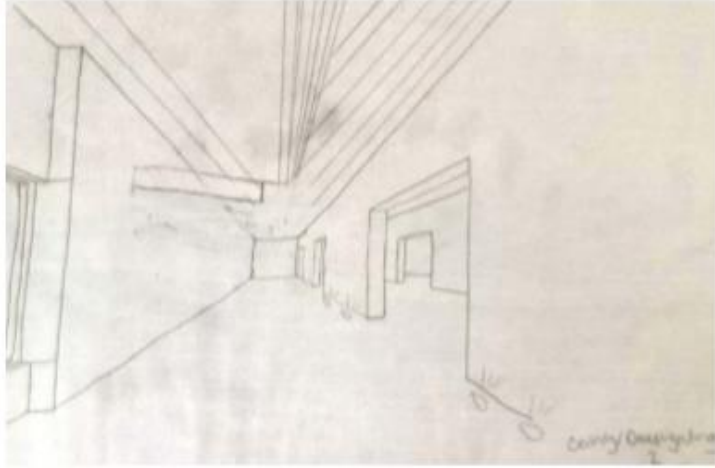

# Problem Resolution Studies -Ceiling/Daylighting 1

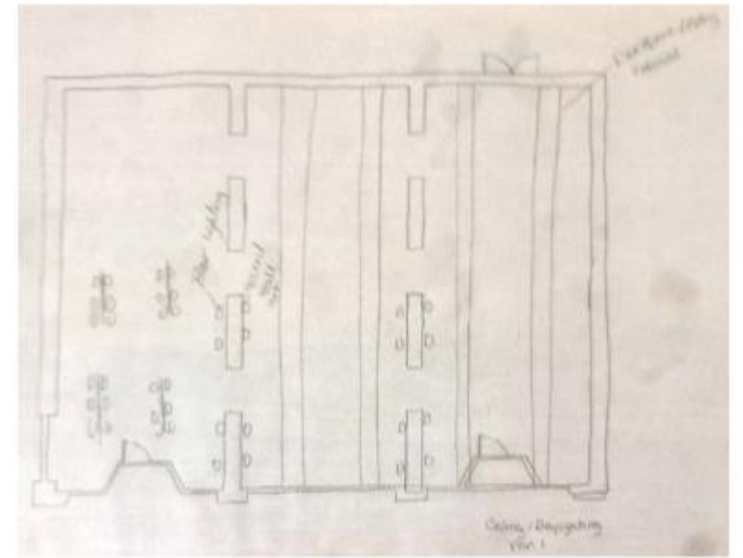
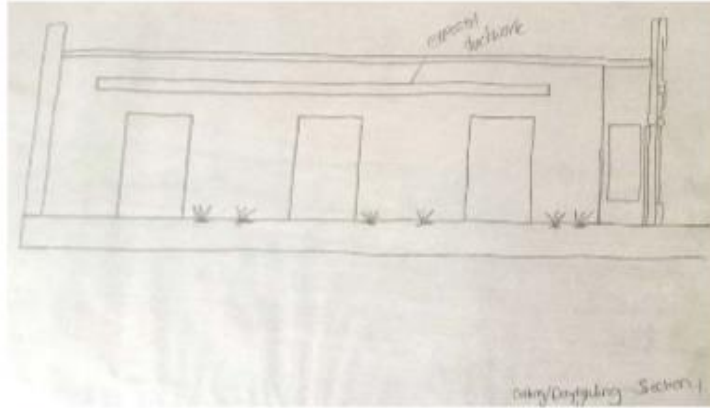
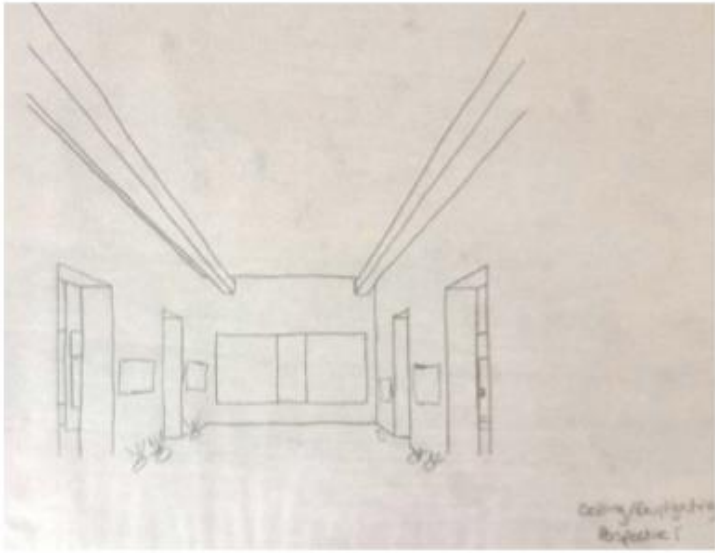

## Problem Resolution Studies -Ceiling/Daylighting 2

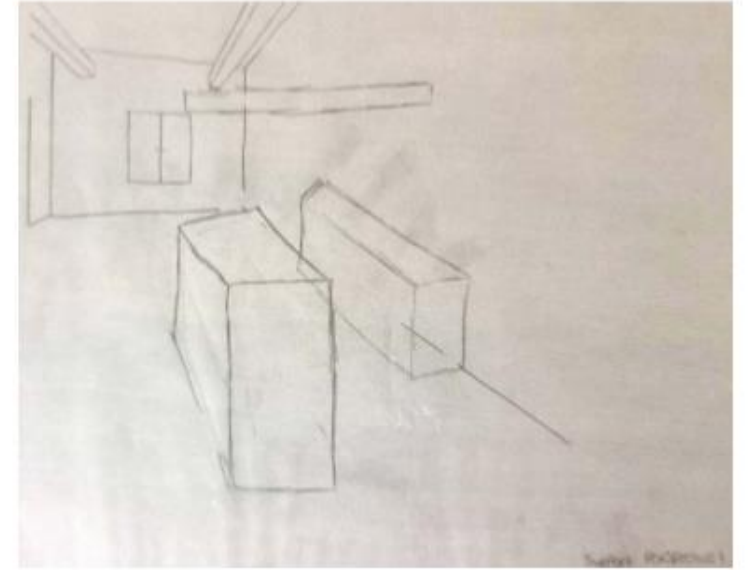
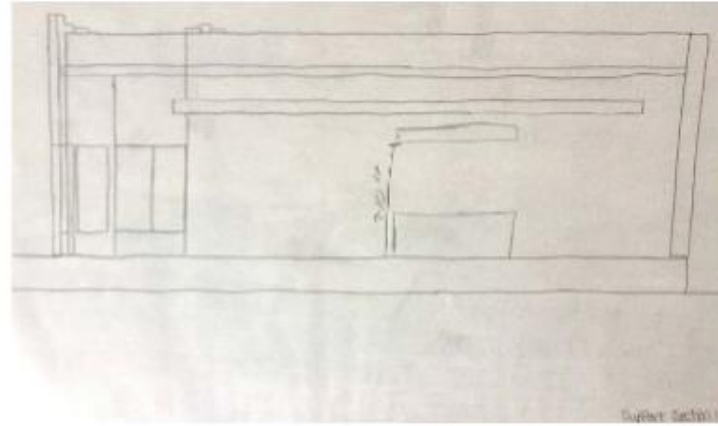
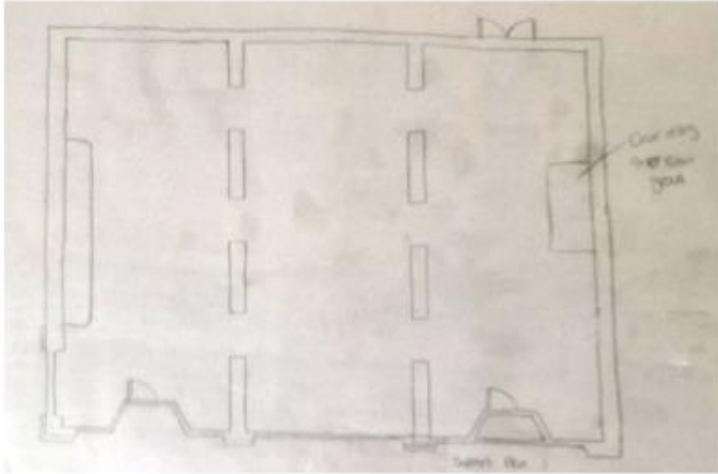

# Problem Resolution Studies-Support Spaces 1

---

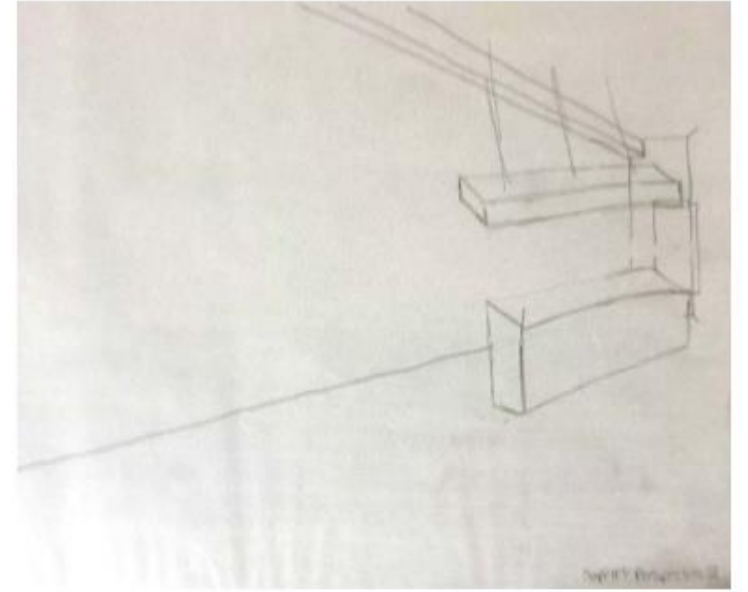
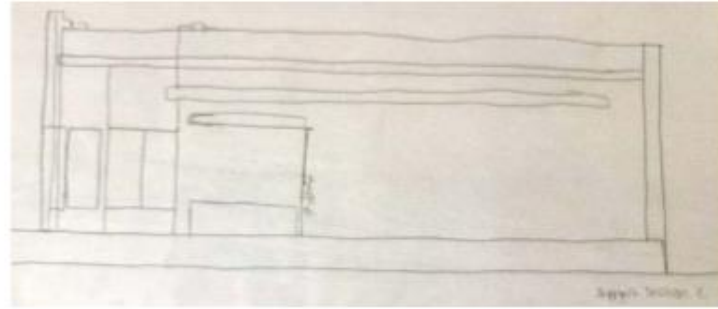
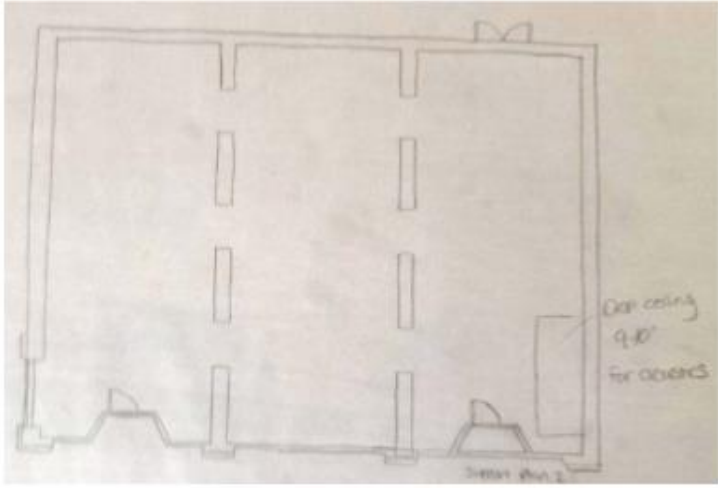

# Problem Resolution Studies -Support Spaces 2

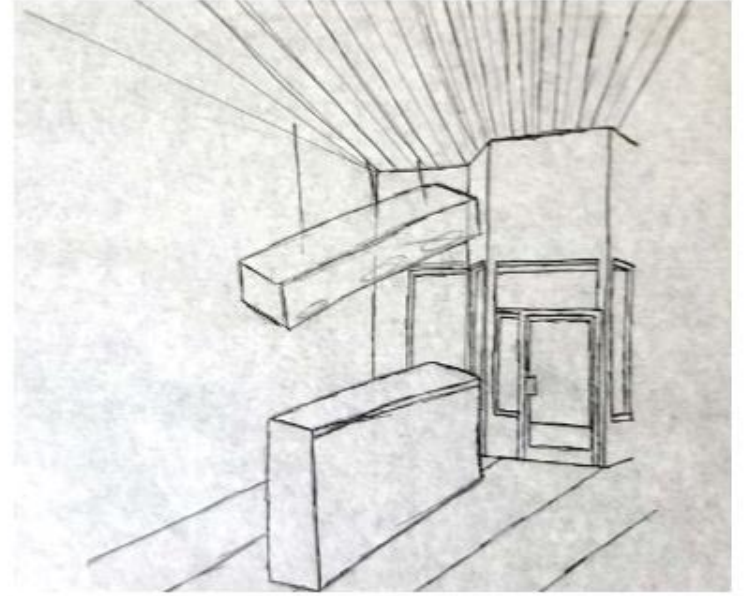
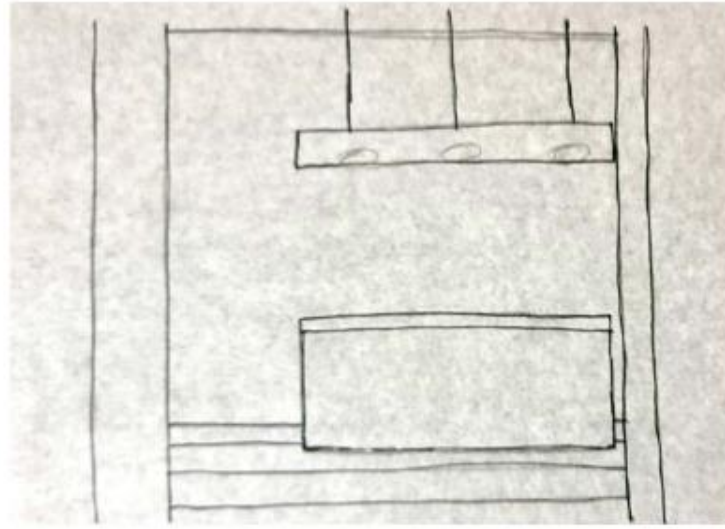
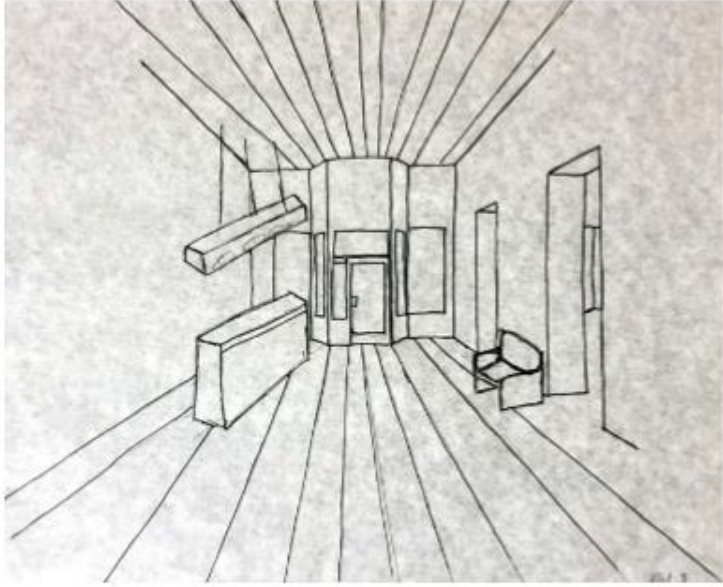

# Design Synthesis Studies - Entry/Reception

---

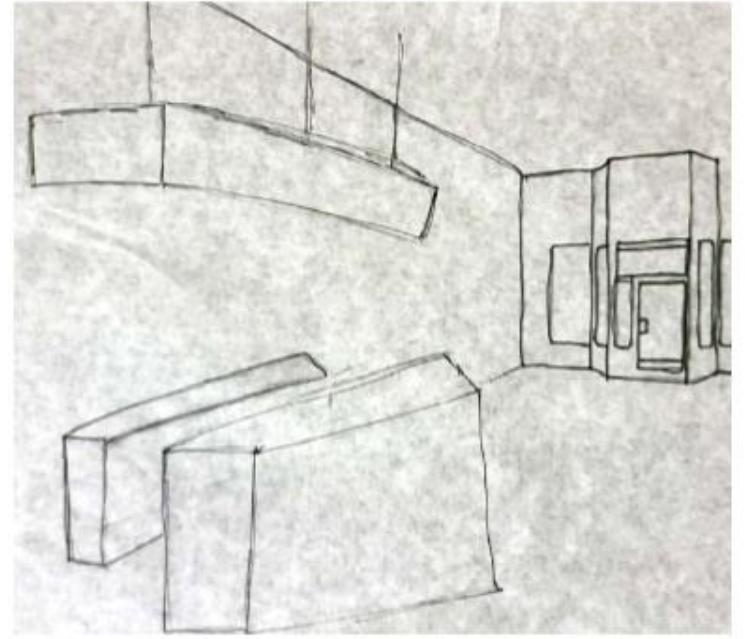
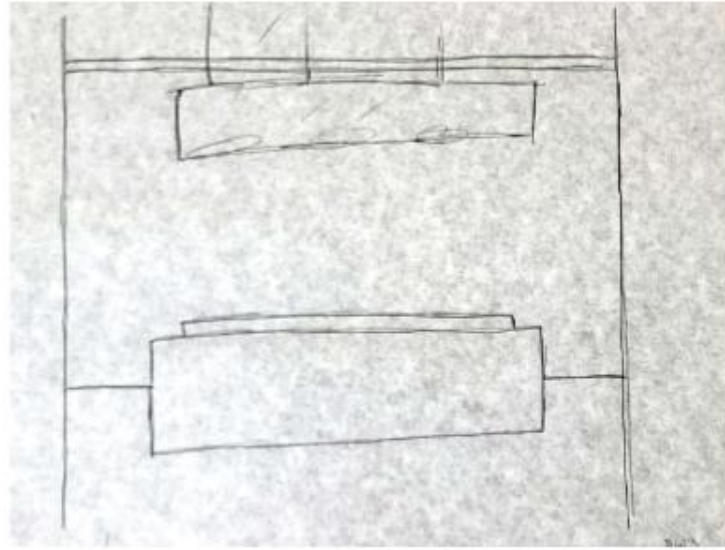
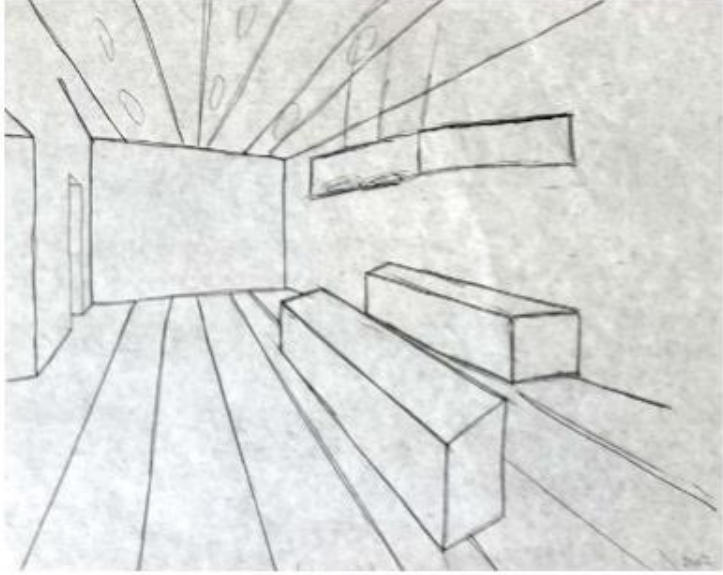

# Design Synthesis Studies -Support Space



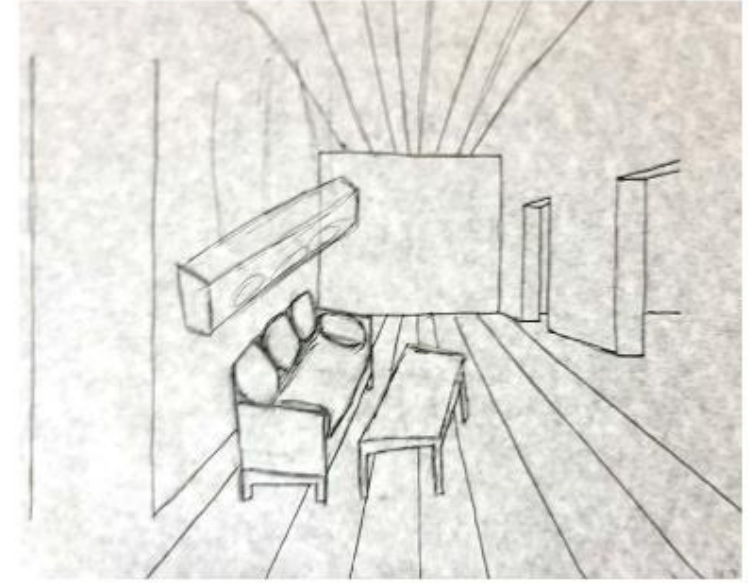
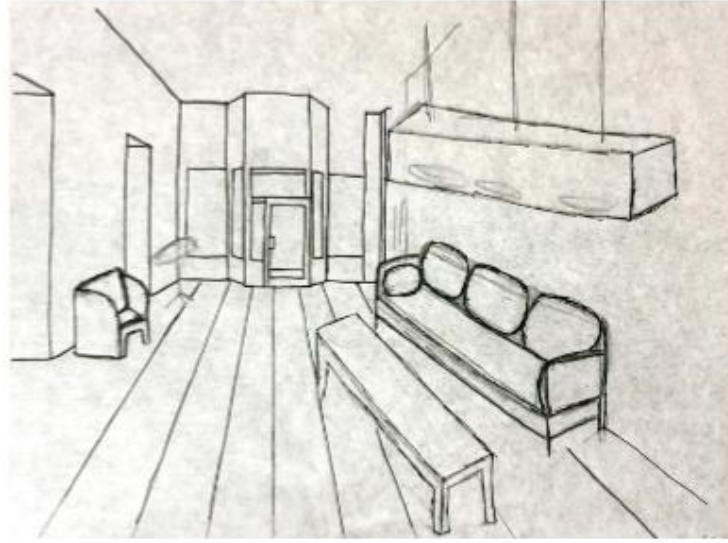
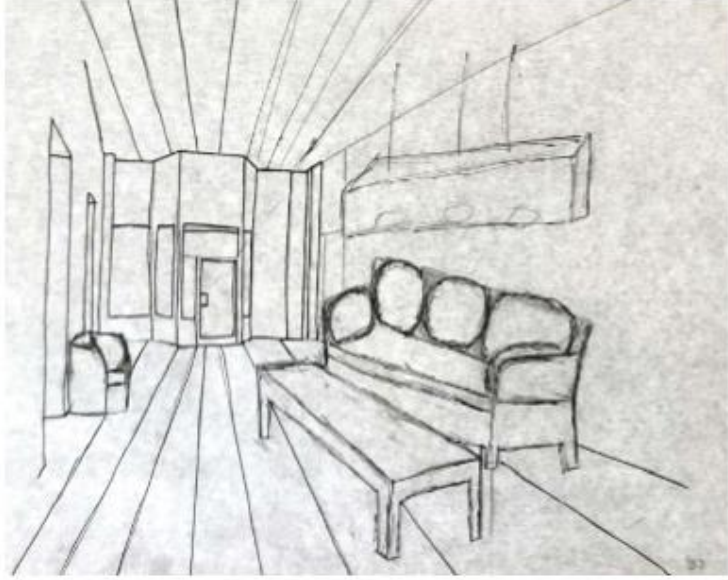

# Design Synthesis Studies -Lounge

---

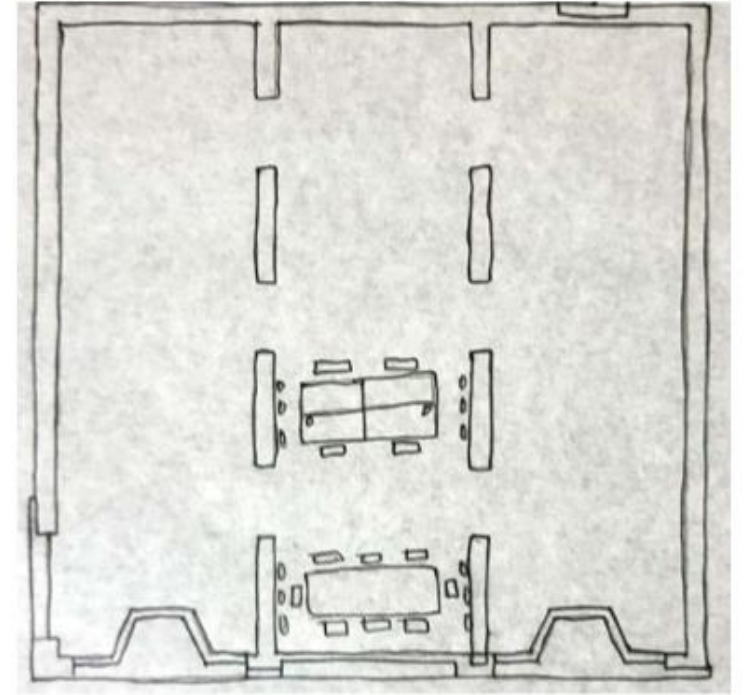
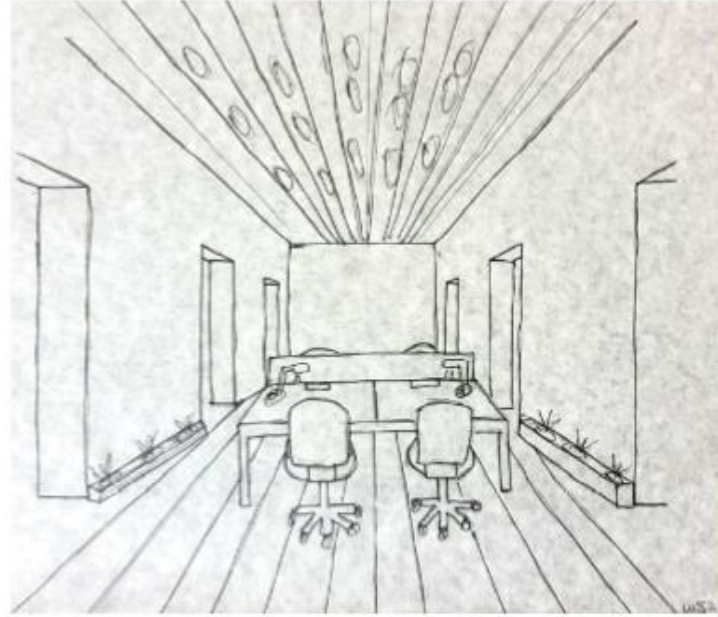
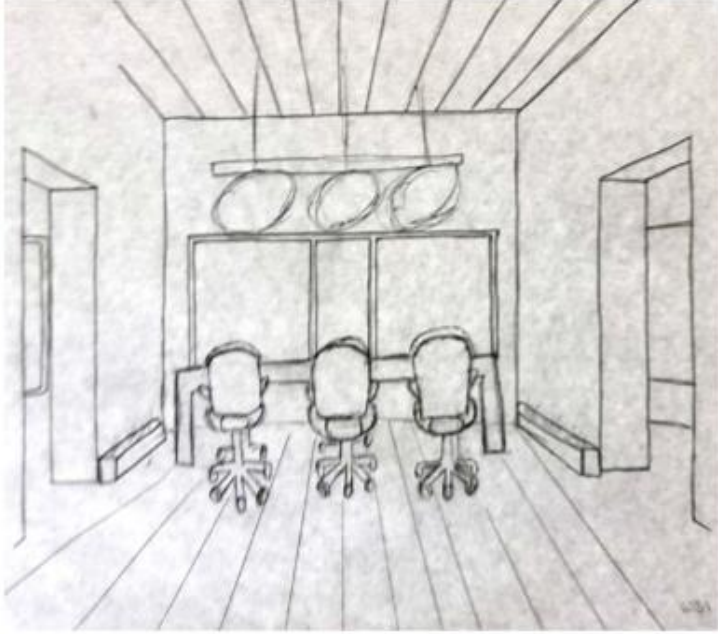

Design Synthesis Studies - Workstations

# Furniture and Finish Palettes

---

# Entry



# Lounge



# Workstation

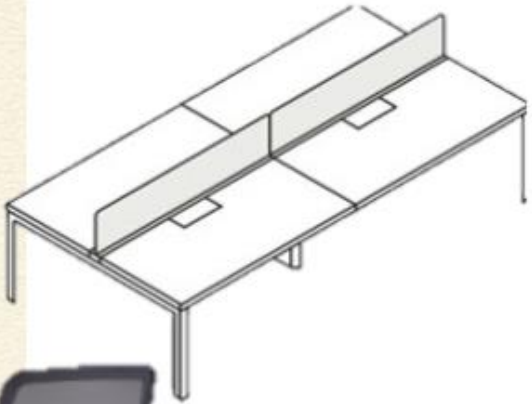



Lighting Model

---