

Portfolio II: Preliminary Design

Jaden McGathen

IDSN 3102-Fall 2021

Gustina

Assignment 6:  
Circulation Plan  
A

COTANÔCHE STREET

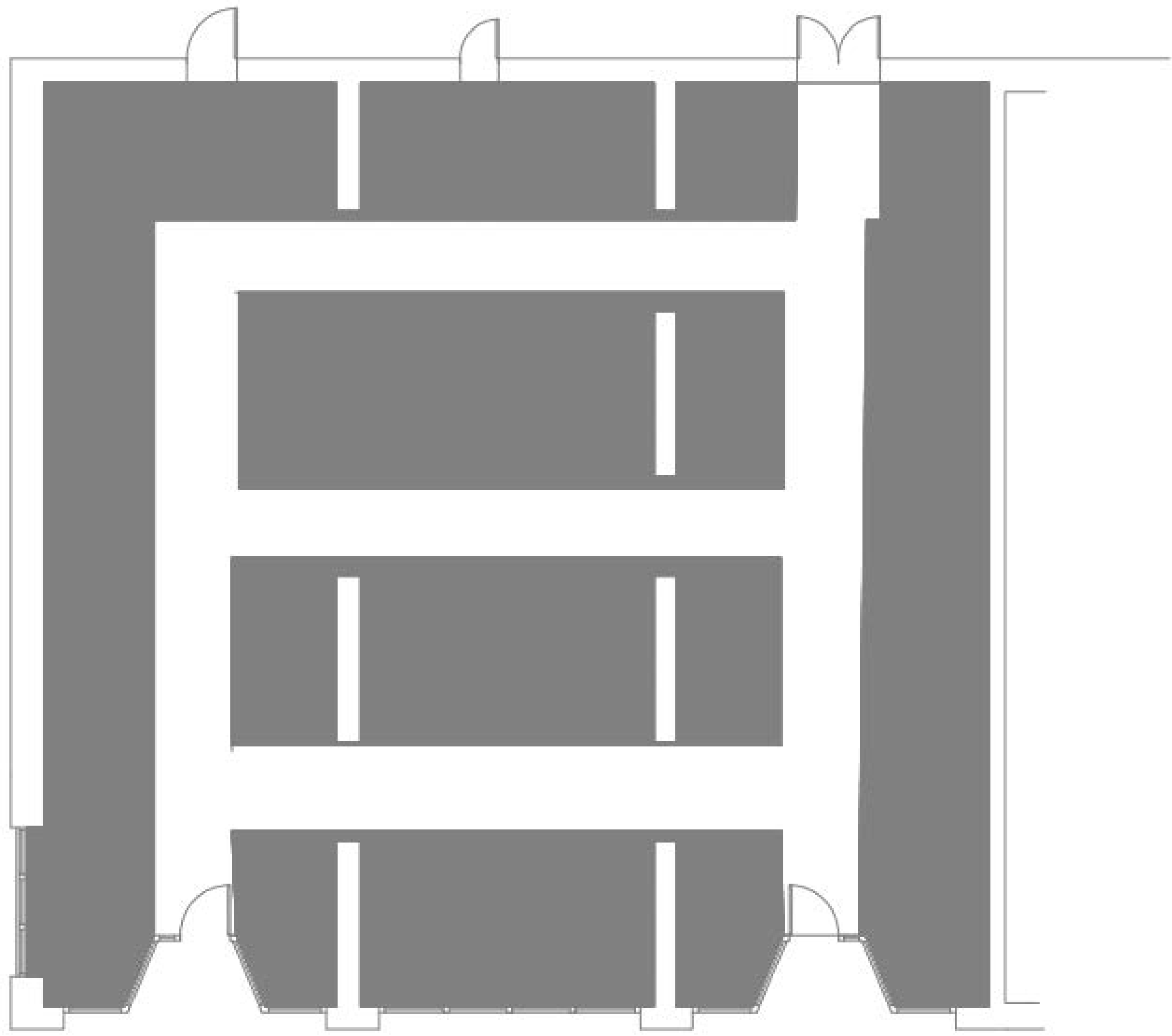

201 E. 5TH

203 E. 5TH

205 E. 5TH

EAST 5TH STREET

Assignment 6:  
Circulation Plan  
B

COTANCHE STREET

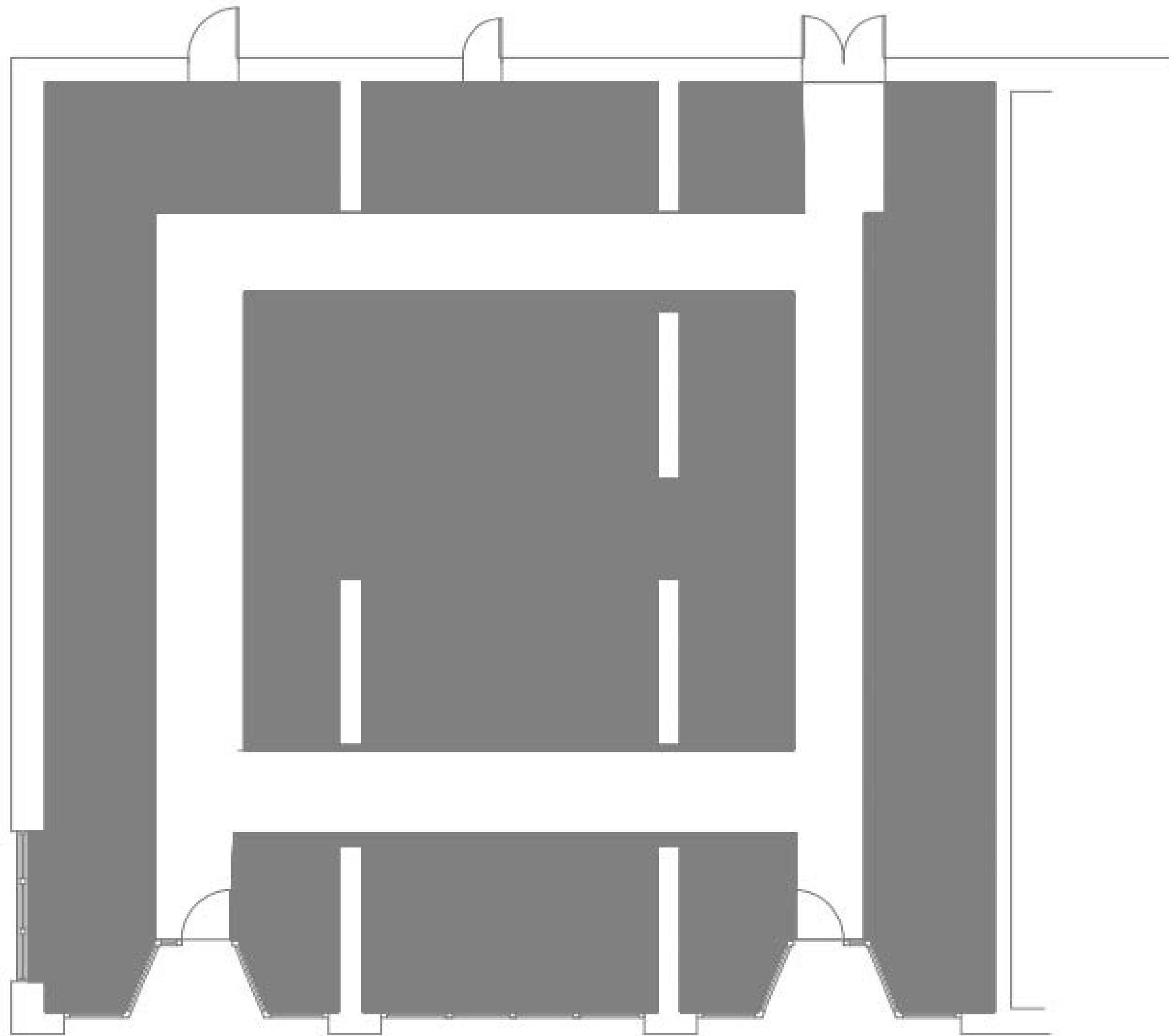

201 E. 5TH

203 E. 5TH

205 E. 5TH

EAST 5TH STREET

# Assignment 7: Ductwork Locations

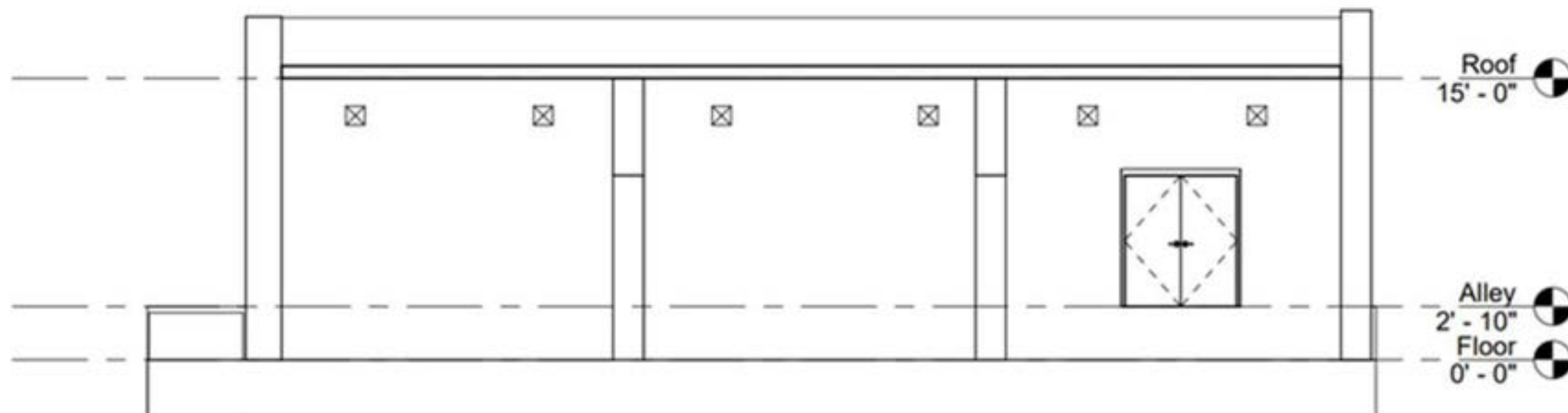
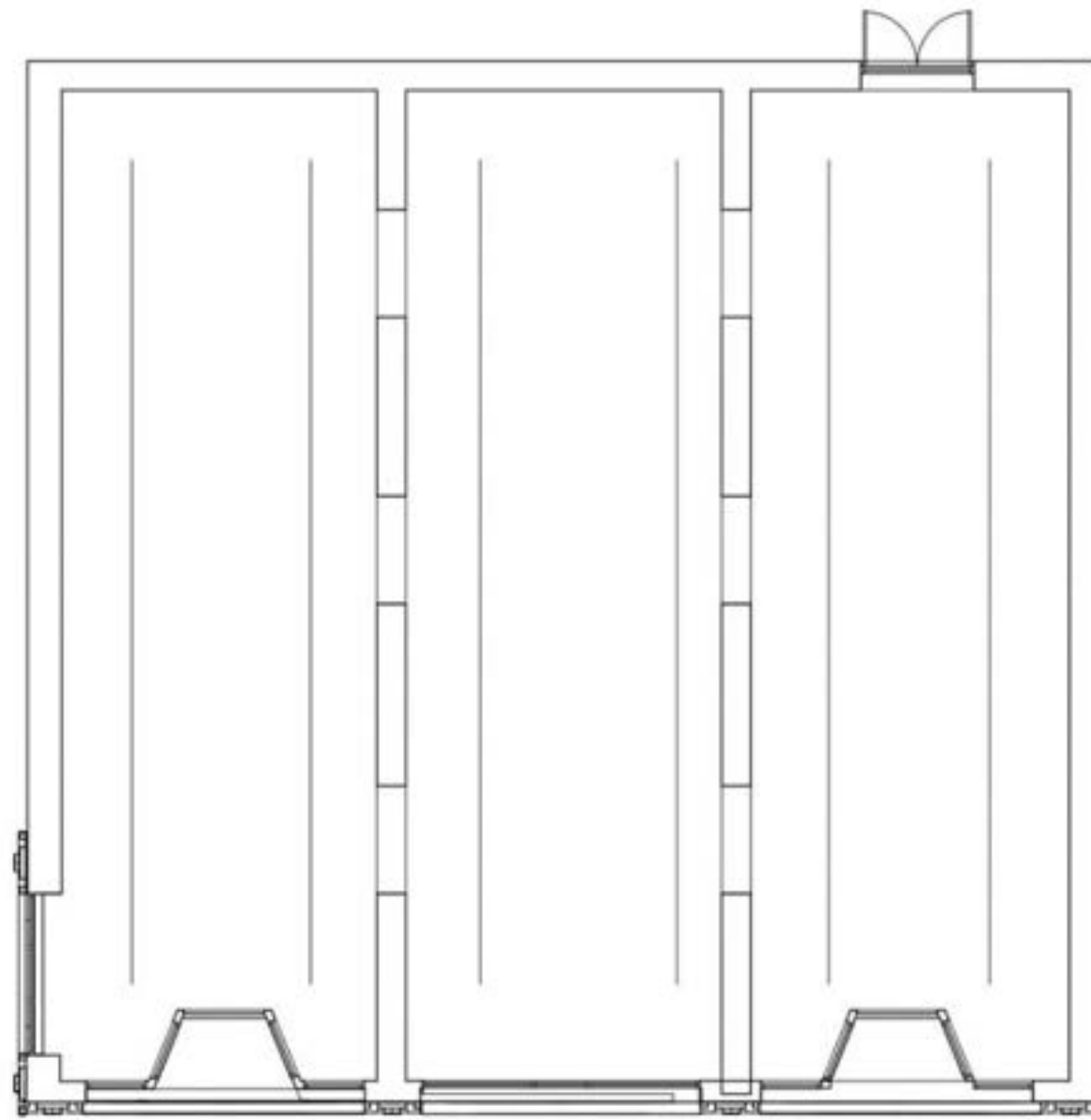

# Assignment 8: Space Plan Sketches

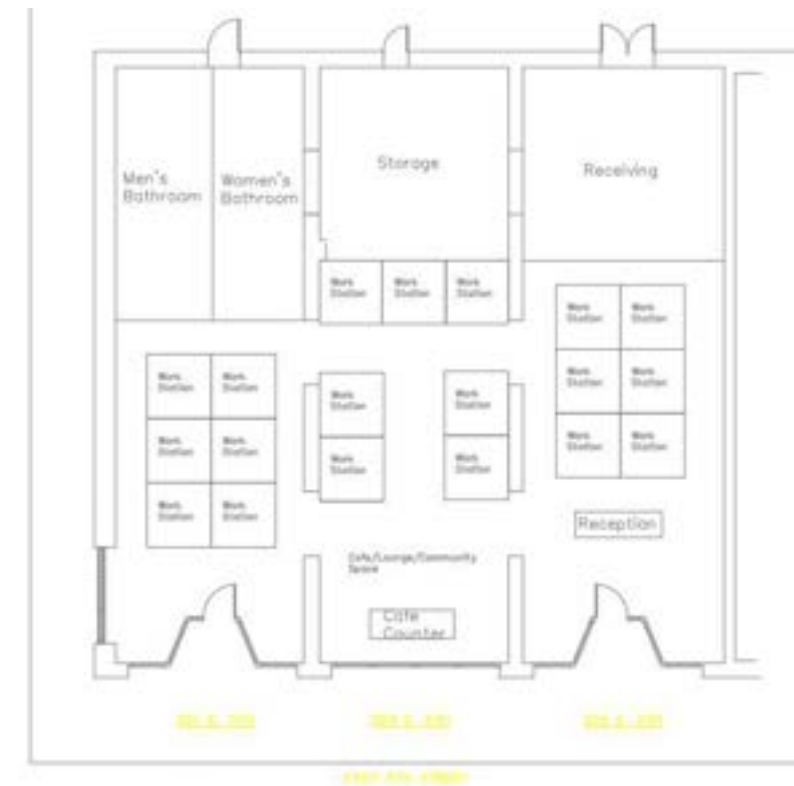
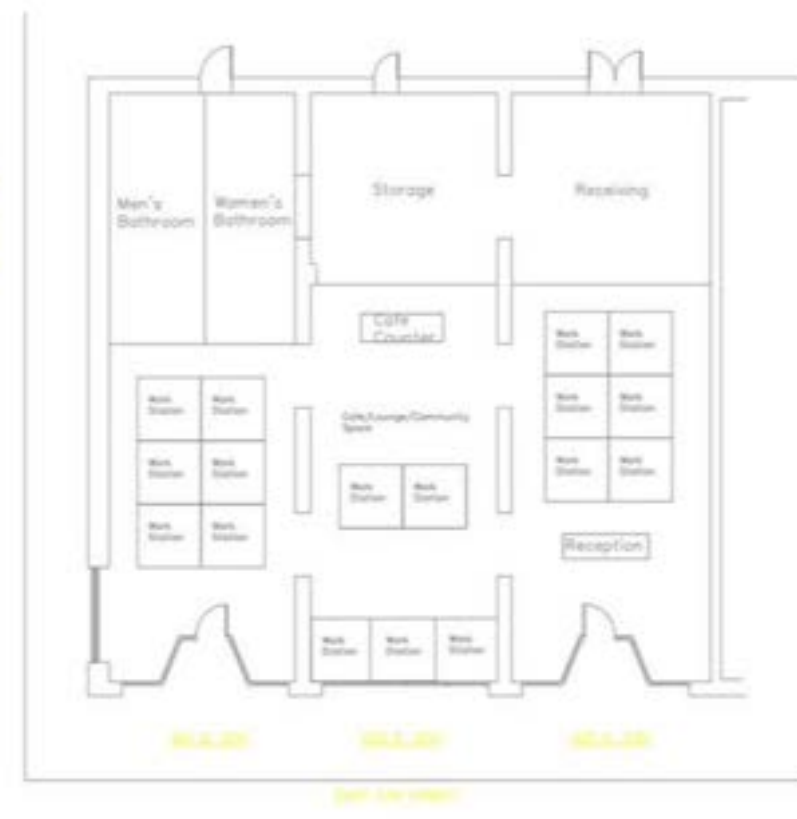
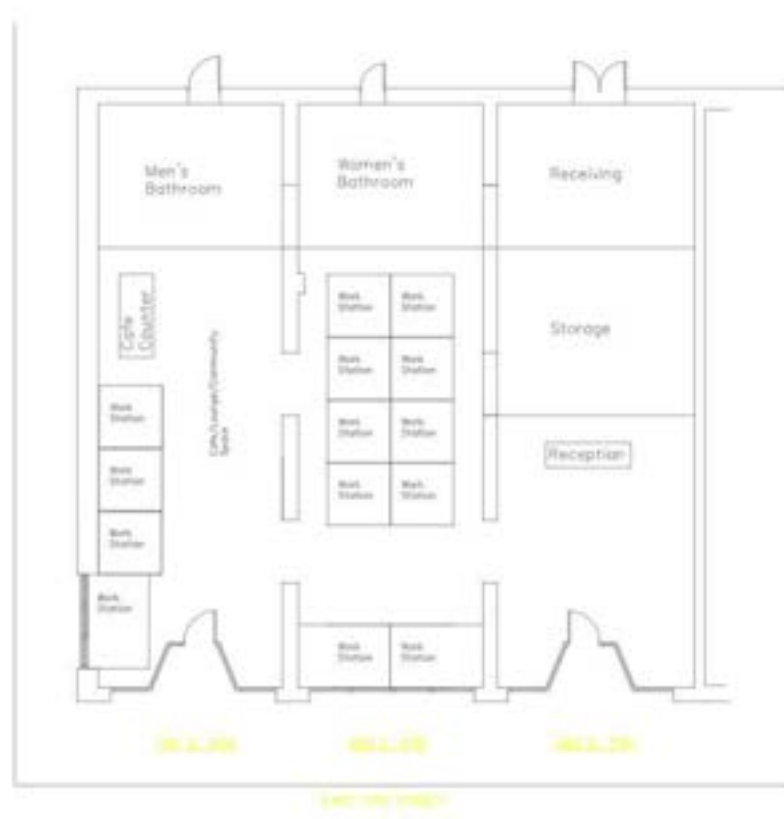
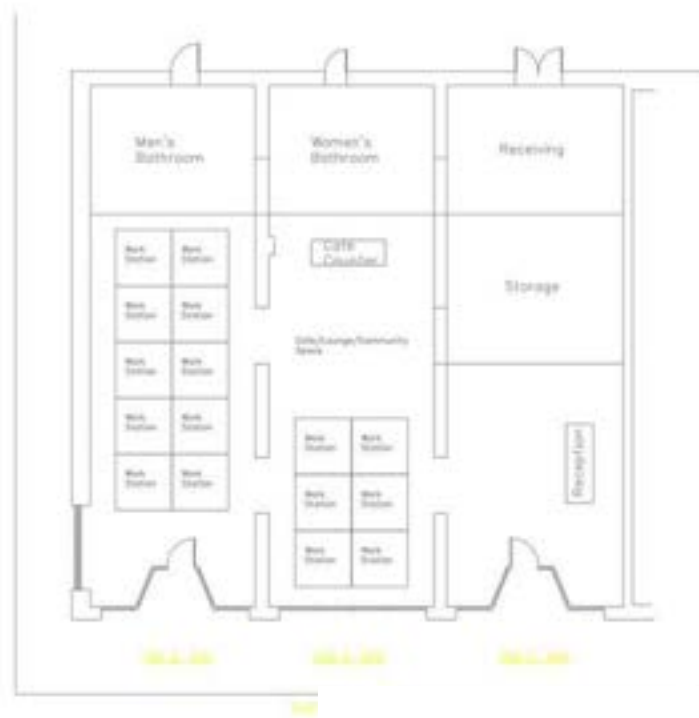

Assignment 9:  
Problem  
Resolution  
Studies –  
Exploration

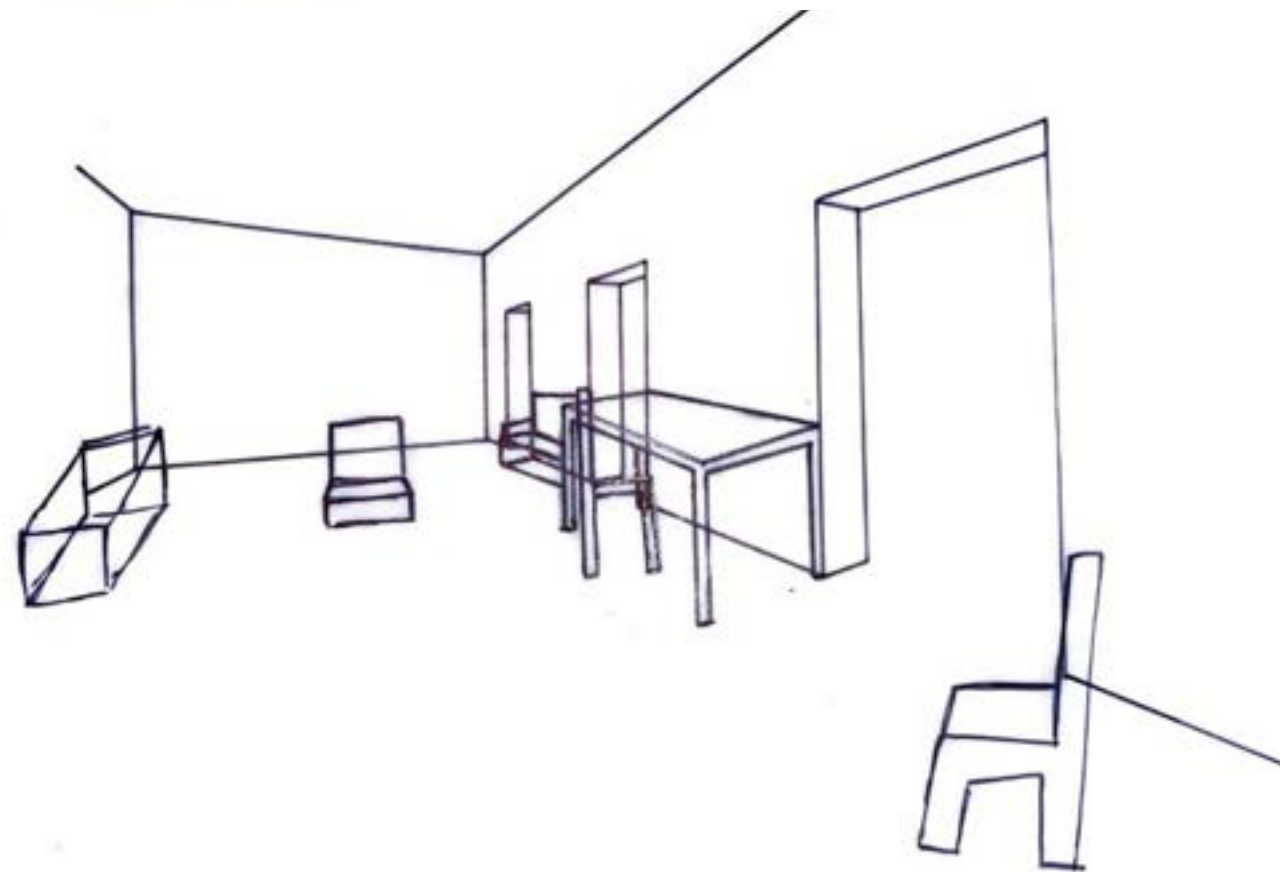
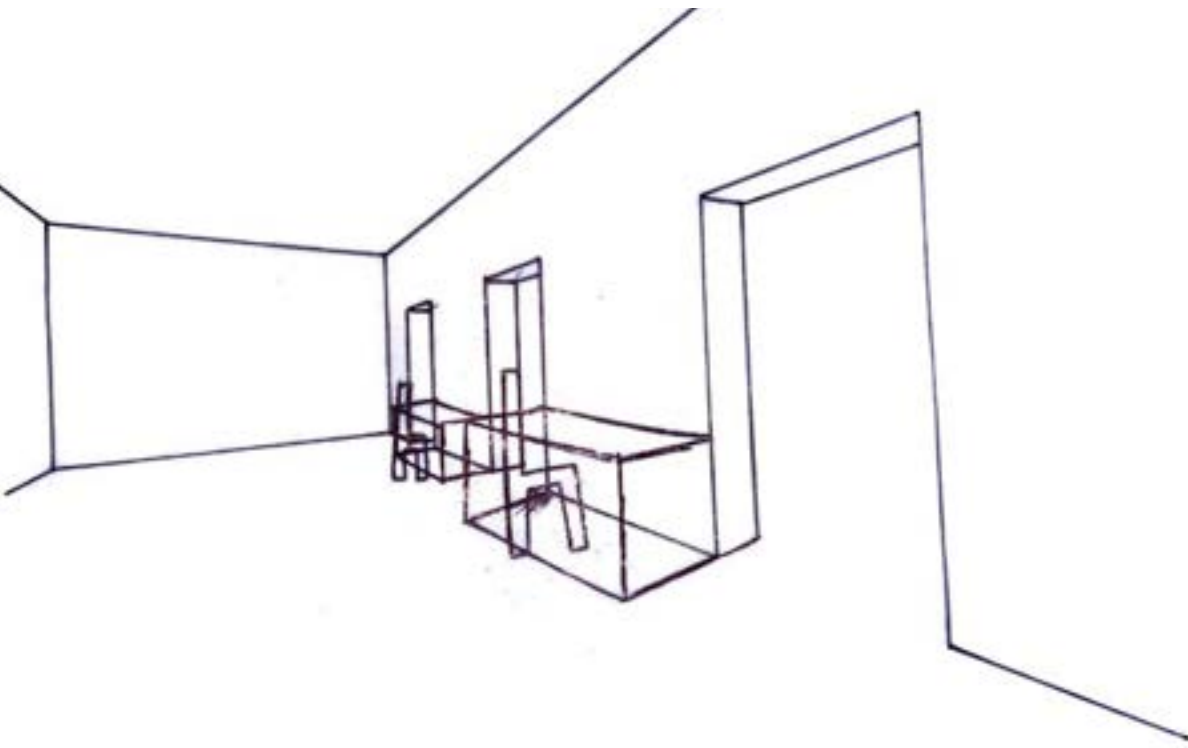
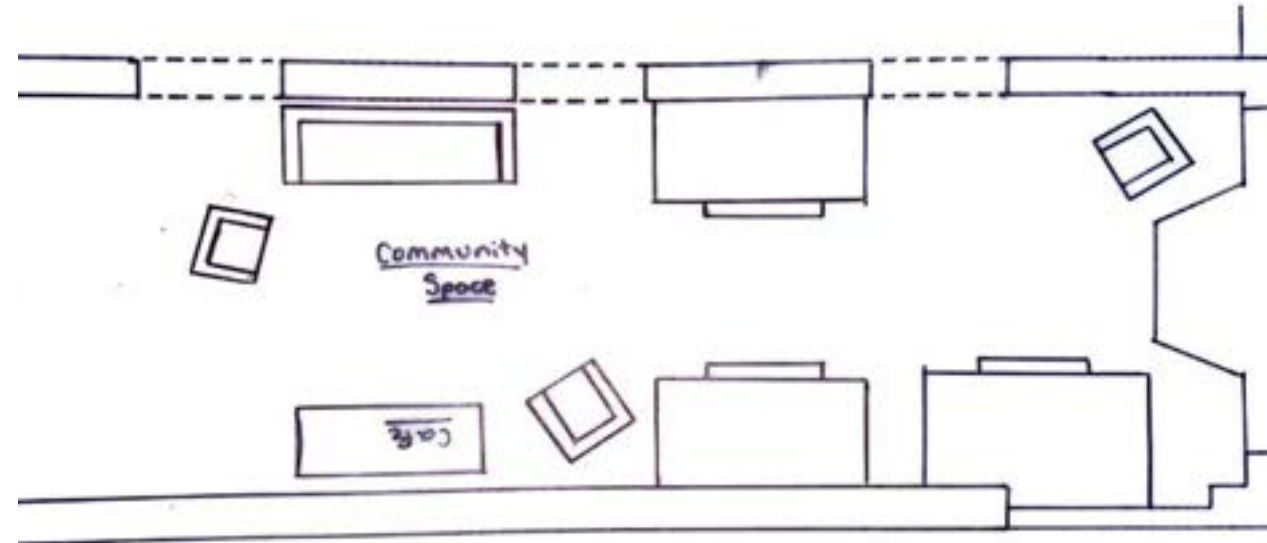
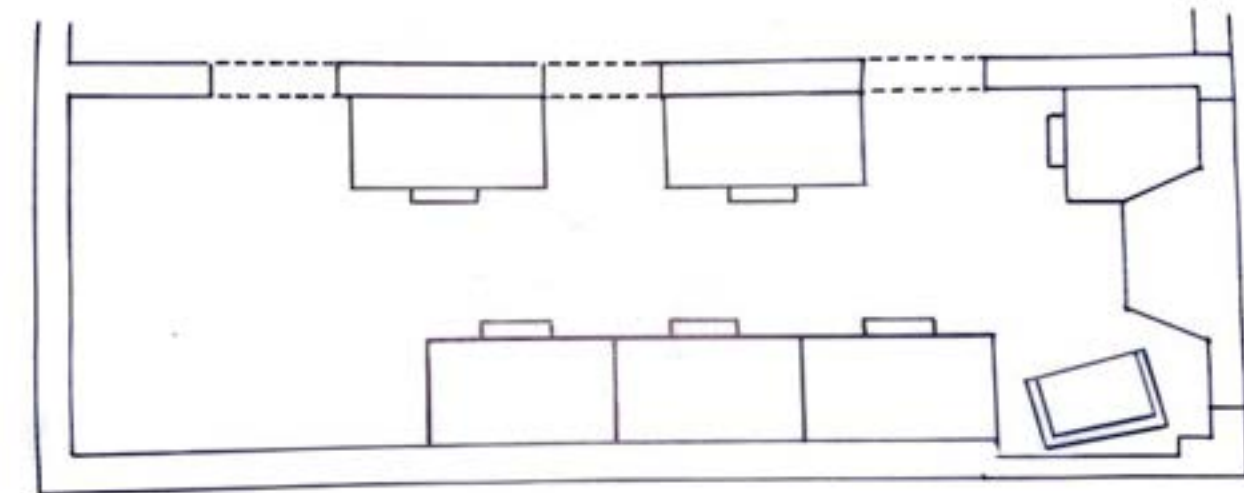
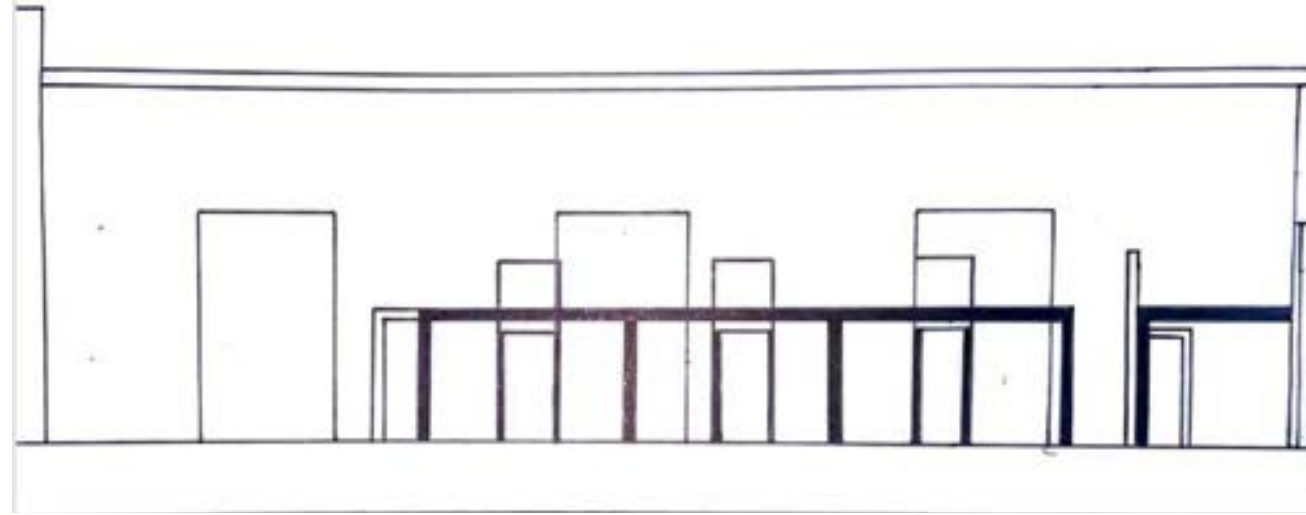
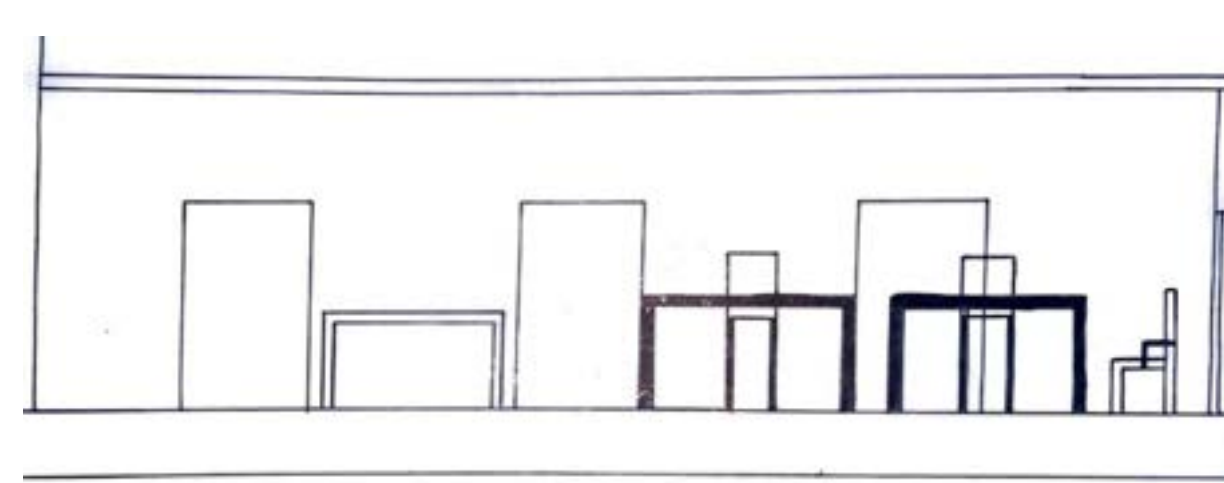

Assignment 9:  
Problem  
Resolution  
Studies – Entry

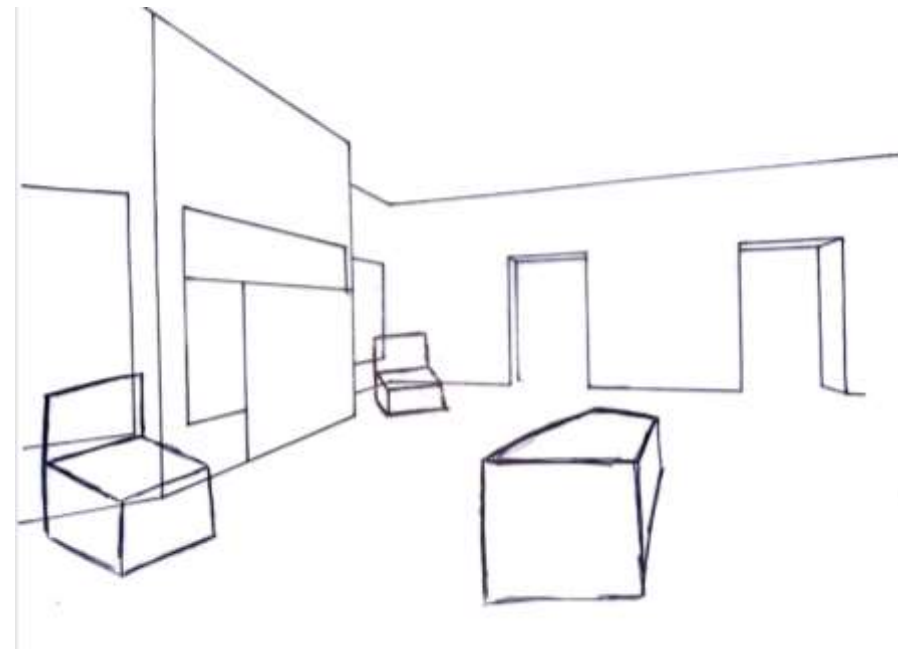
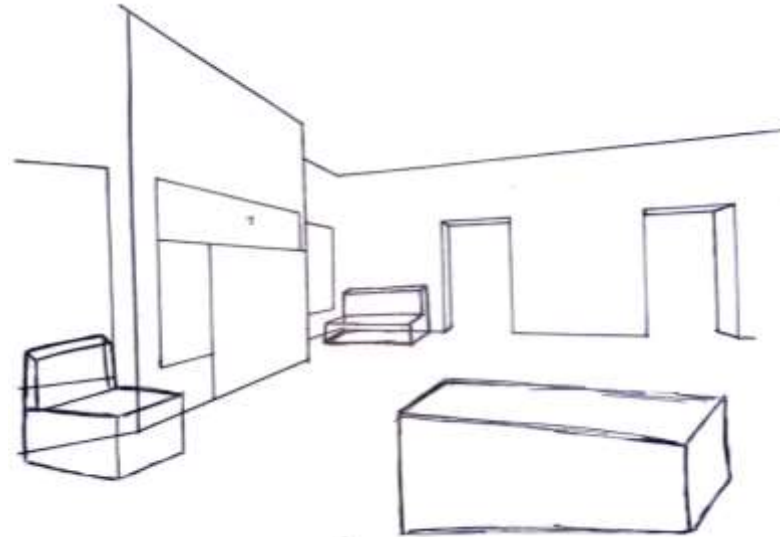
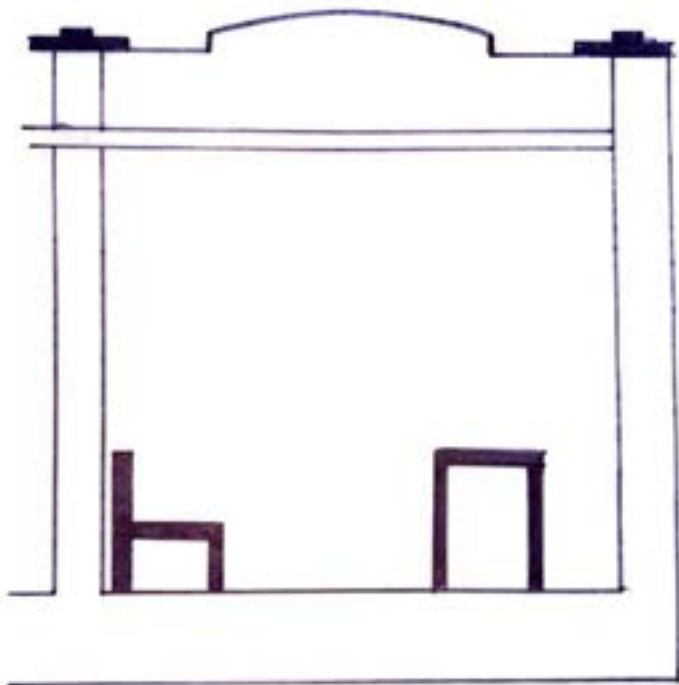
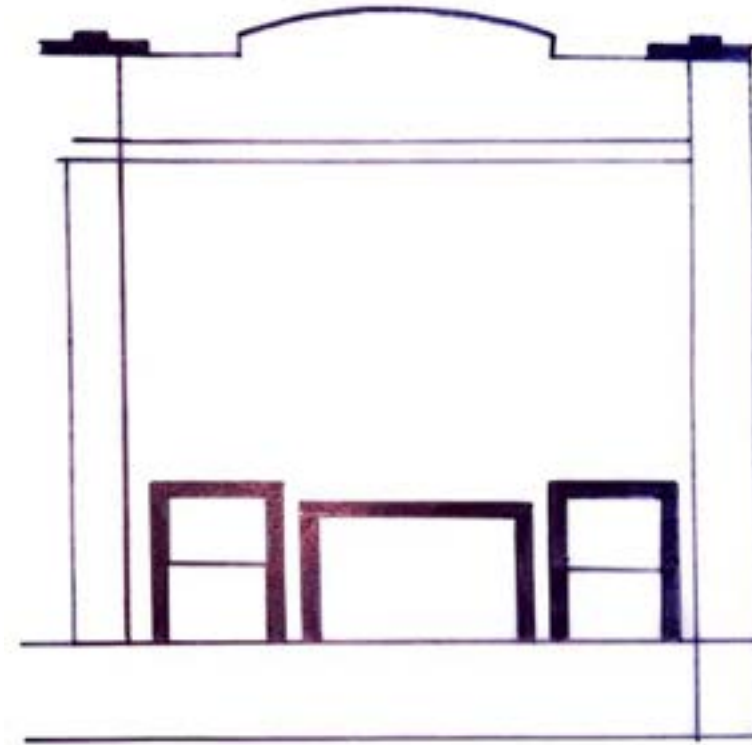
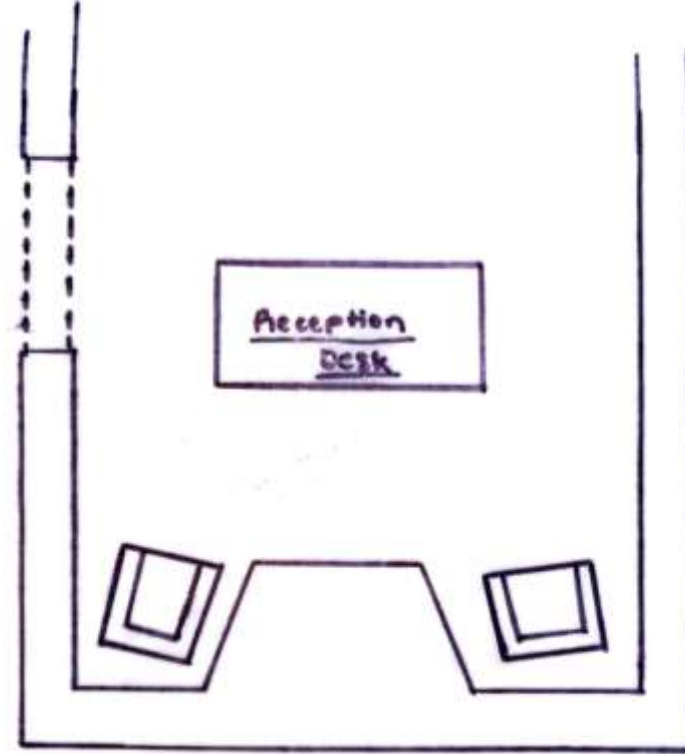
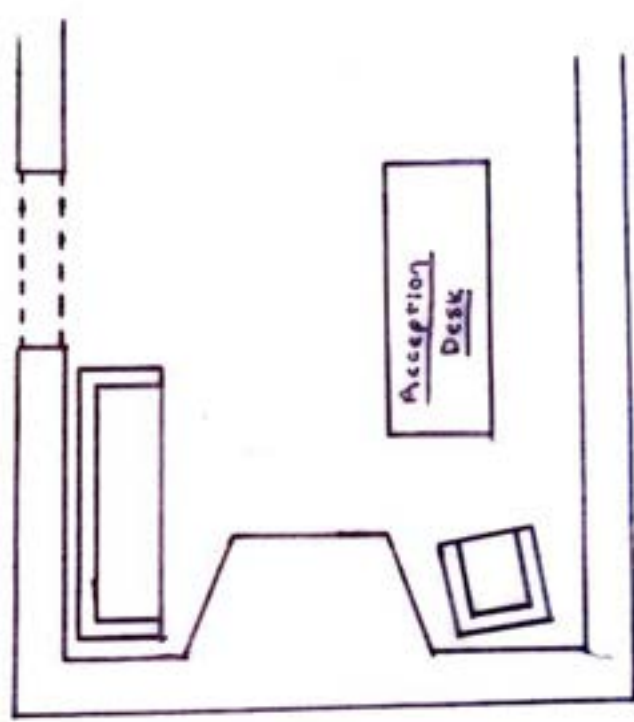

Assignment 9:  
Problem  
Resolution  
Studies –  
Ceiling/Daylight

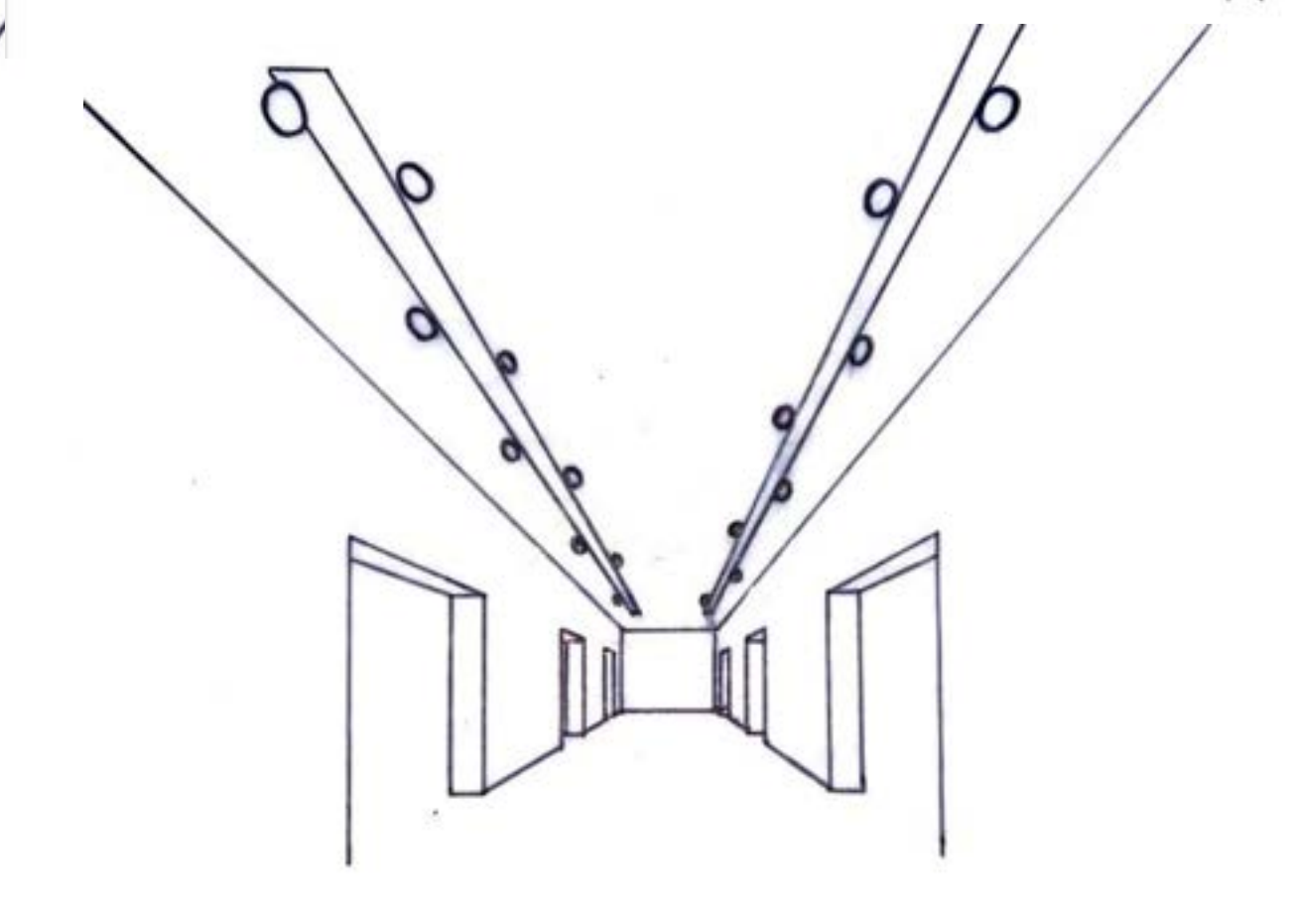
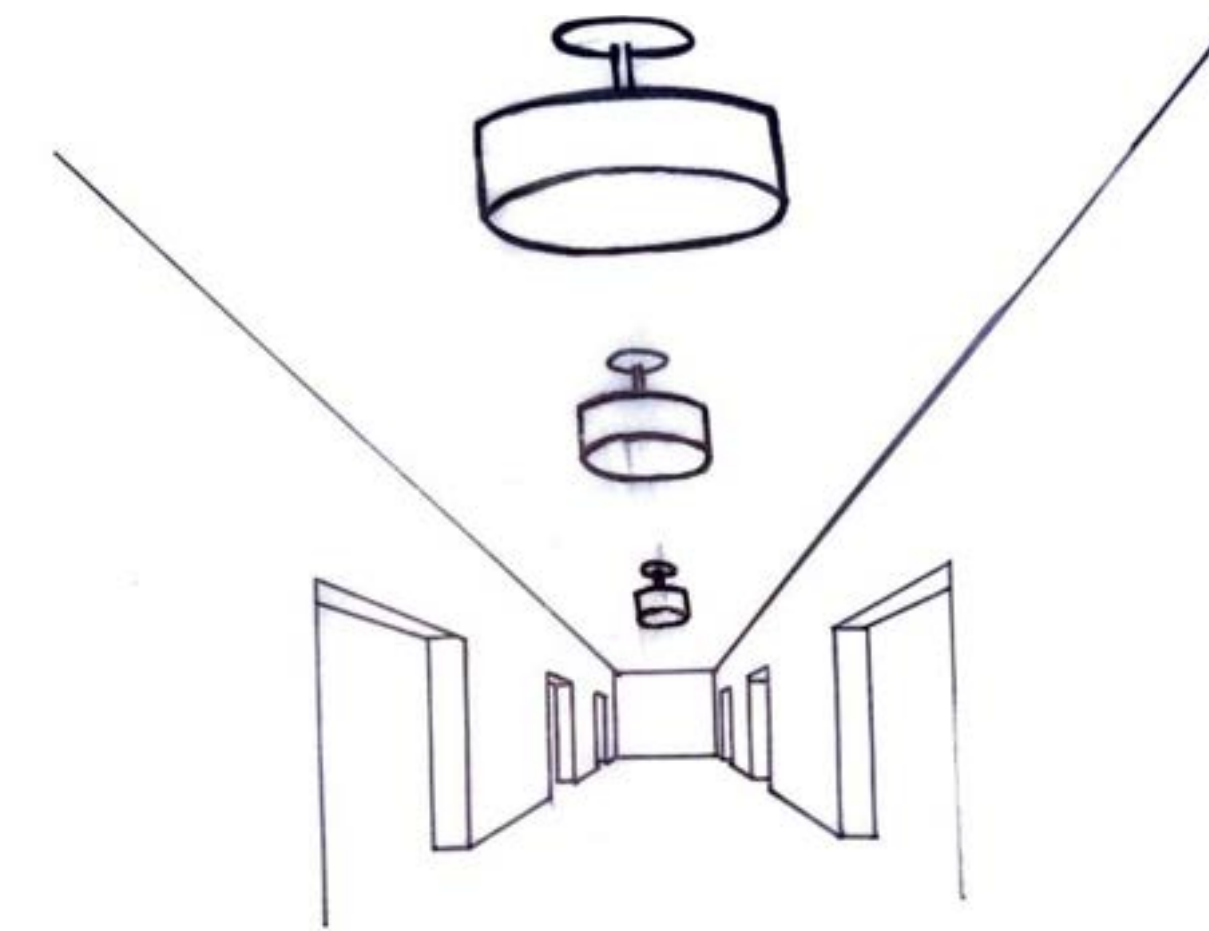
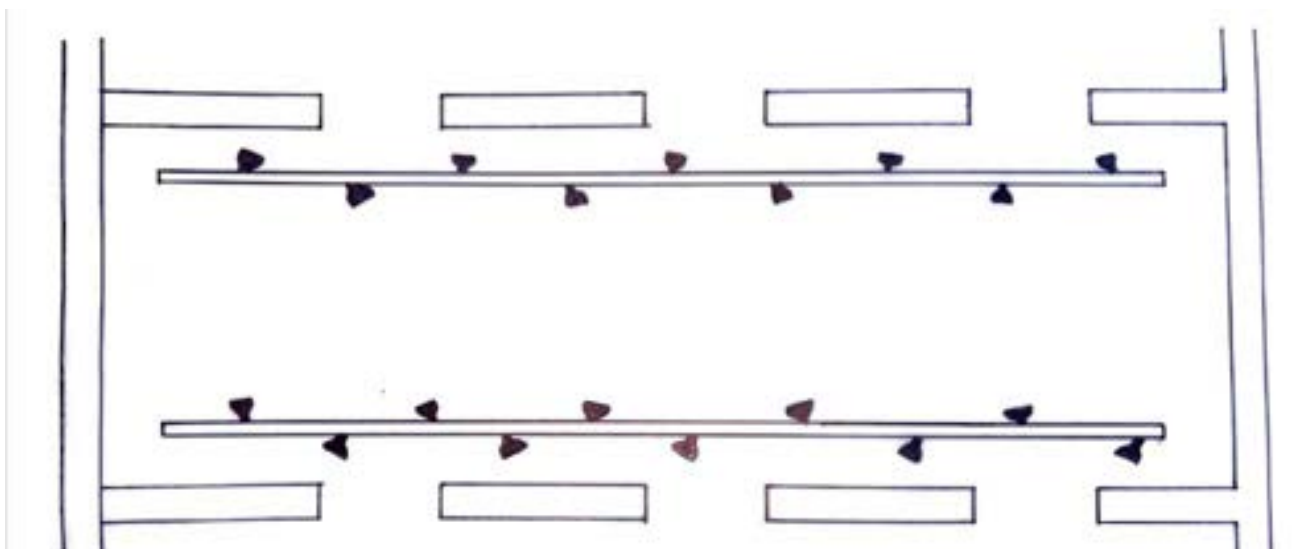
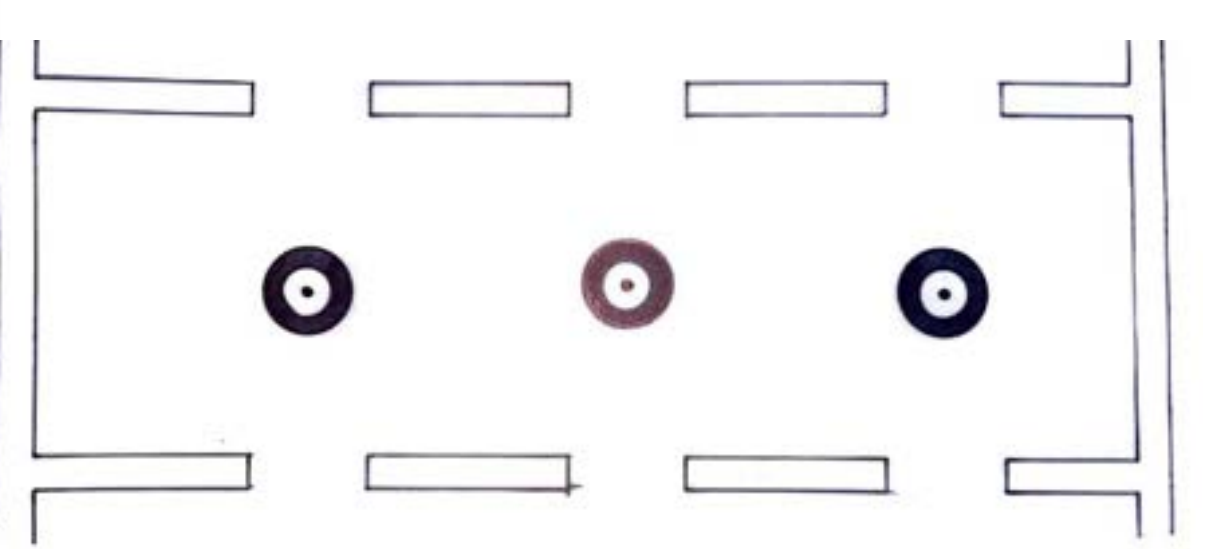
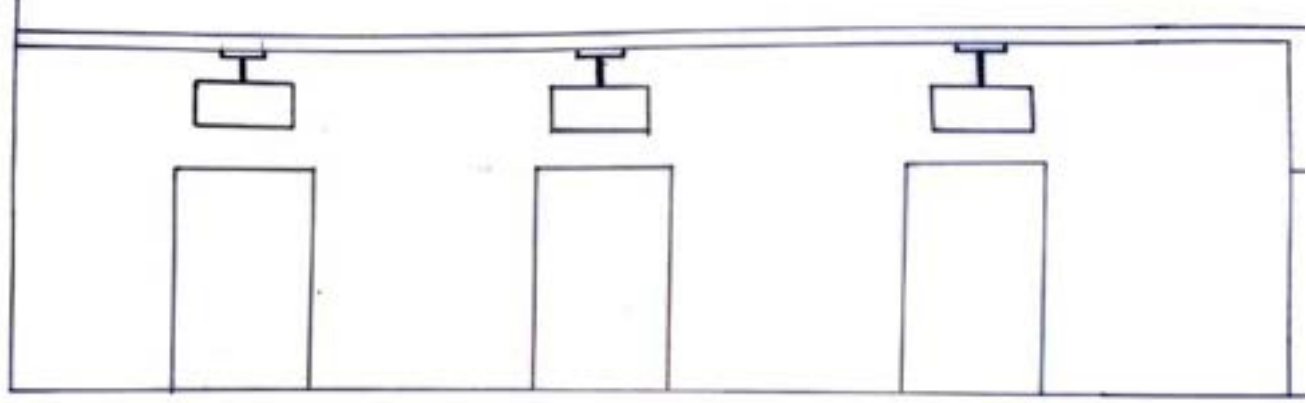
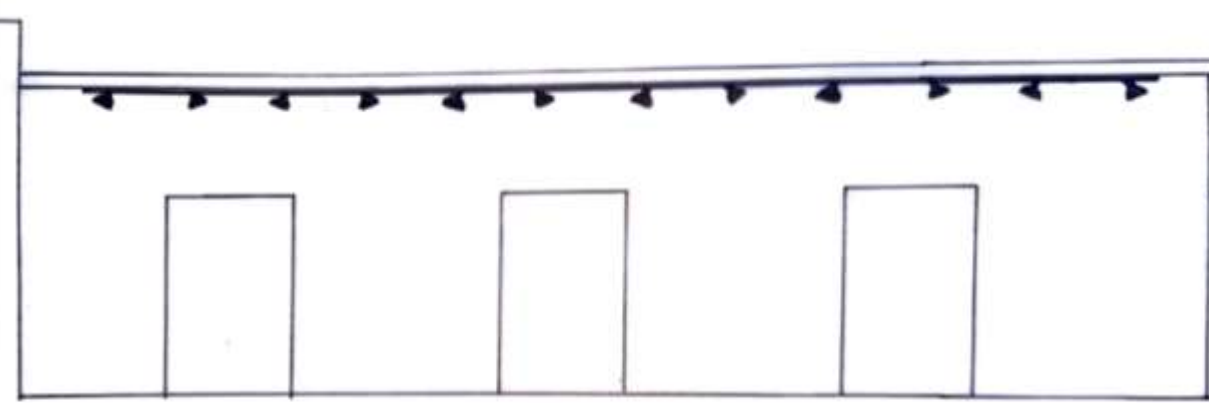



Assignment 9:  
Problem  
Resolution  
Studies –  
Support Spaces

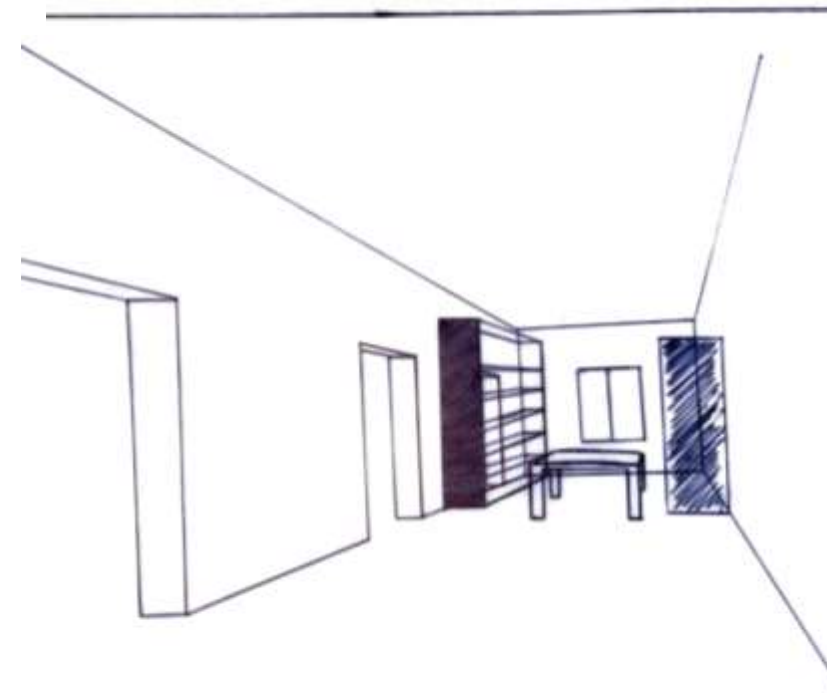
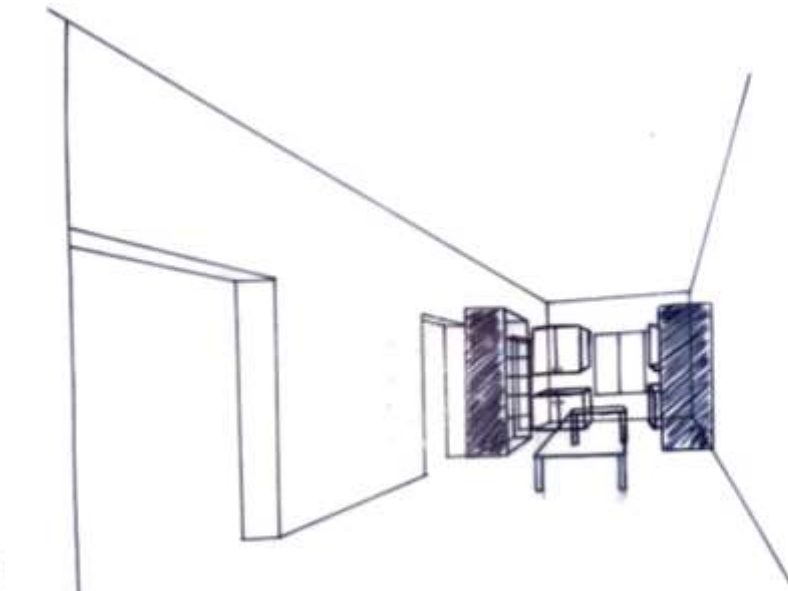
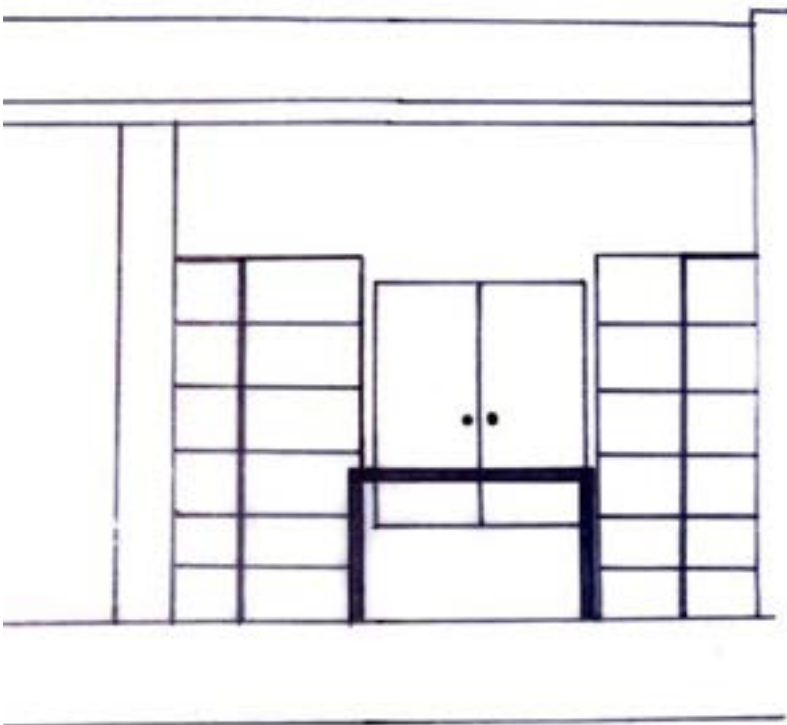
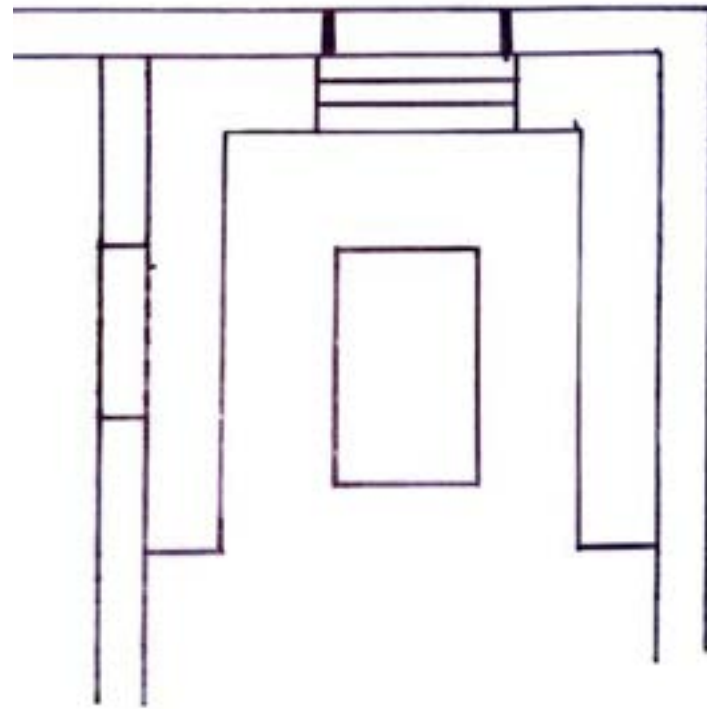
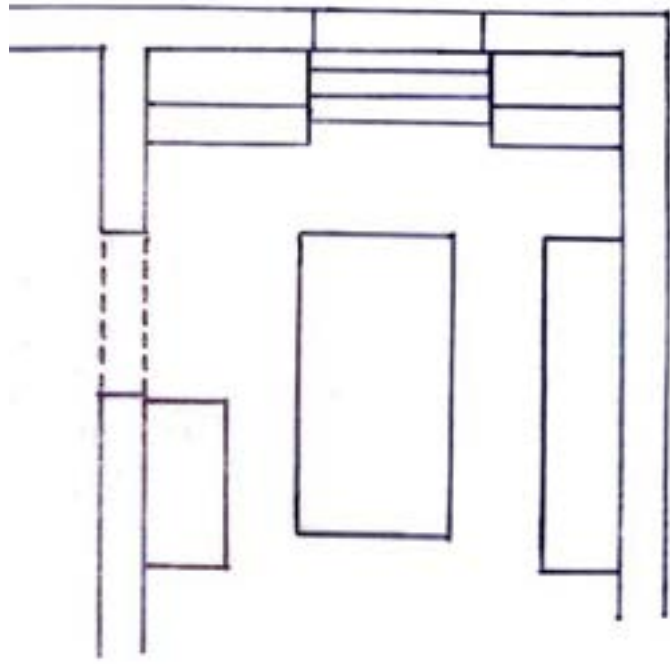

Assignment 10:  
Design Synthesis  
Studies-  
Entry/Reception

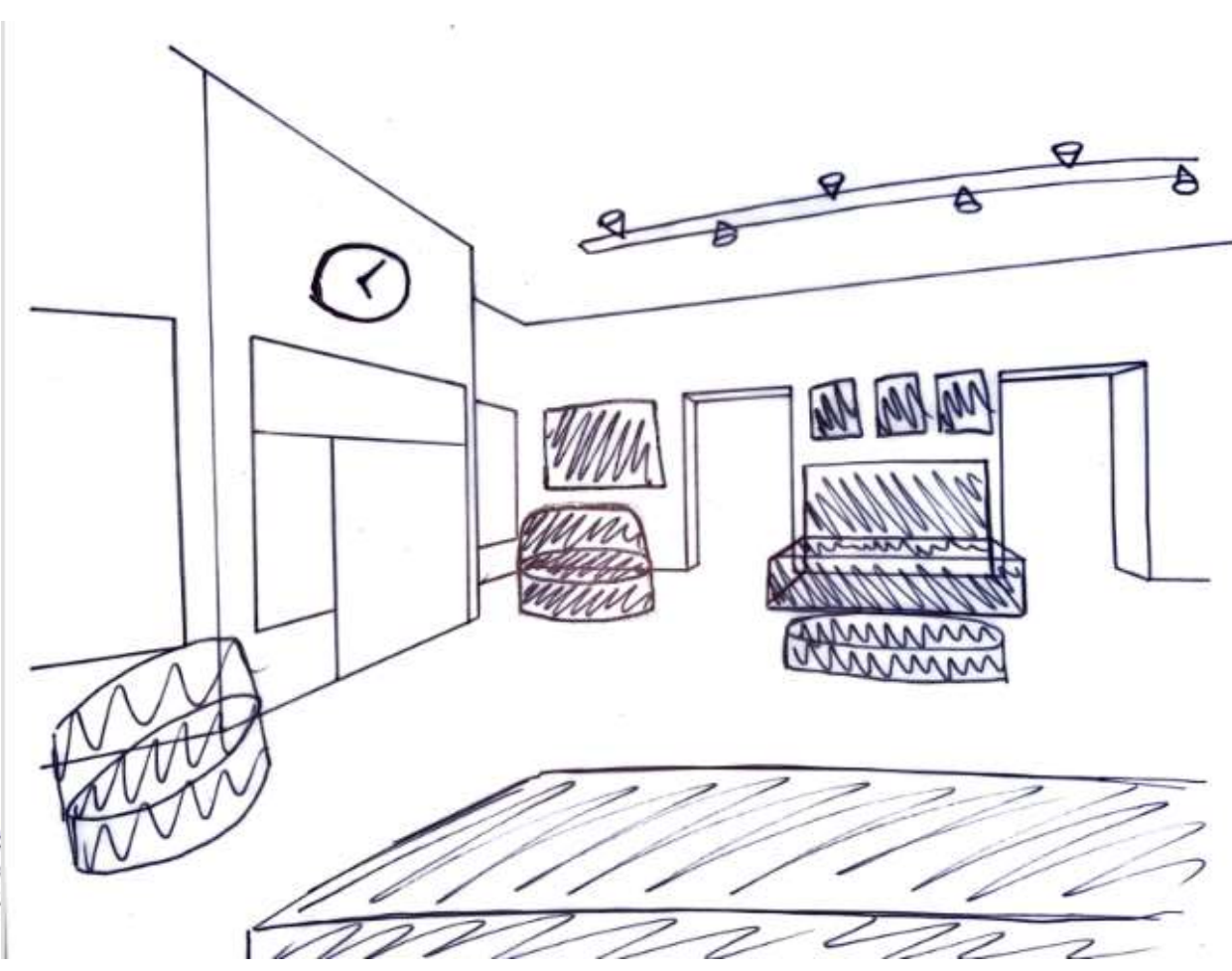
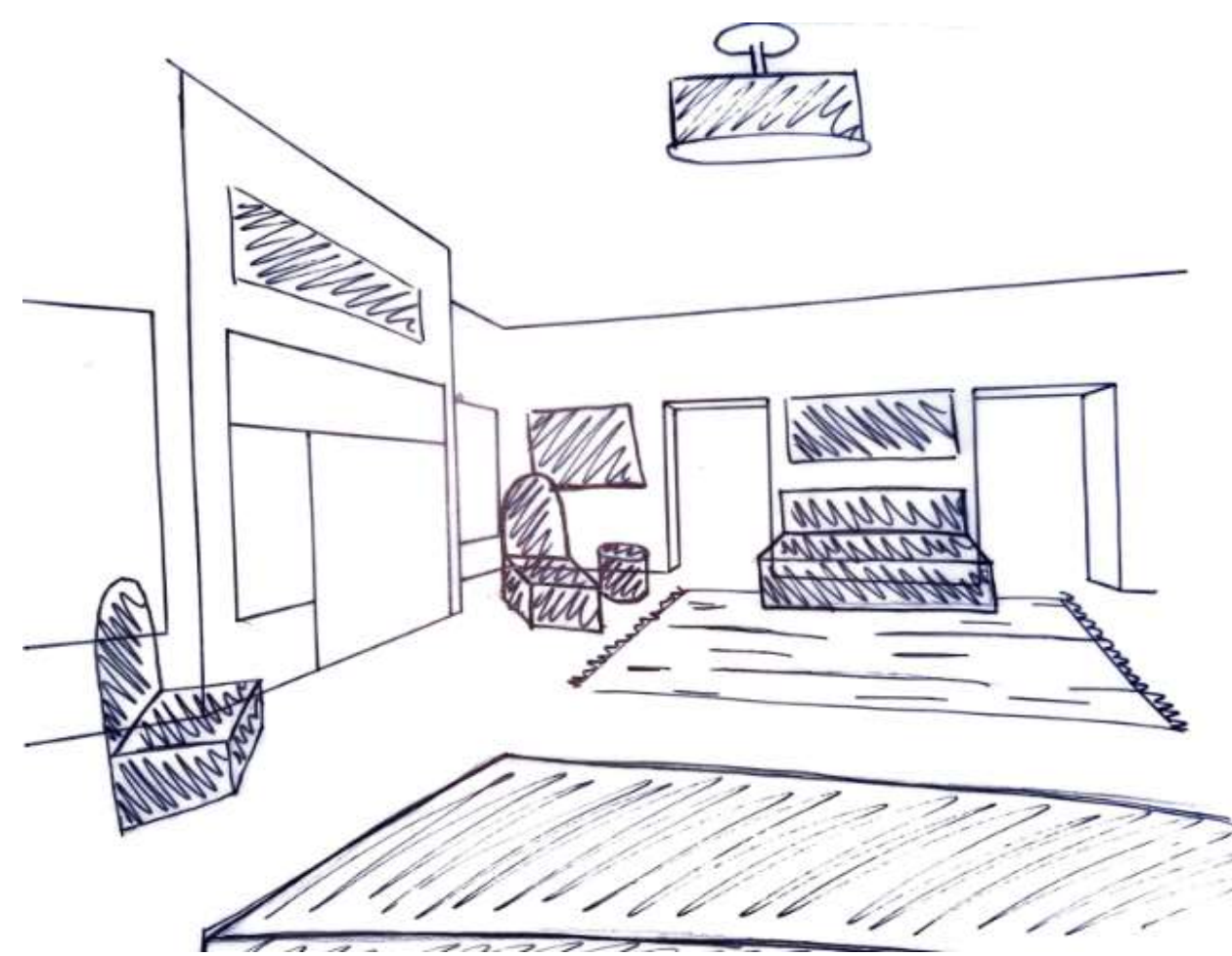

Assignment 10:  
Design Synthesis  
Studies- Lounge

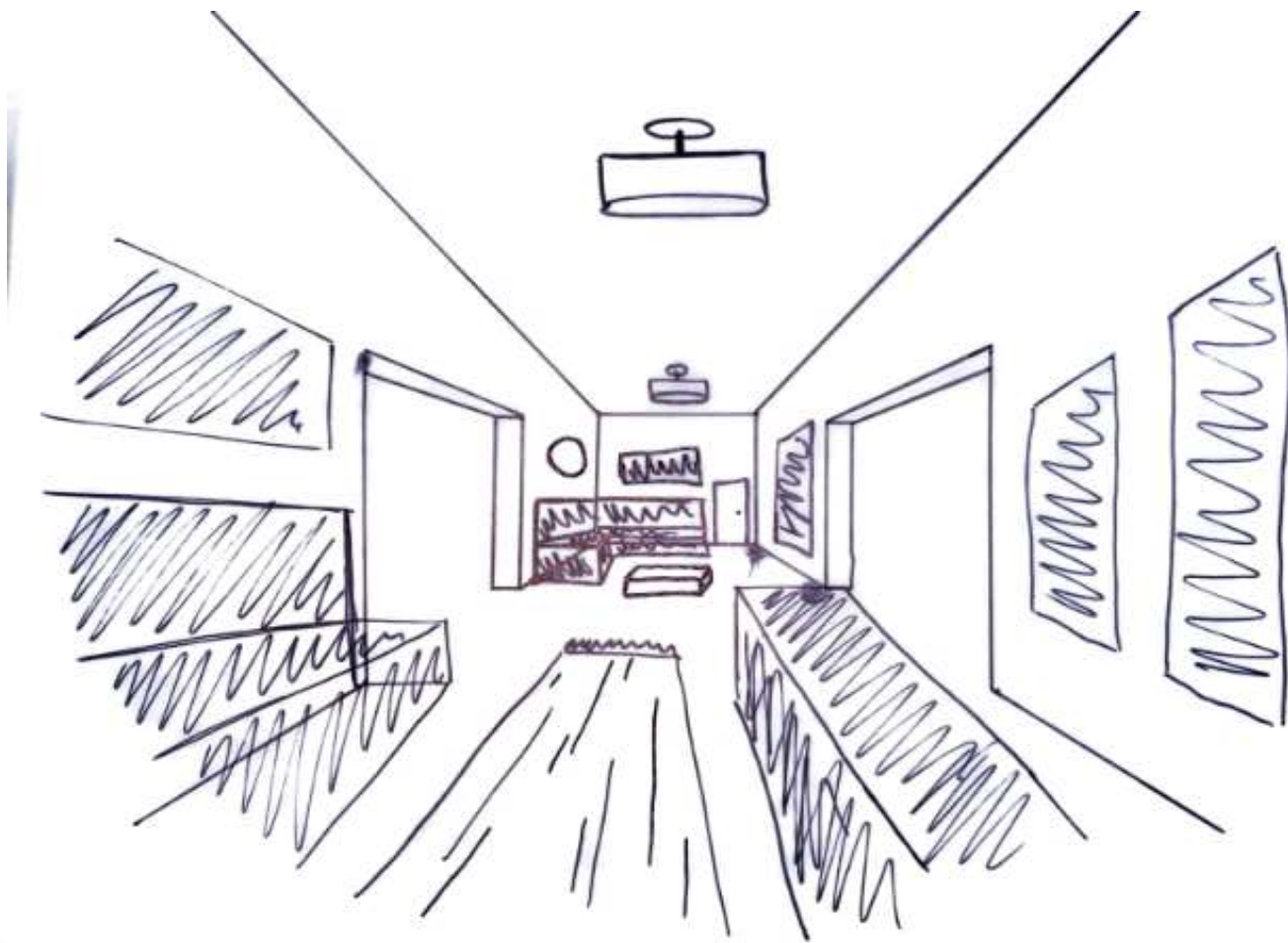

Assignment 10:  
Design Synthesis  
Studies- Service  
Counter

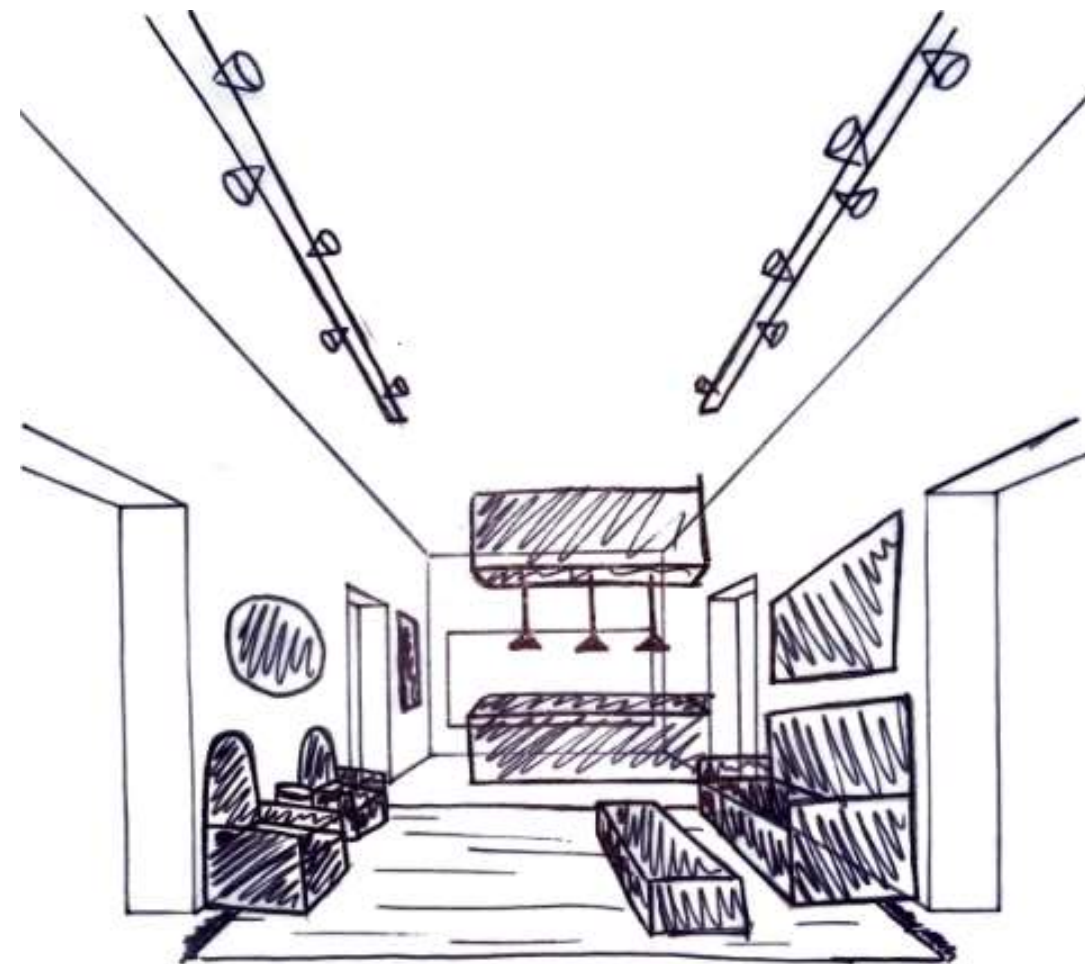
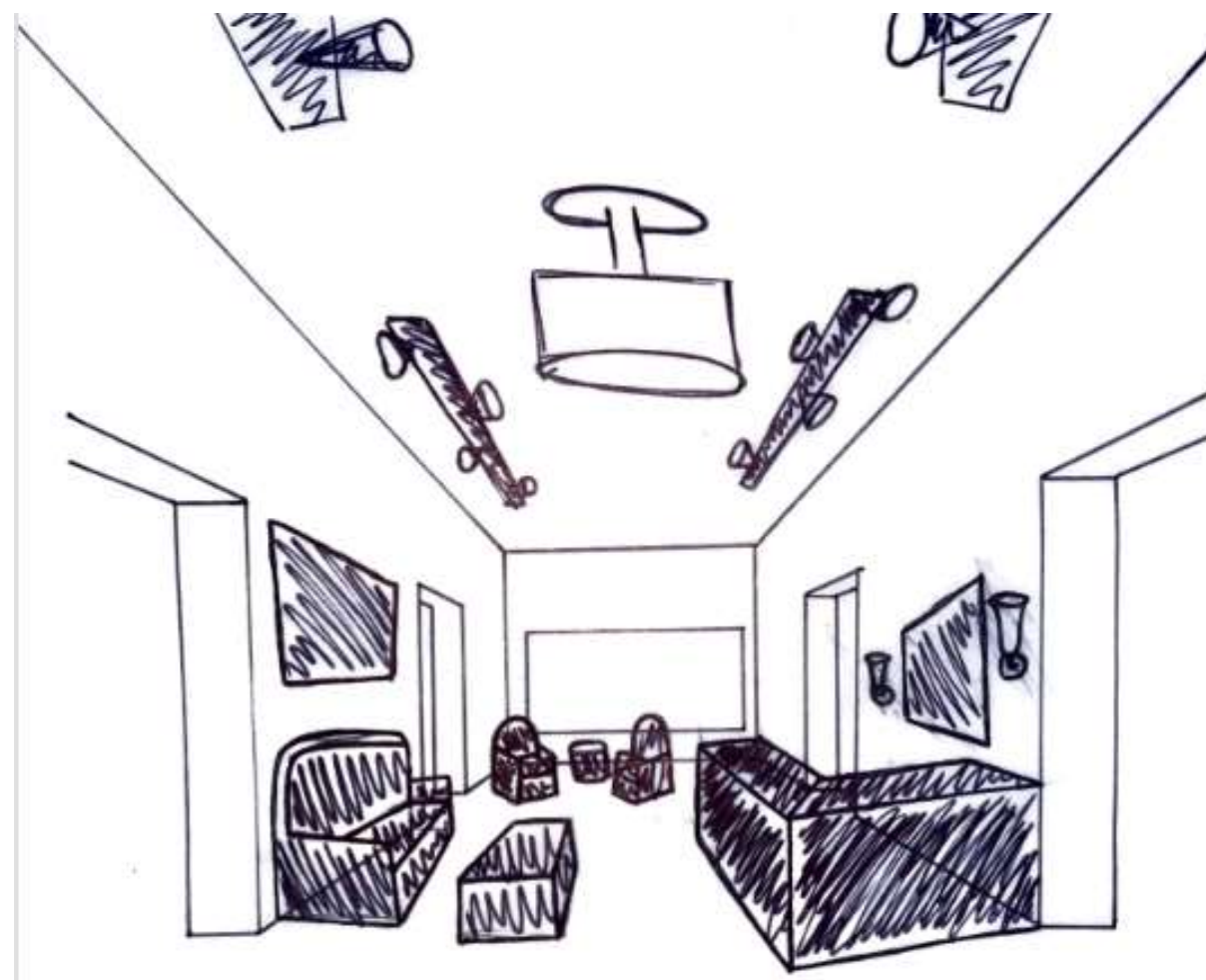
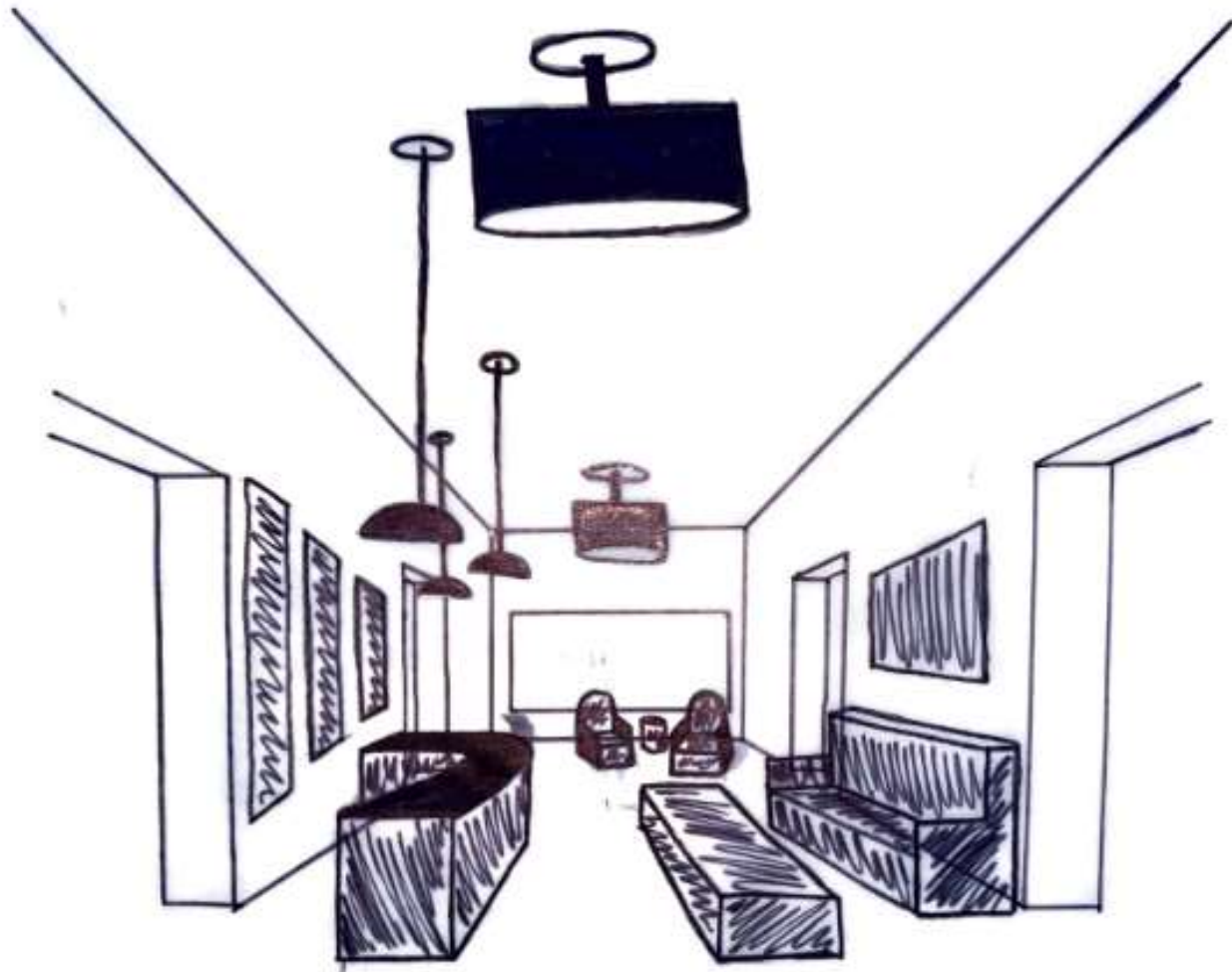

Assignment 10:  
Design Synthesis  
Studies- Open  
Work Area

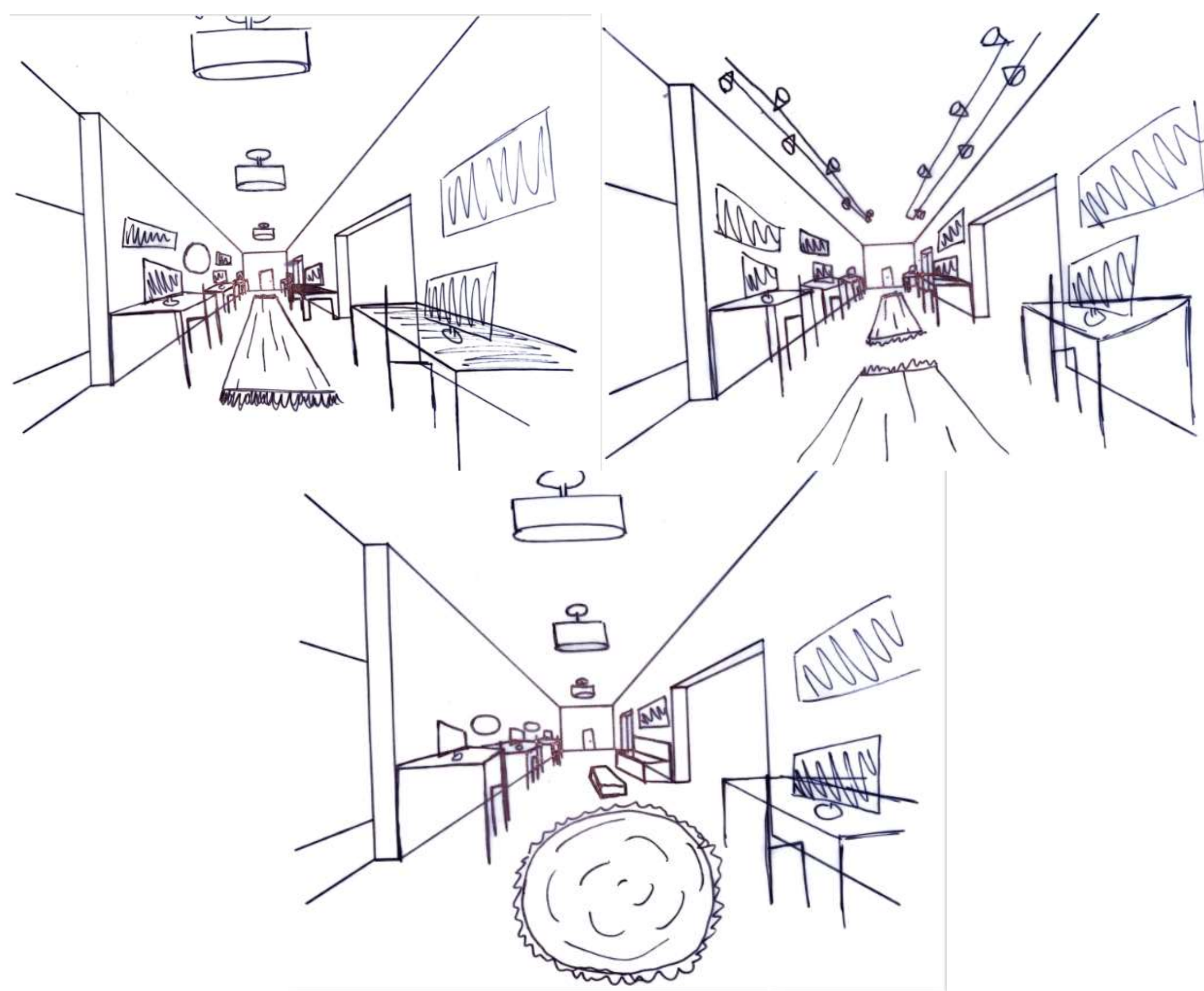

Assignment 11:  
Furniture and  
Finish Palette-  
Option A



Assignment 11:  
Furniture and  
Finish Palette-  
Option B



Assignment 12:  
Lighting Model

