

Ductwork

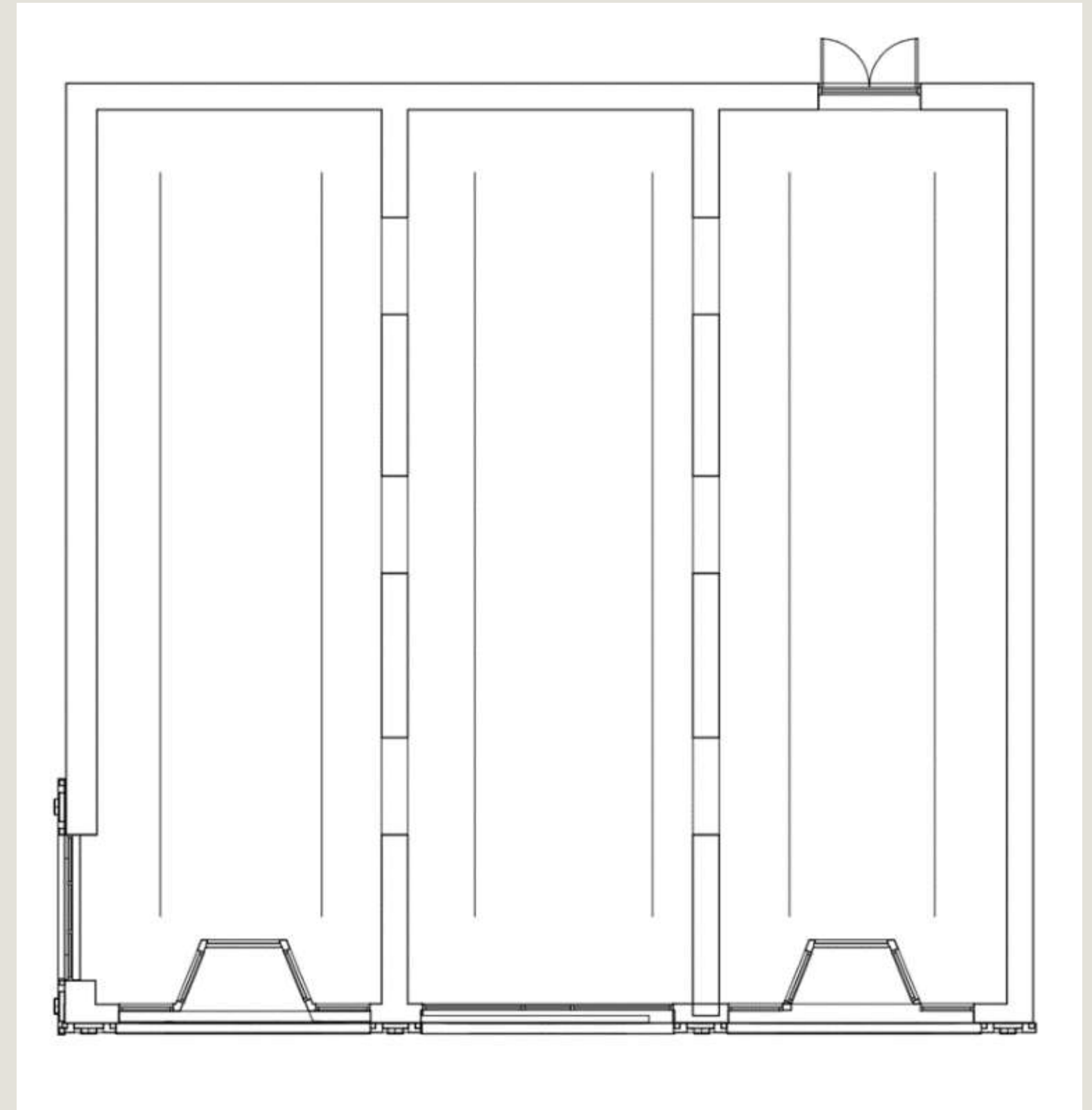

Space Plan Options

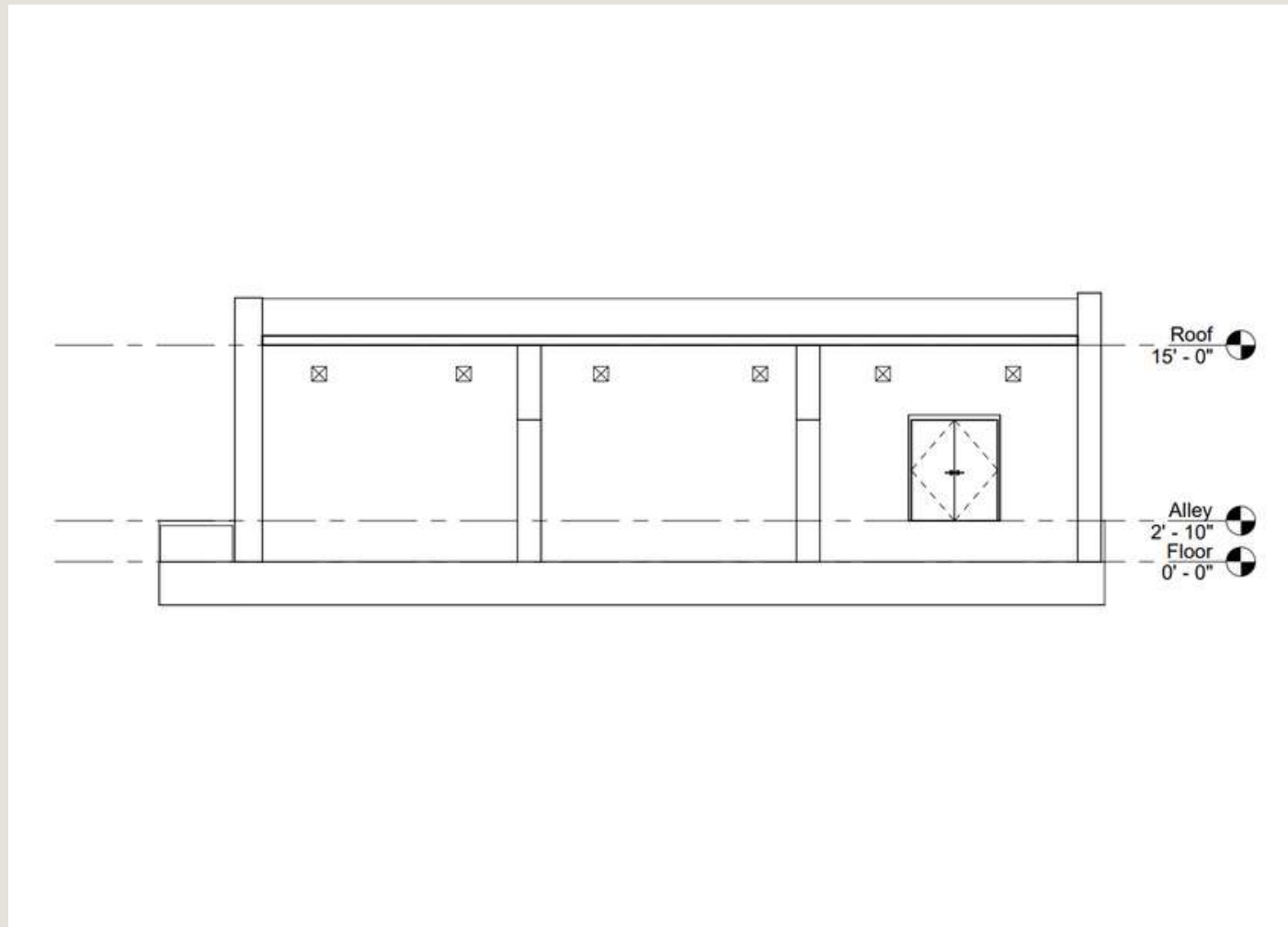

Space Plan Options

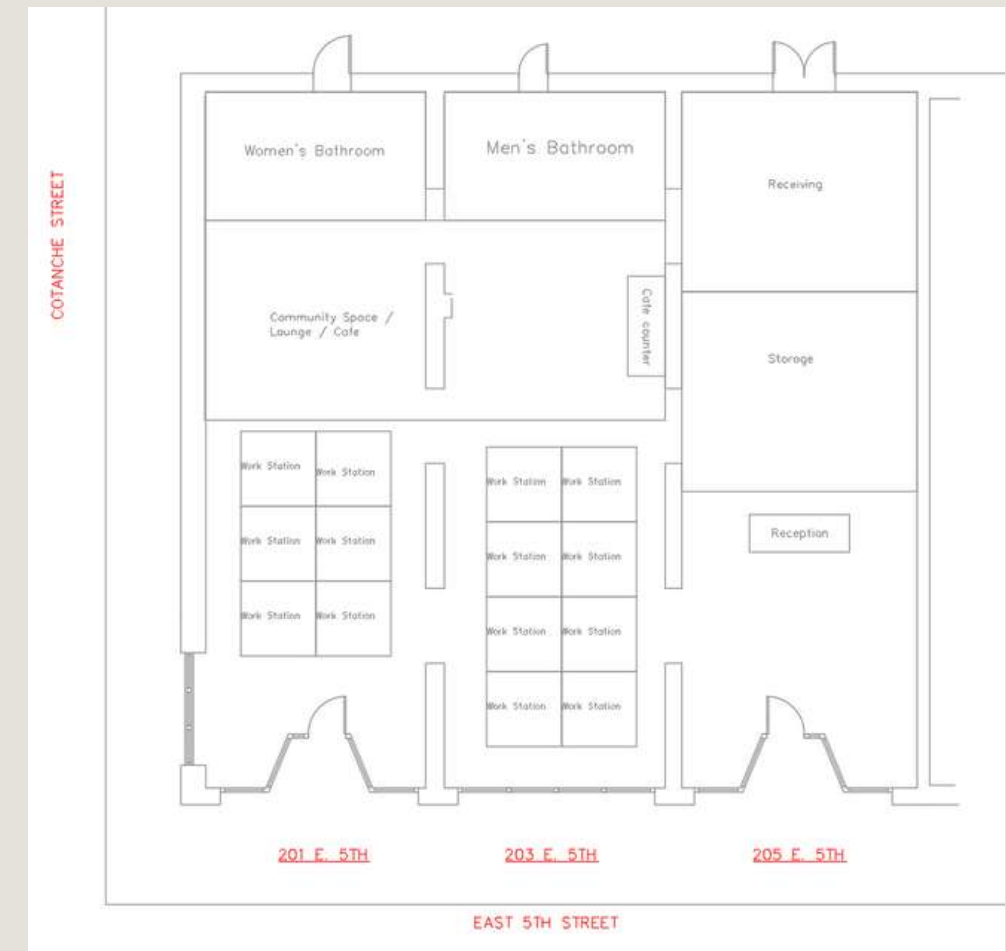
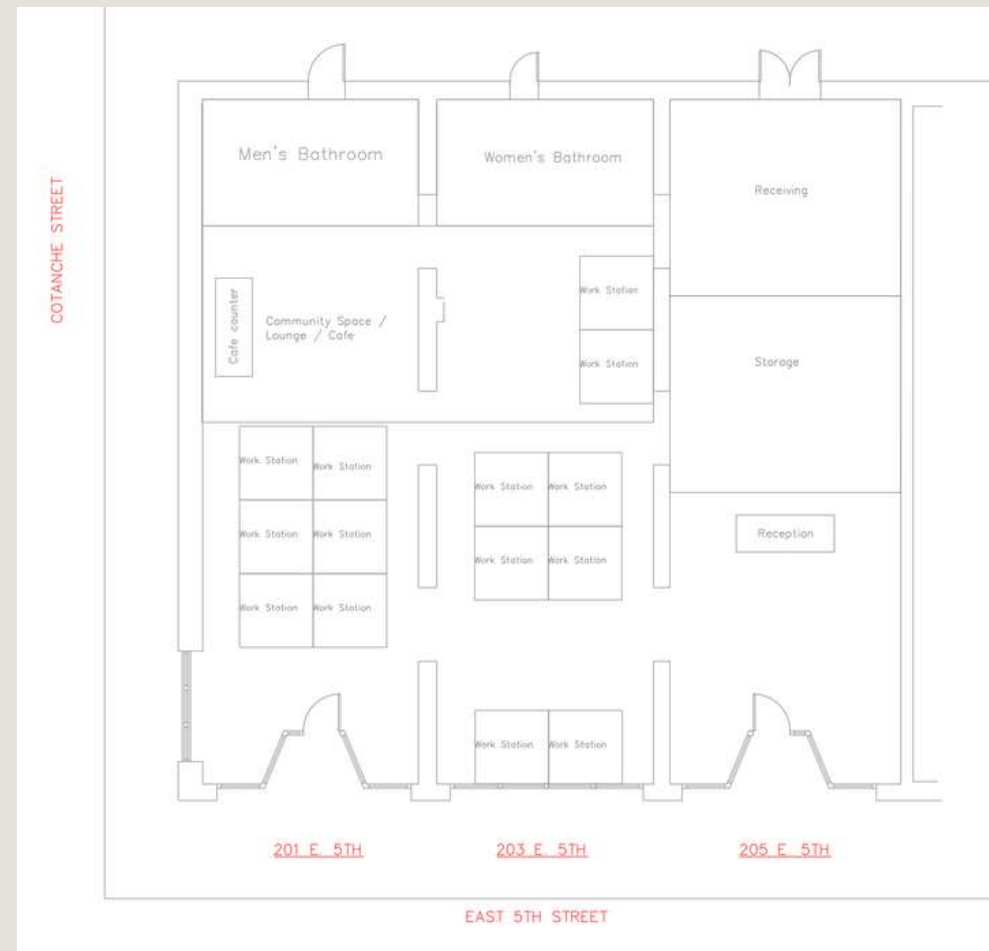
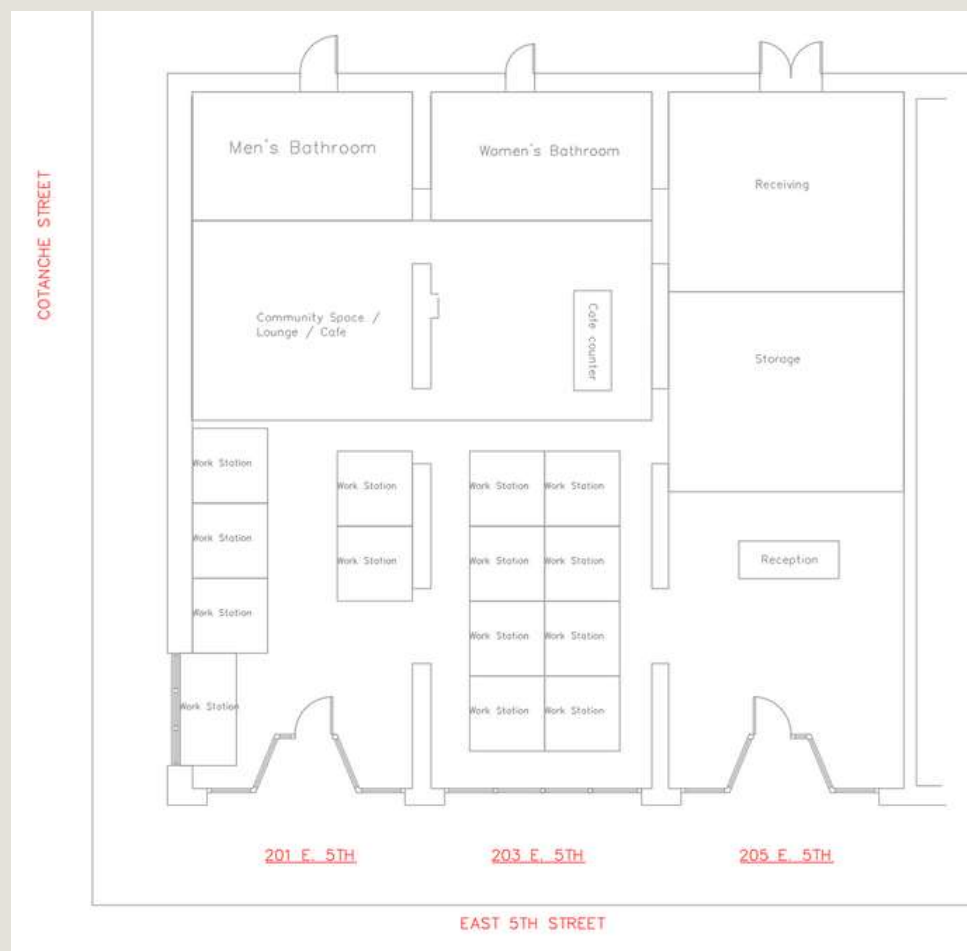

Ceiling 1

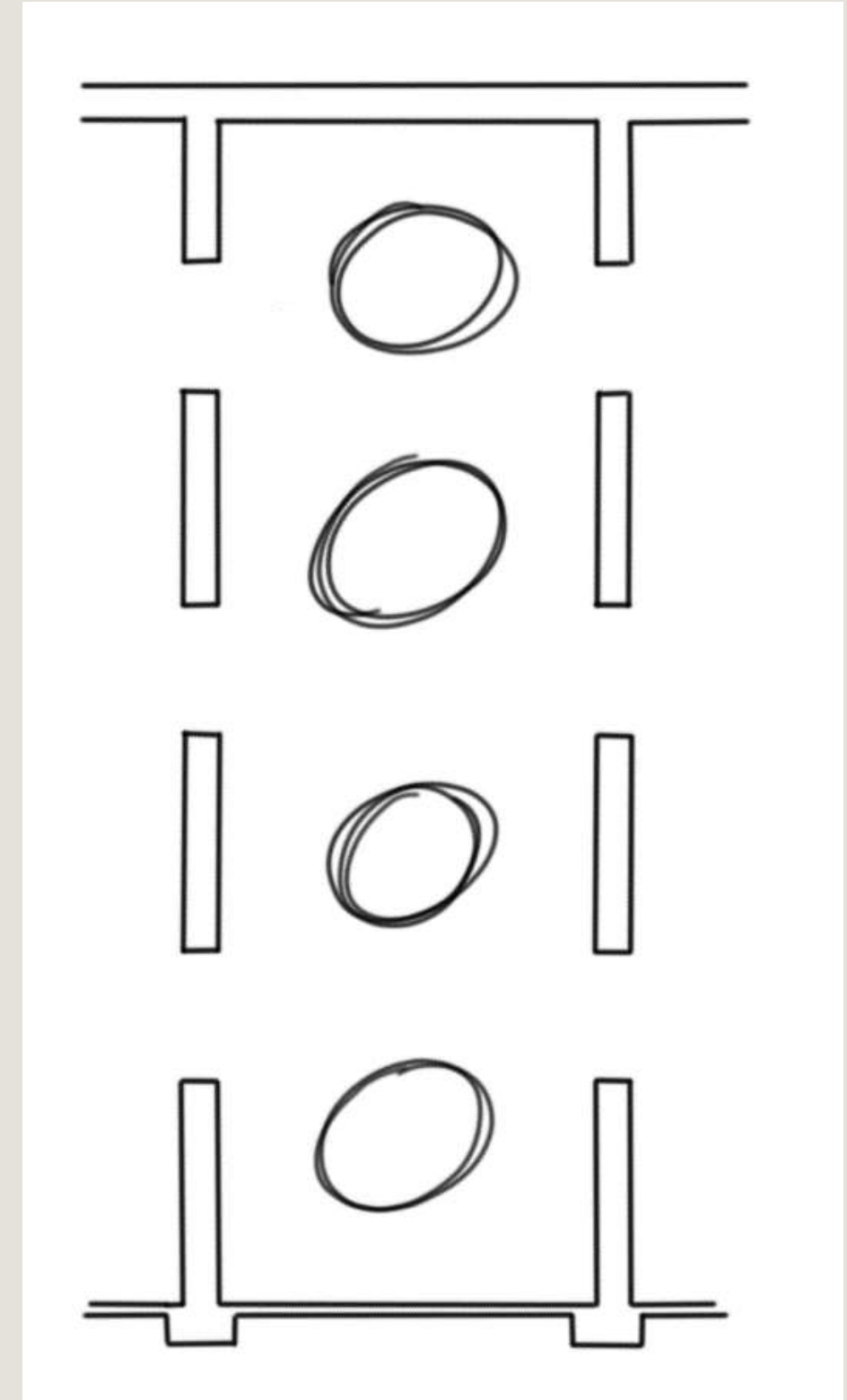
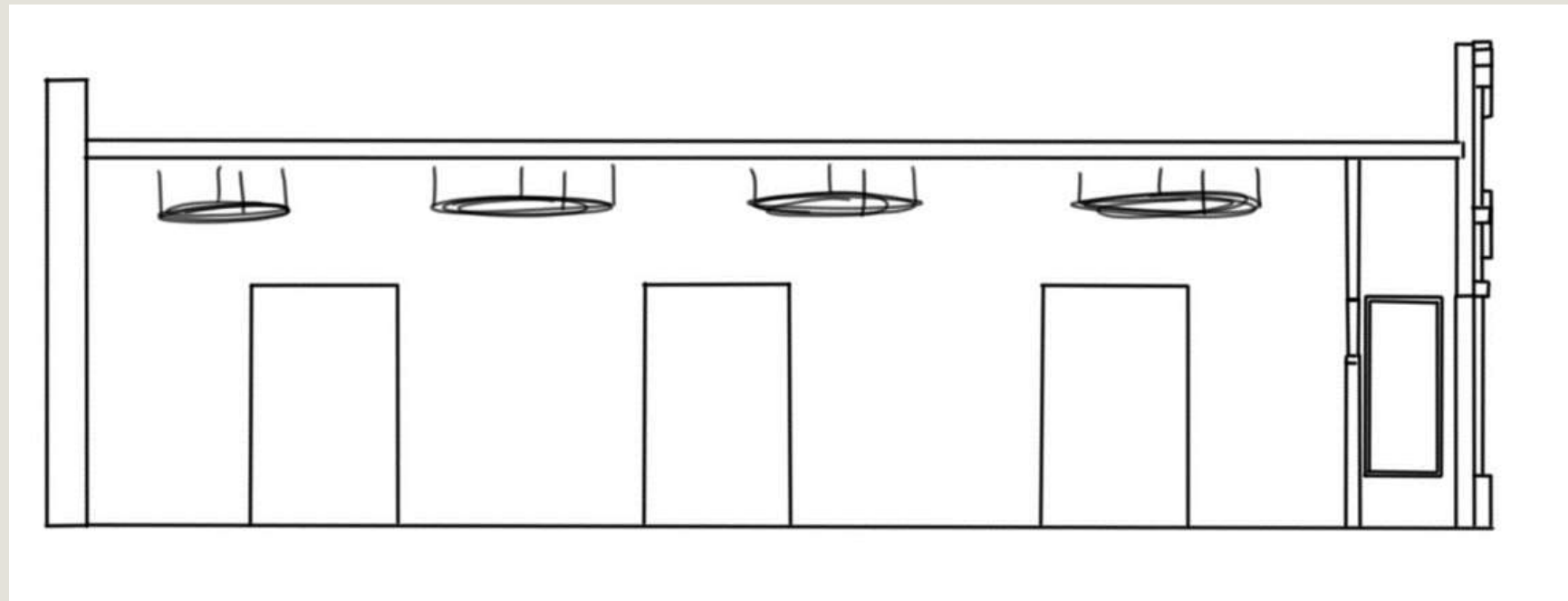
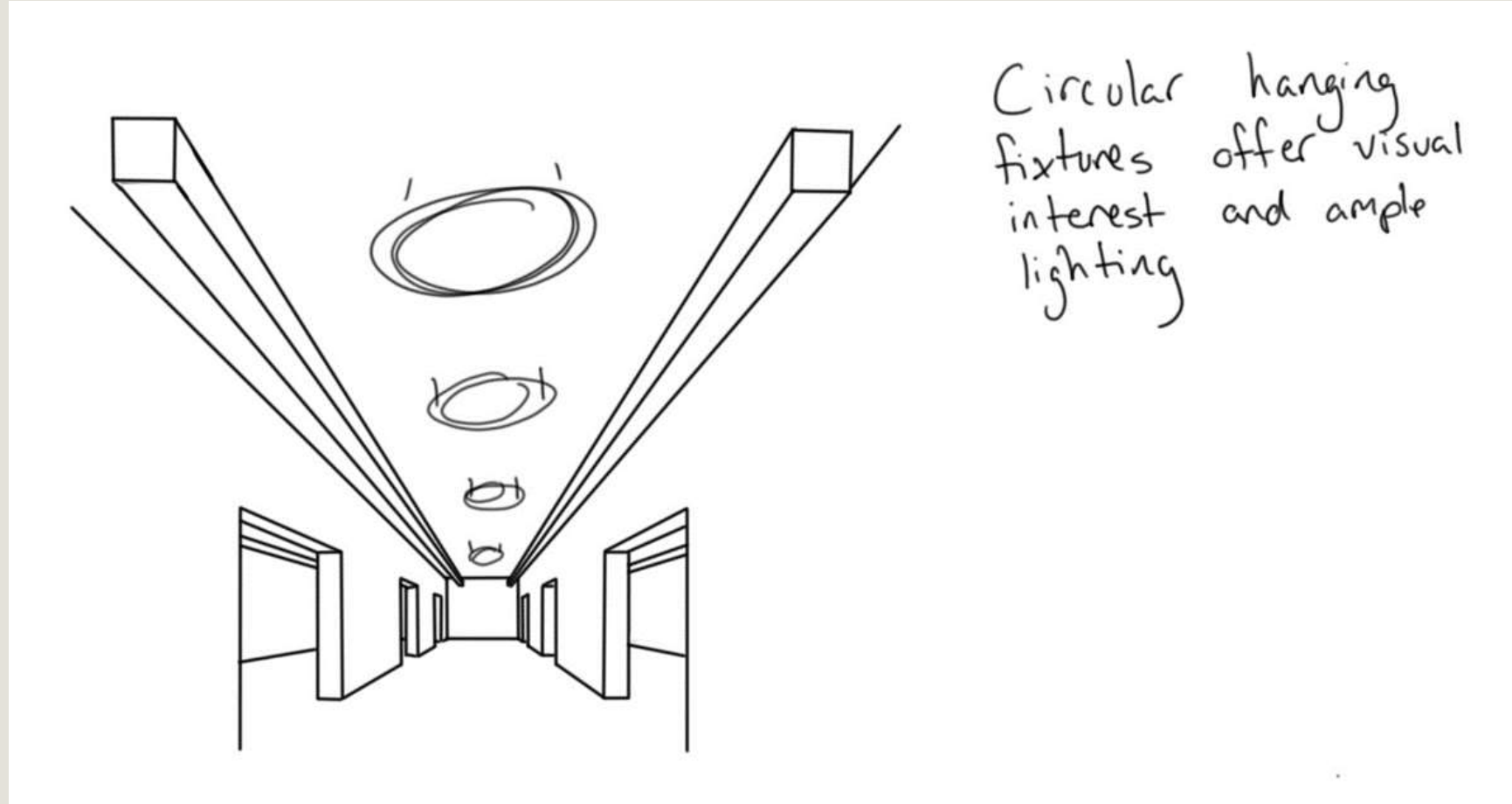

Ceiling 2

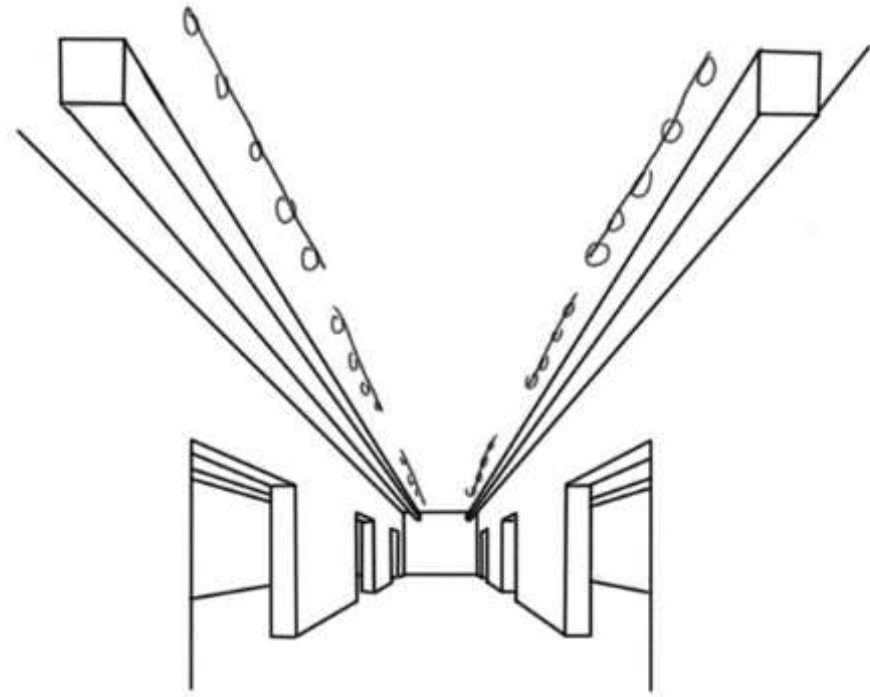

Adjustable track
lights ensure all areas
are adequately lit

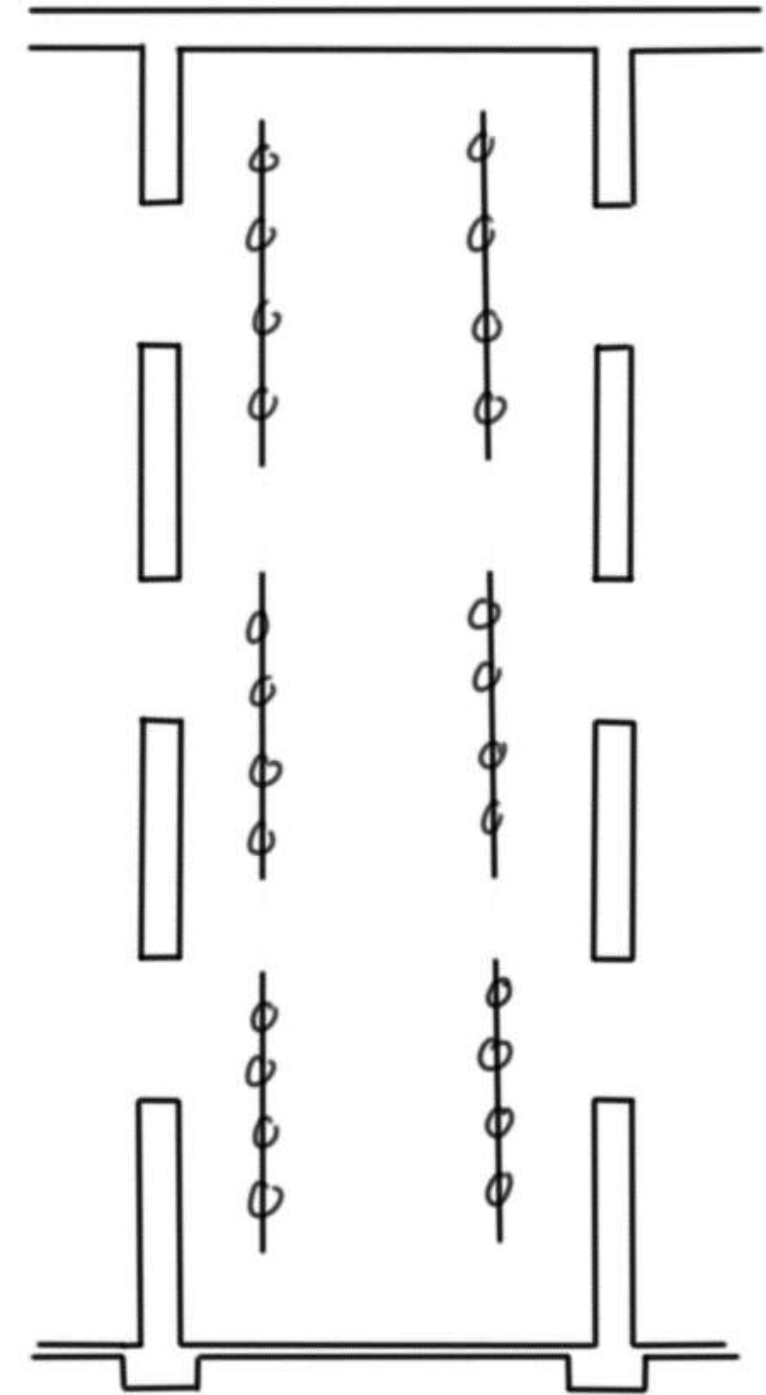
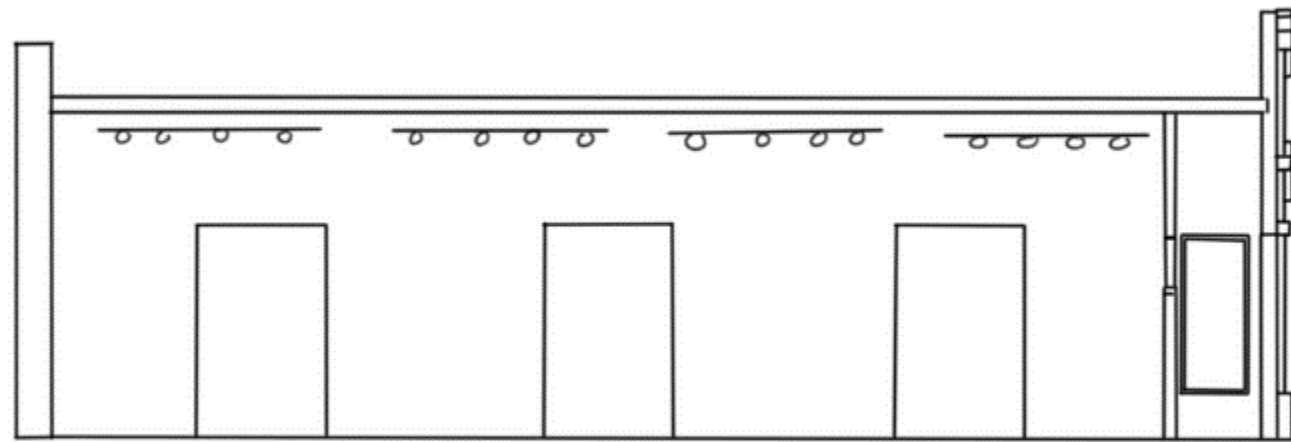

Entry 1

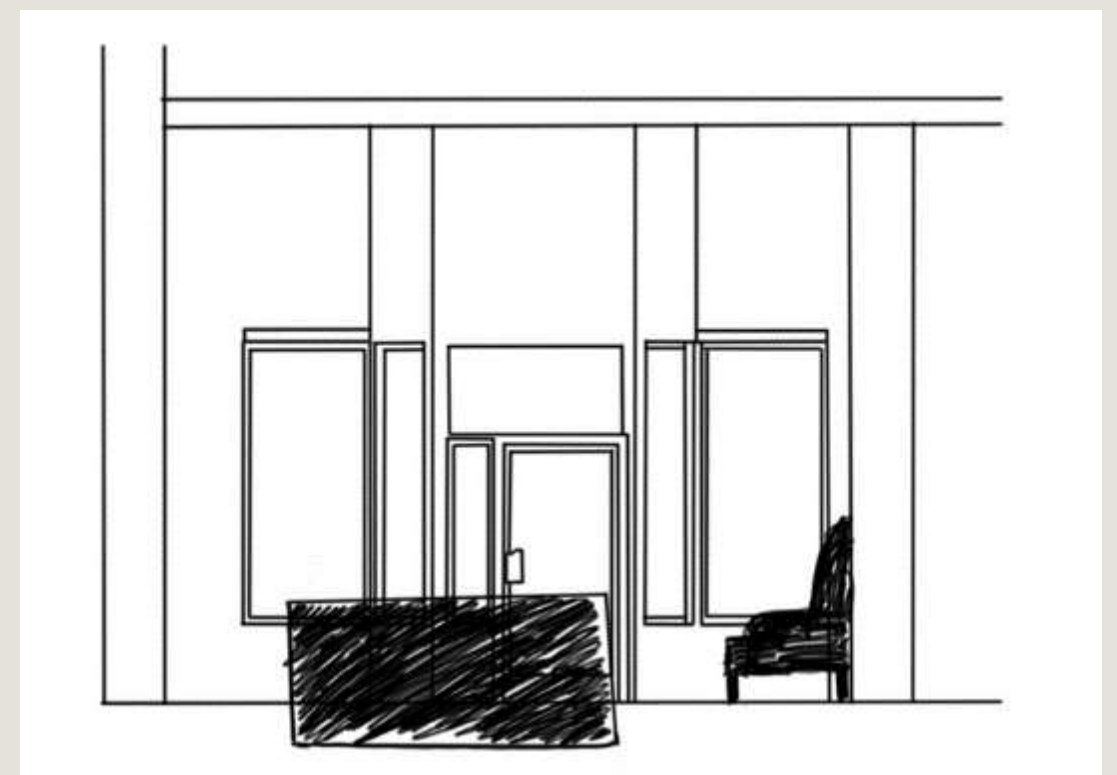
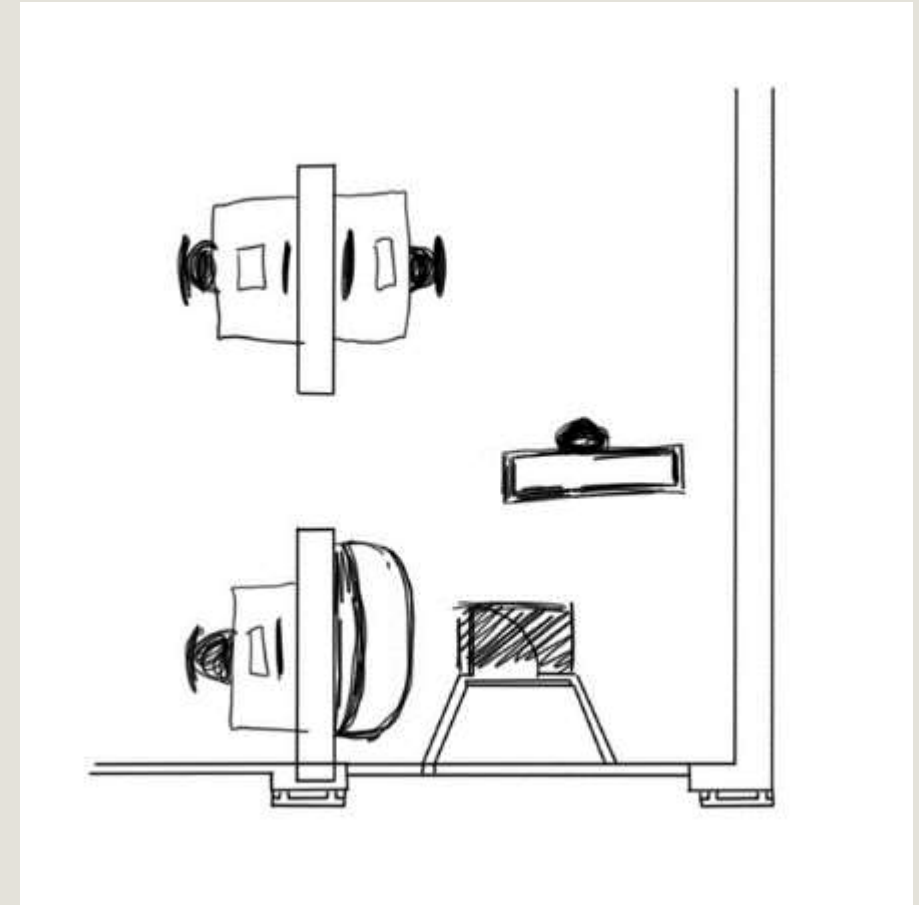

Entry 2

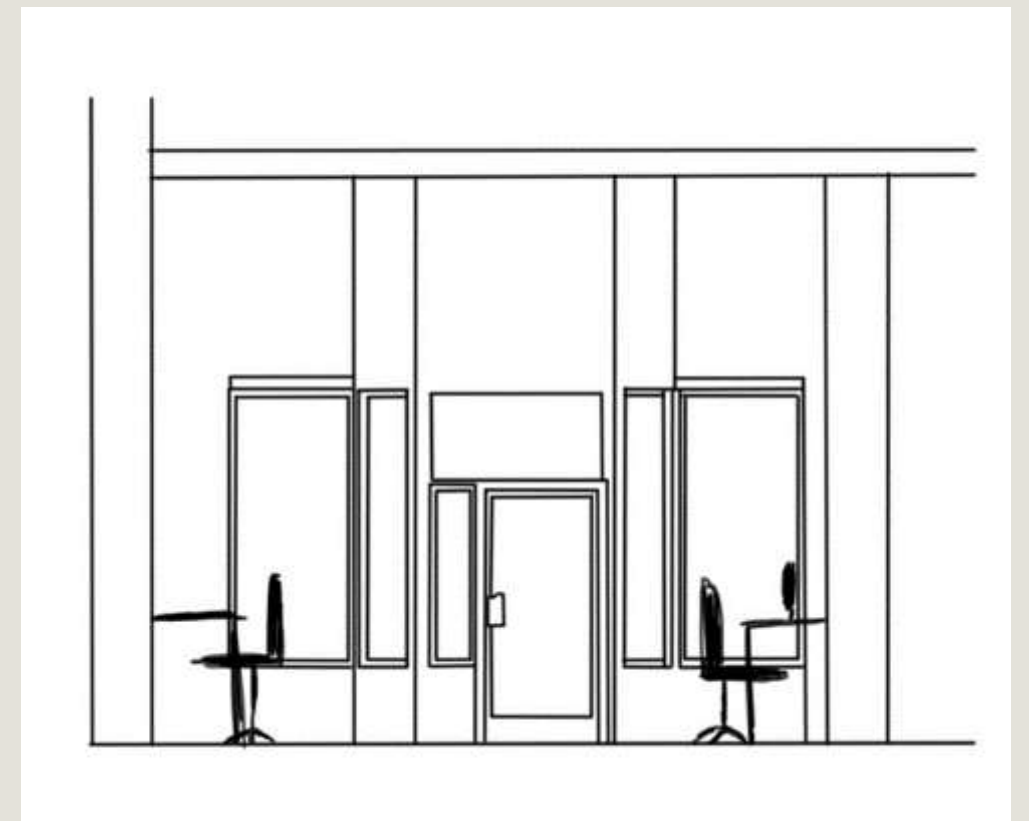
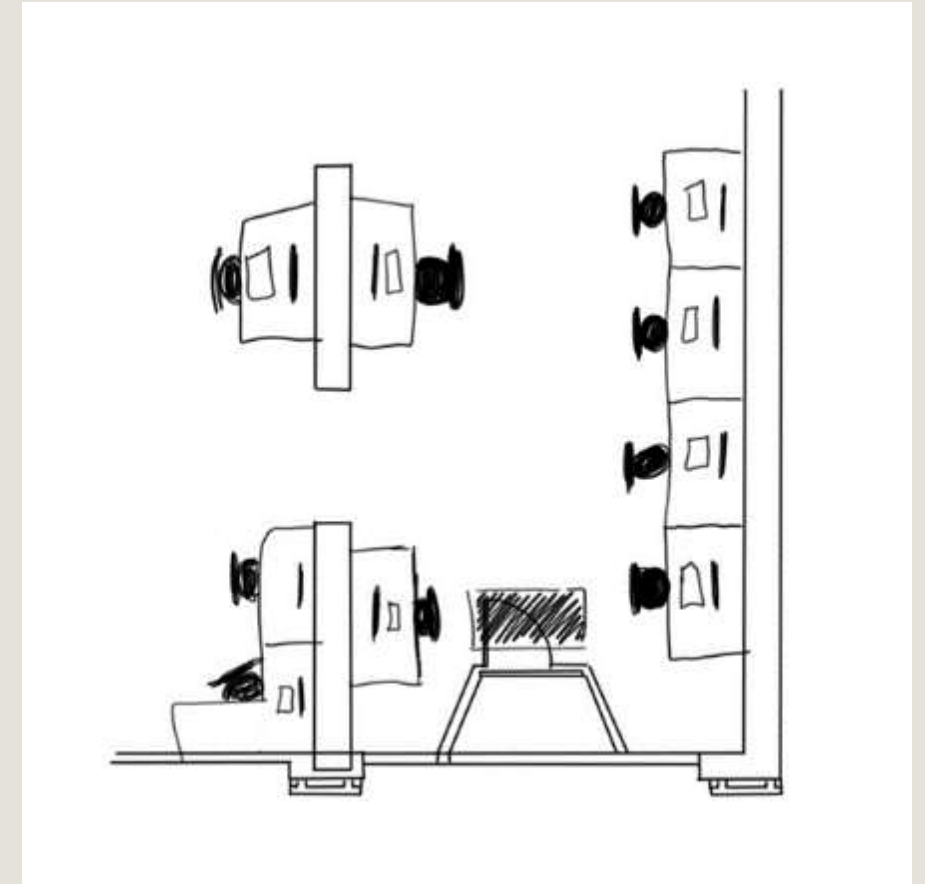

Exploration 1

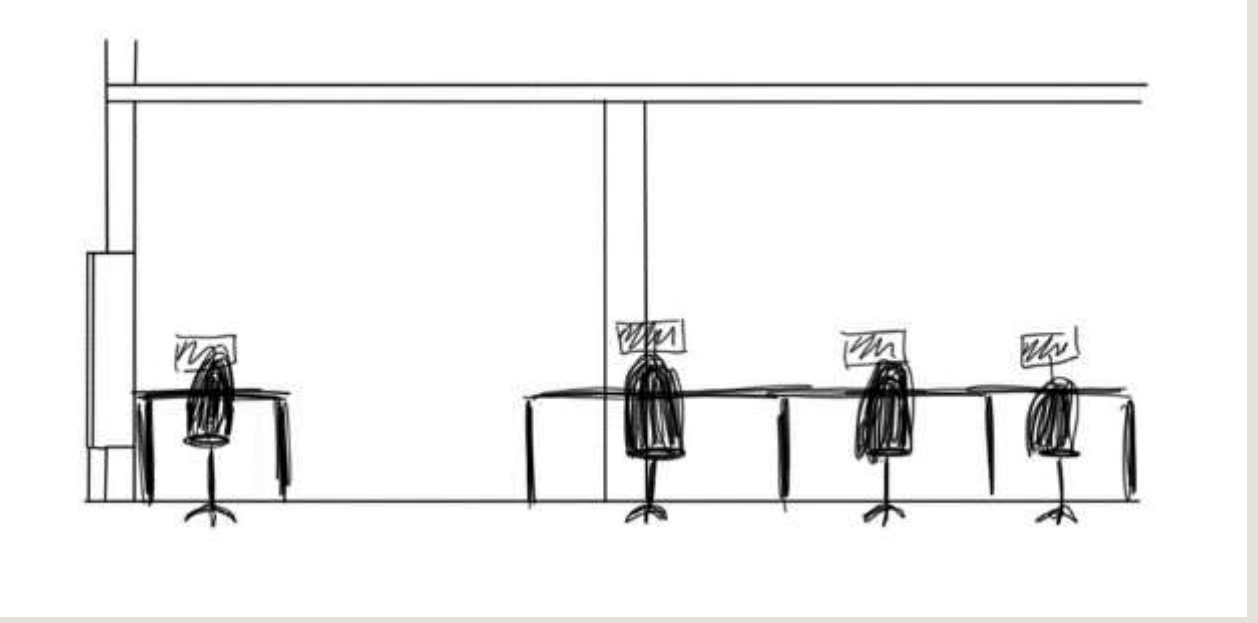
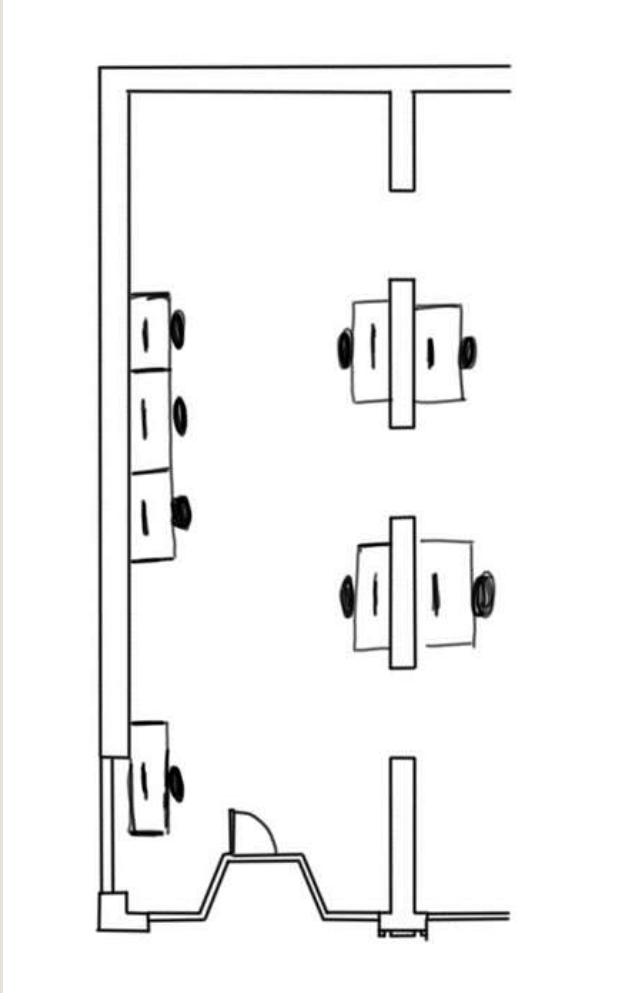
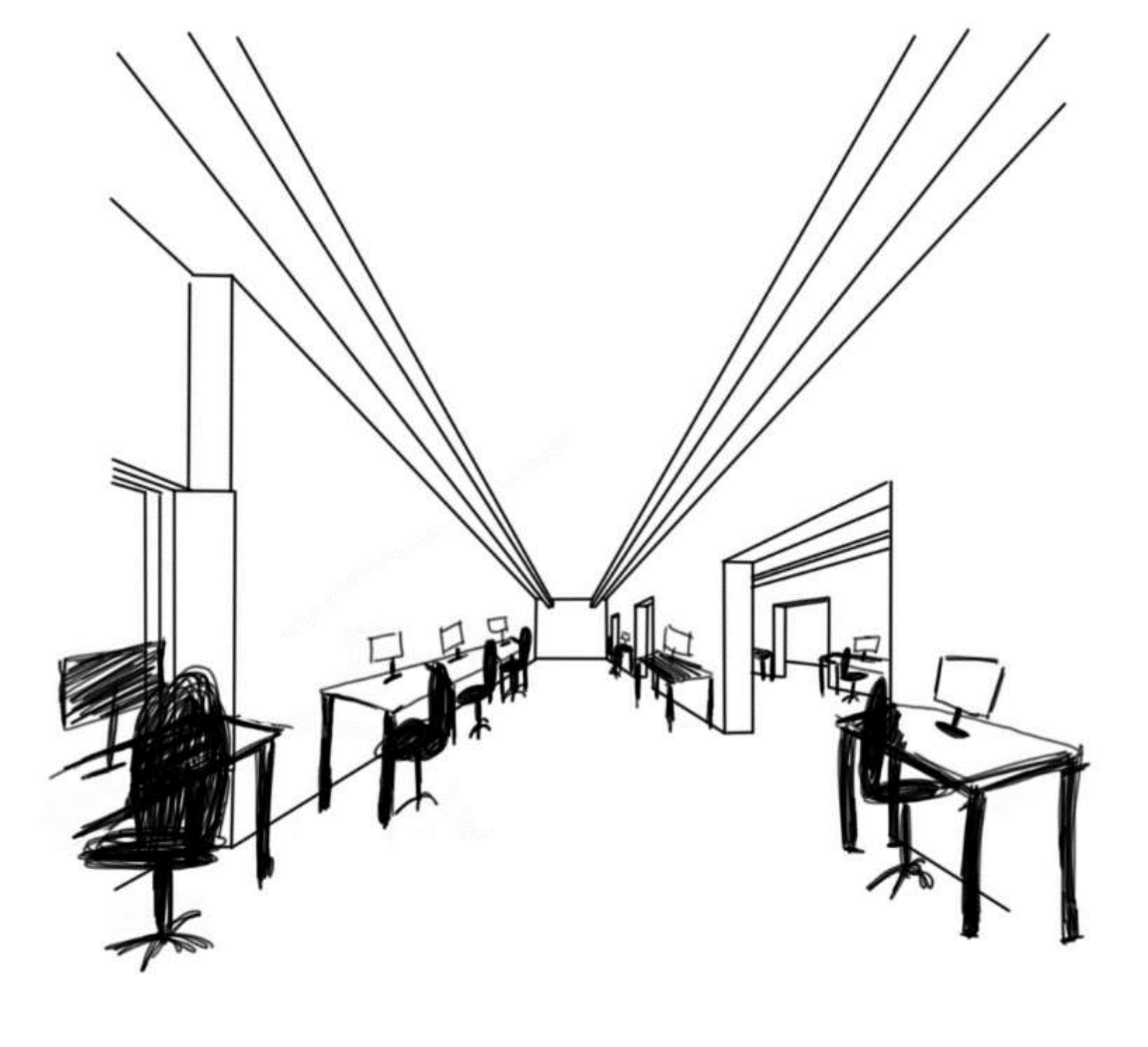

Exploration 2

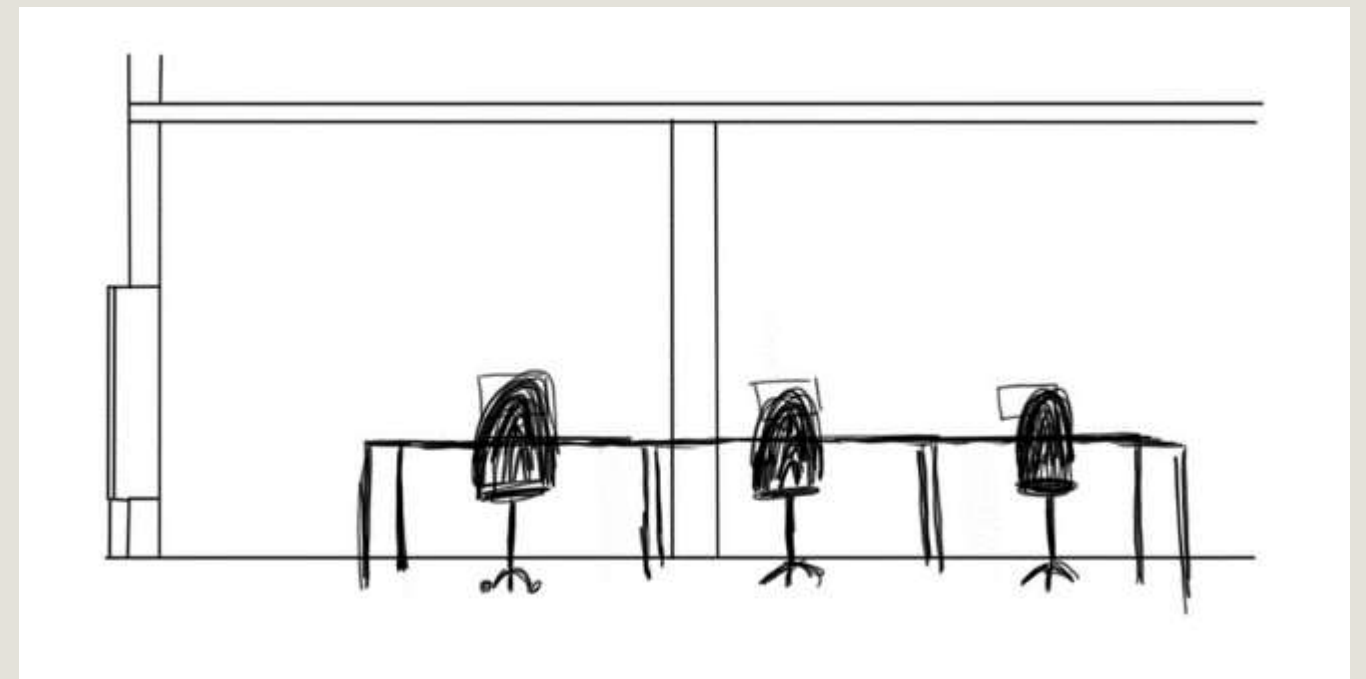
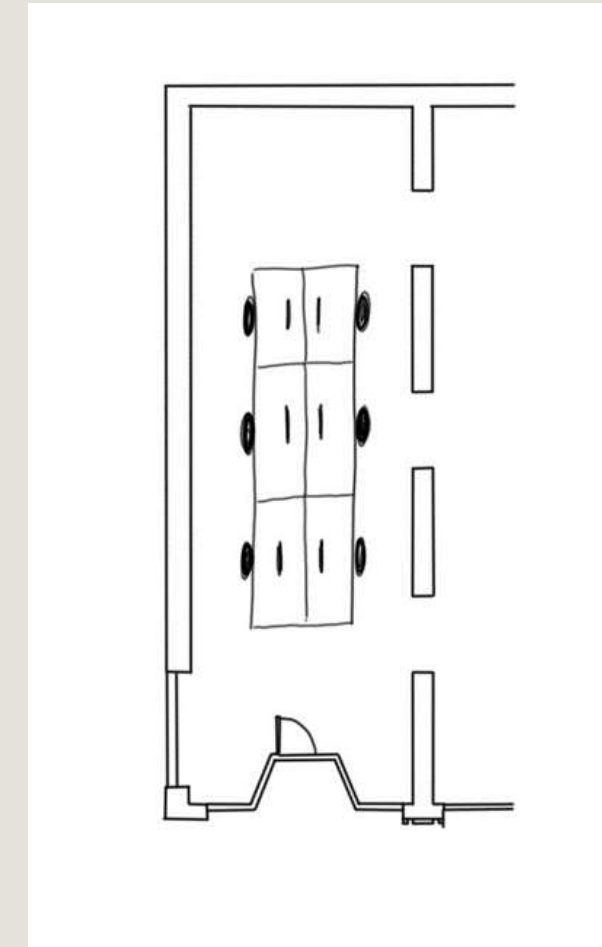

Support Spaces 1

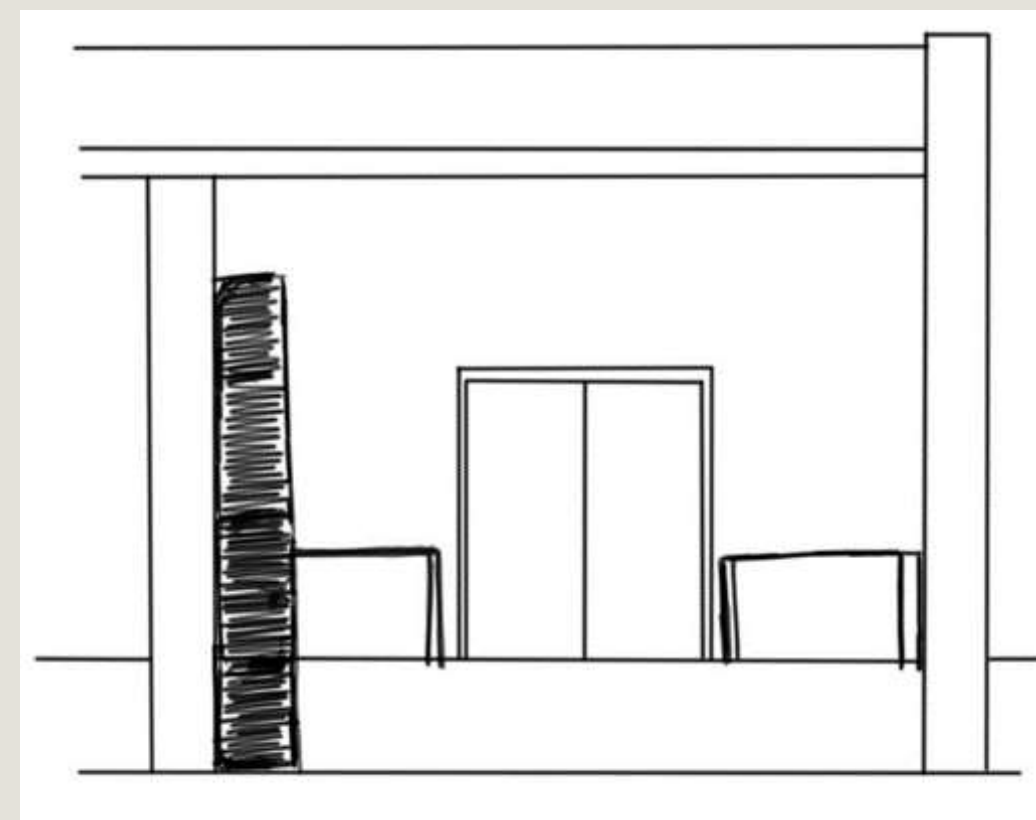
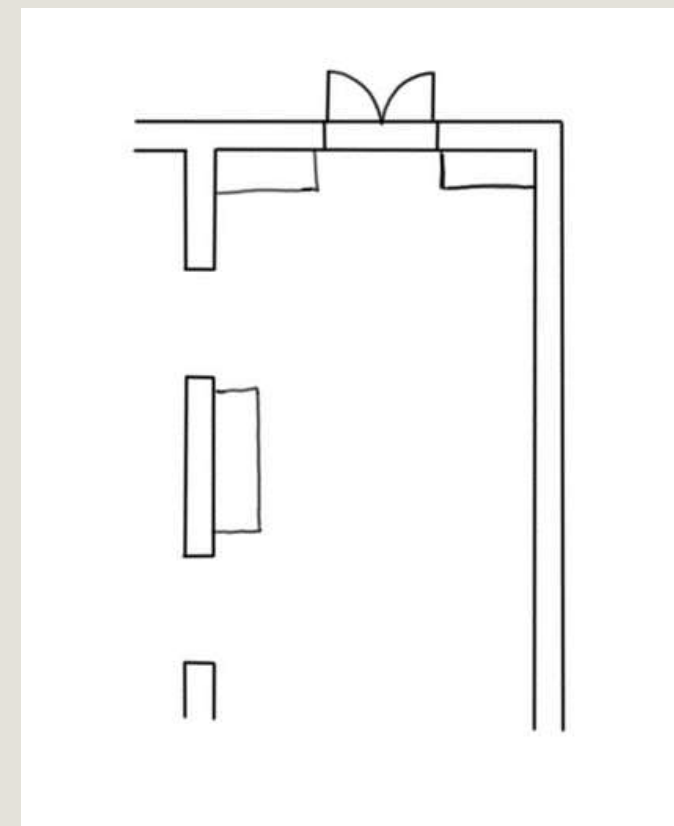
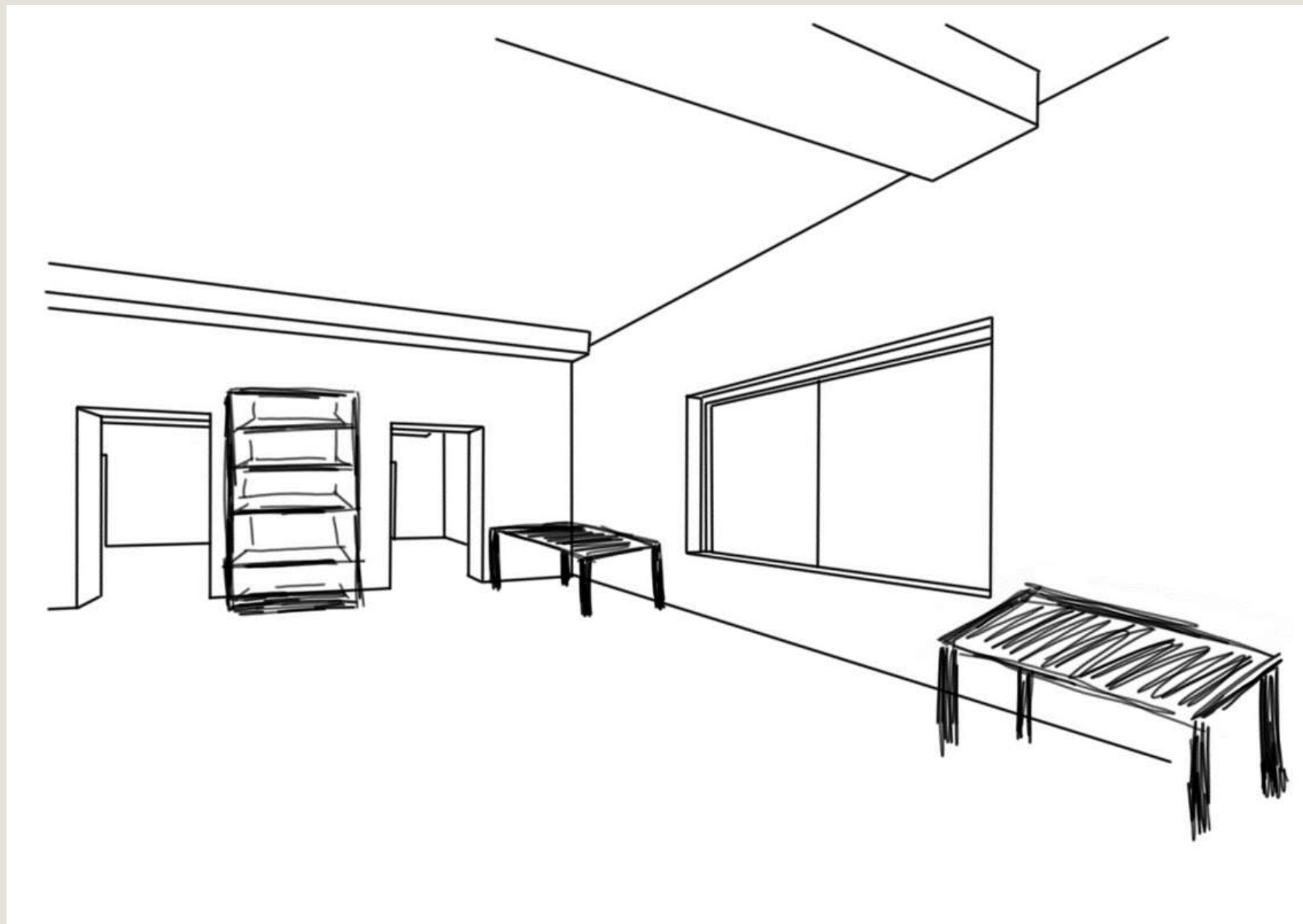

Support Spaces 2

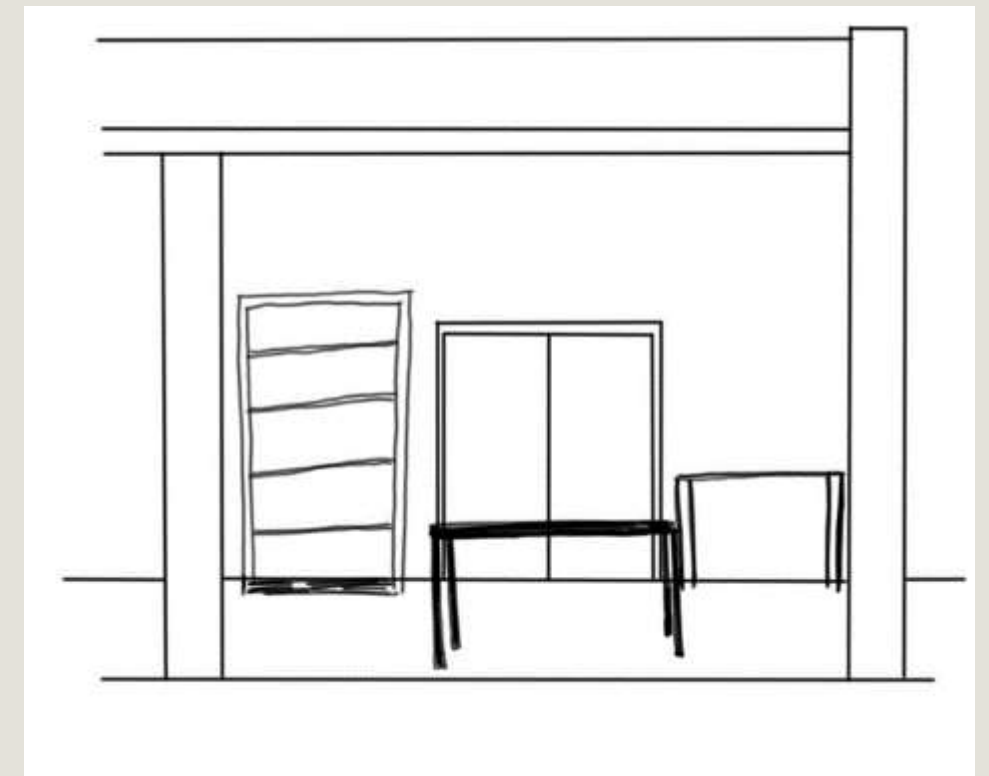
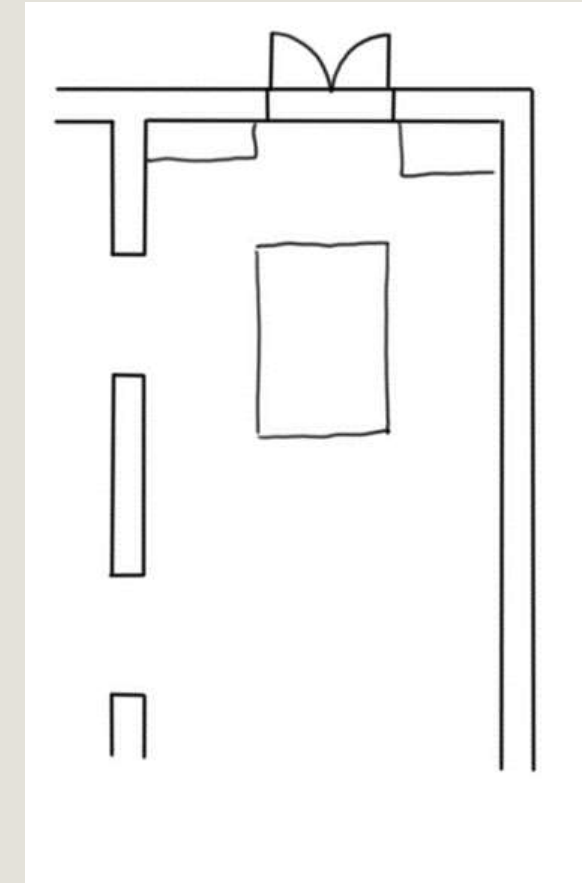
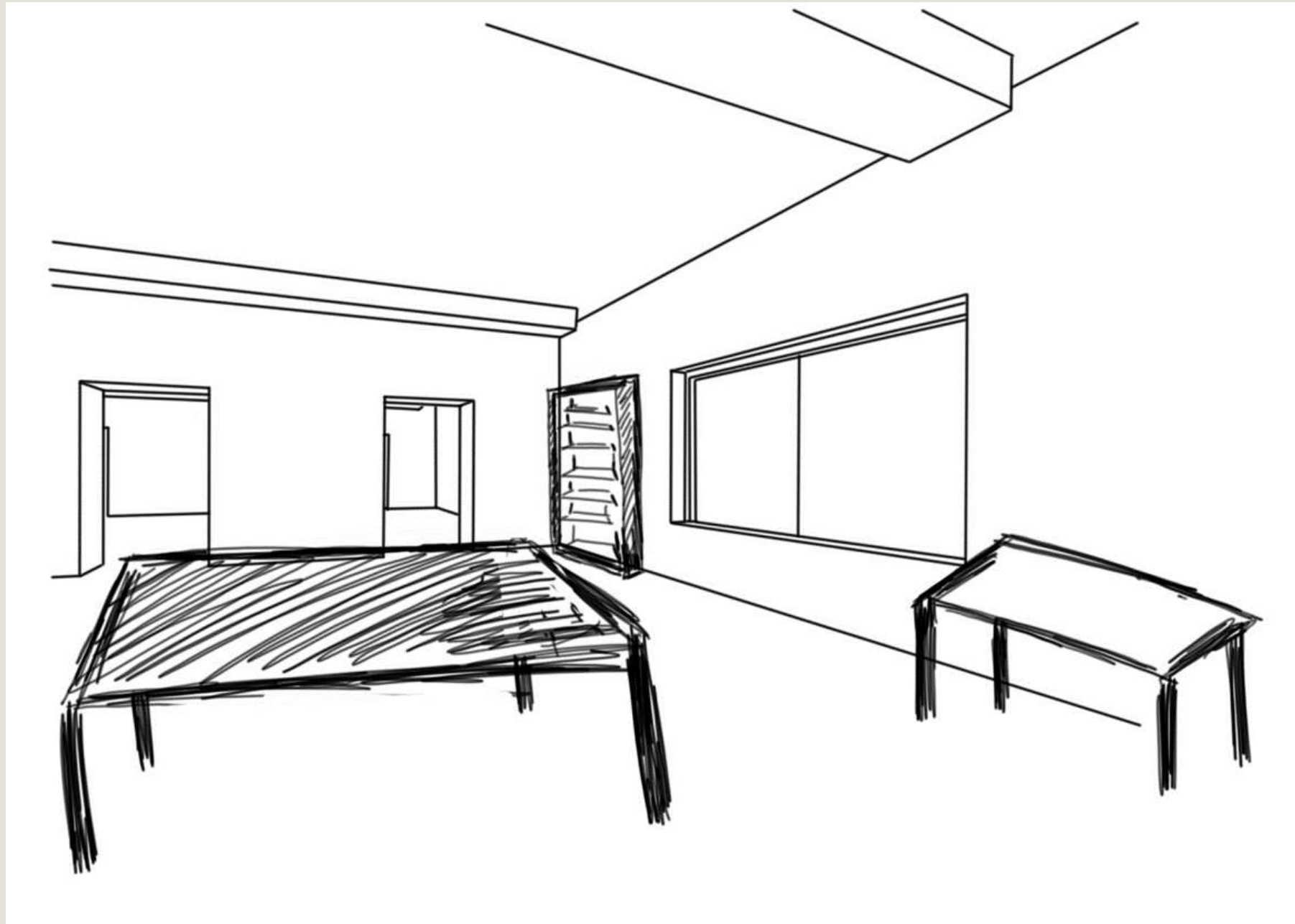

Assignment 10 - Entry/Reception

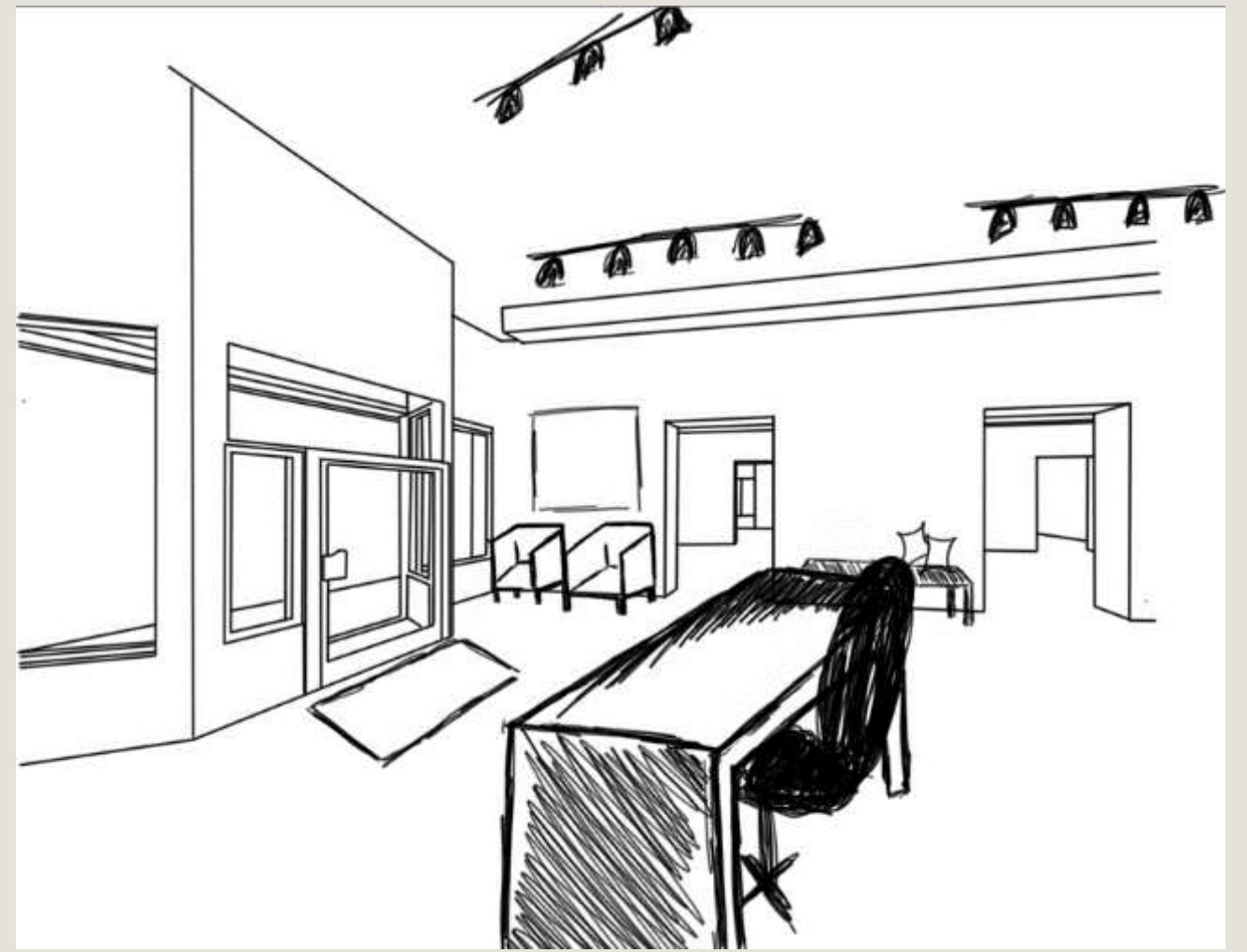

Assignment 10 - Lounge

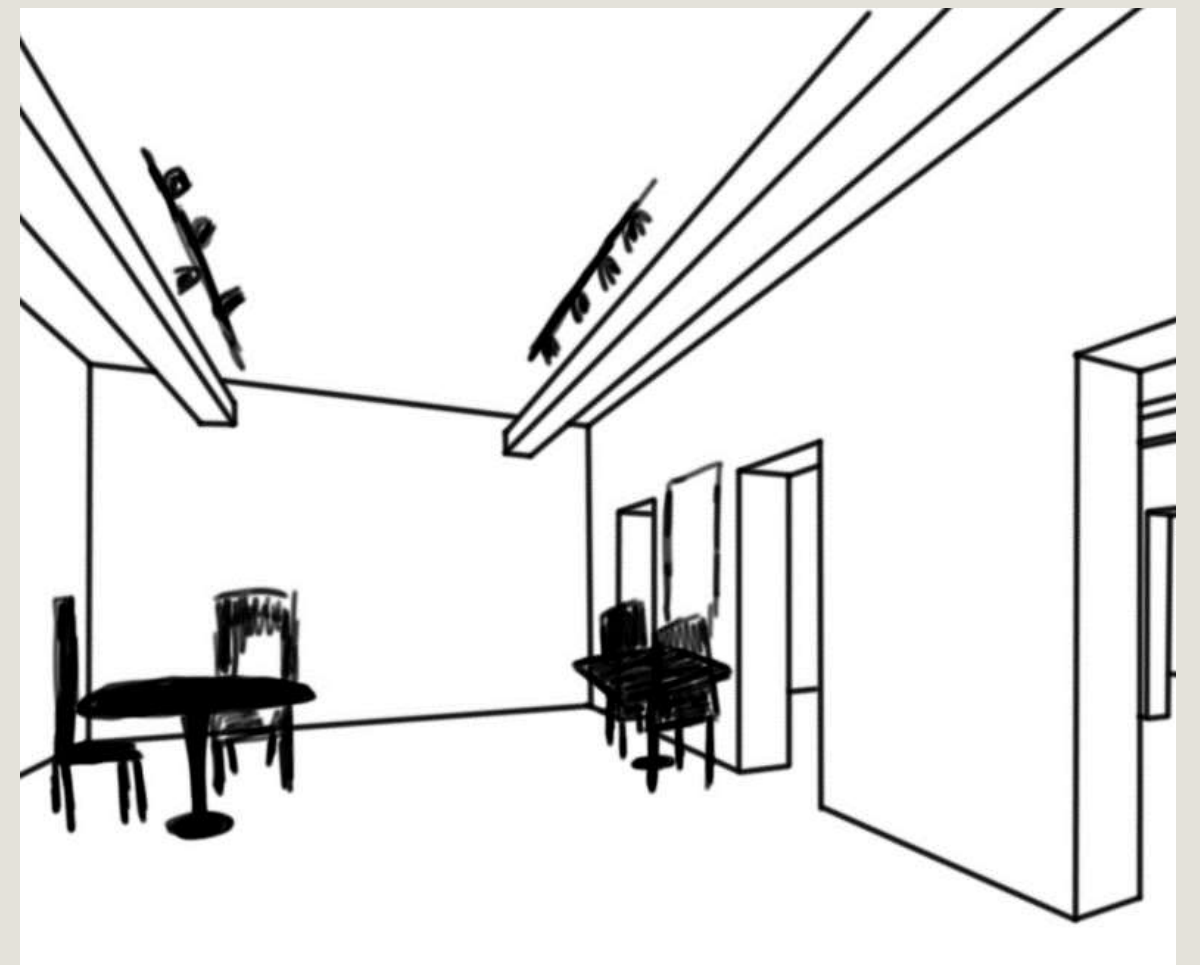
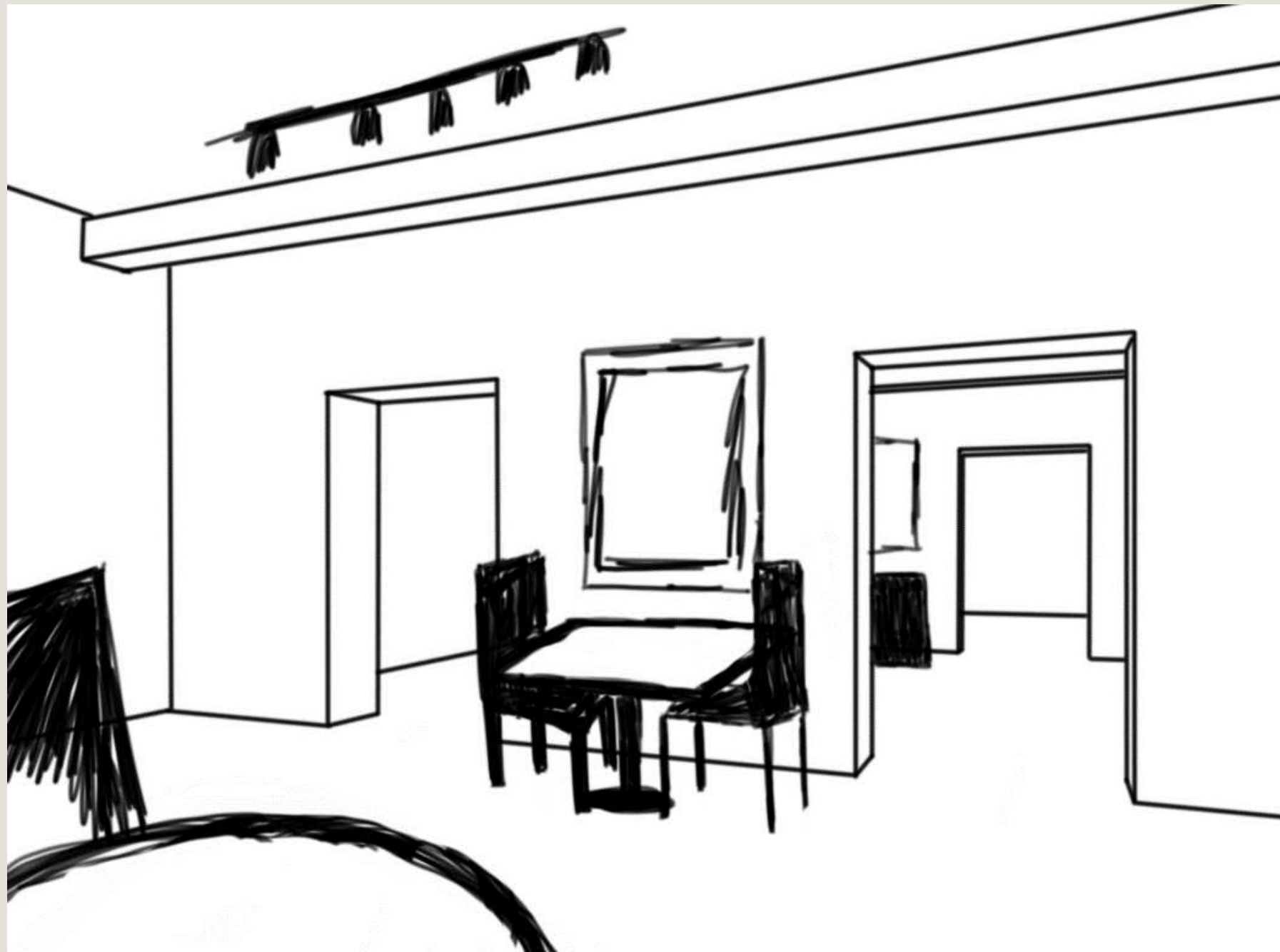

Assignment 10 - Service Counter

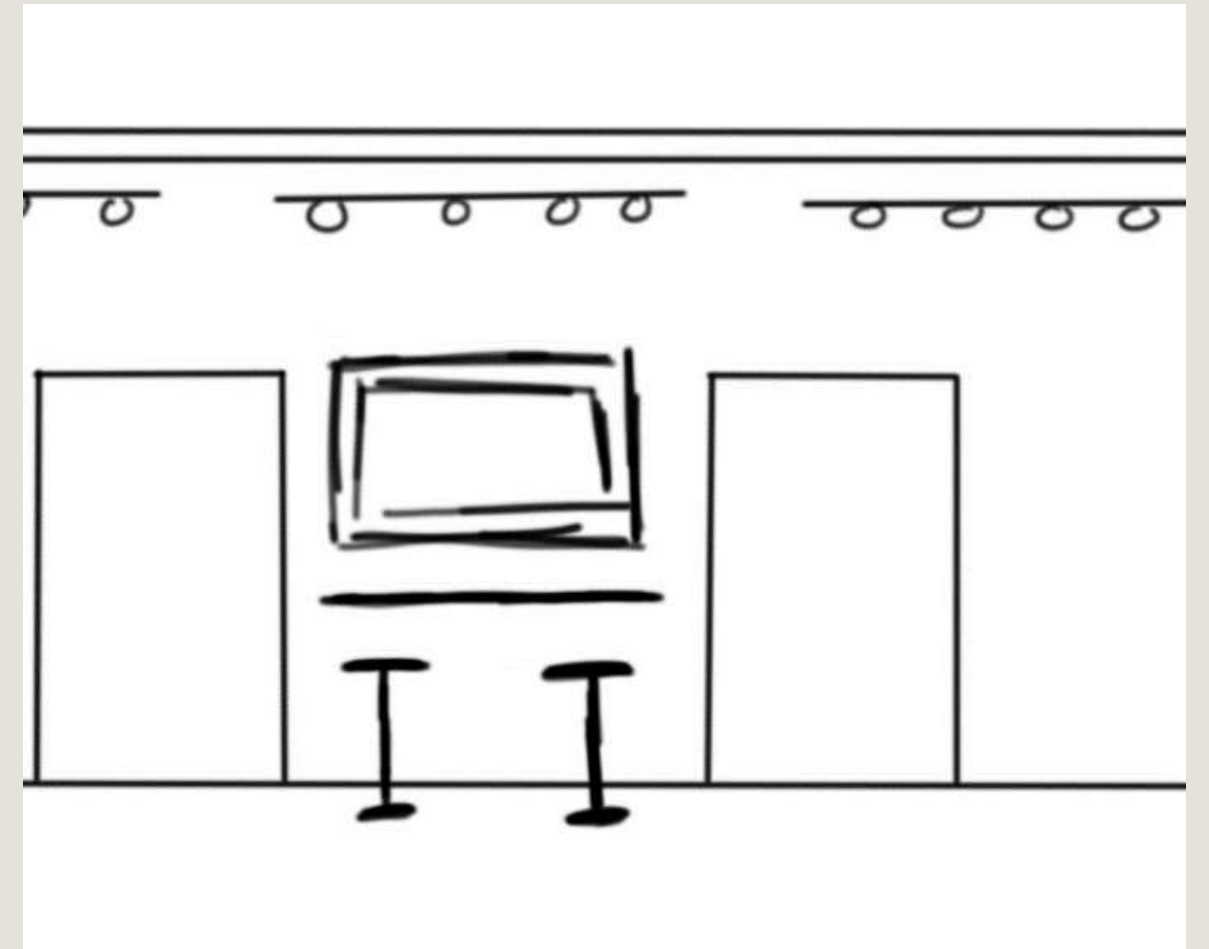

Assignment 10 - Open Work Area

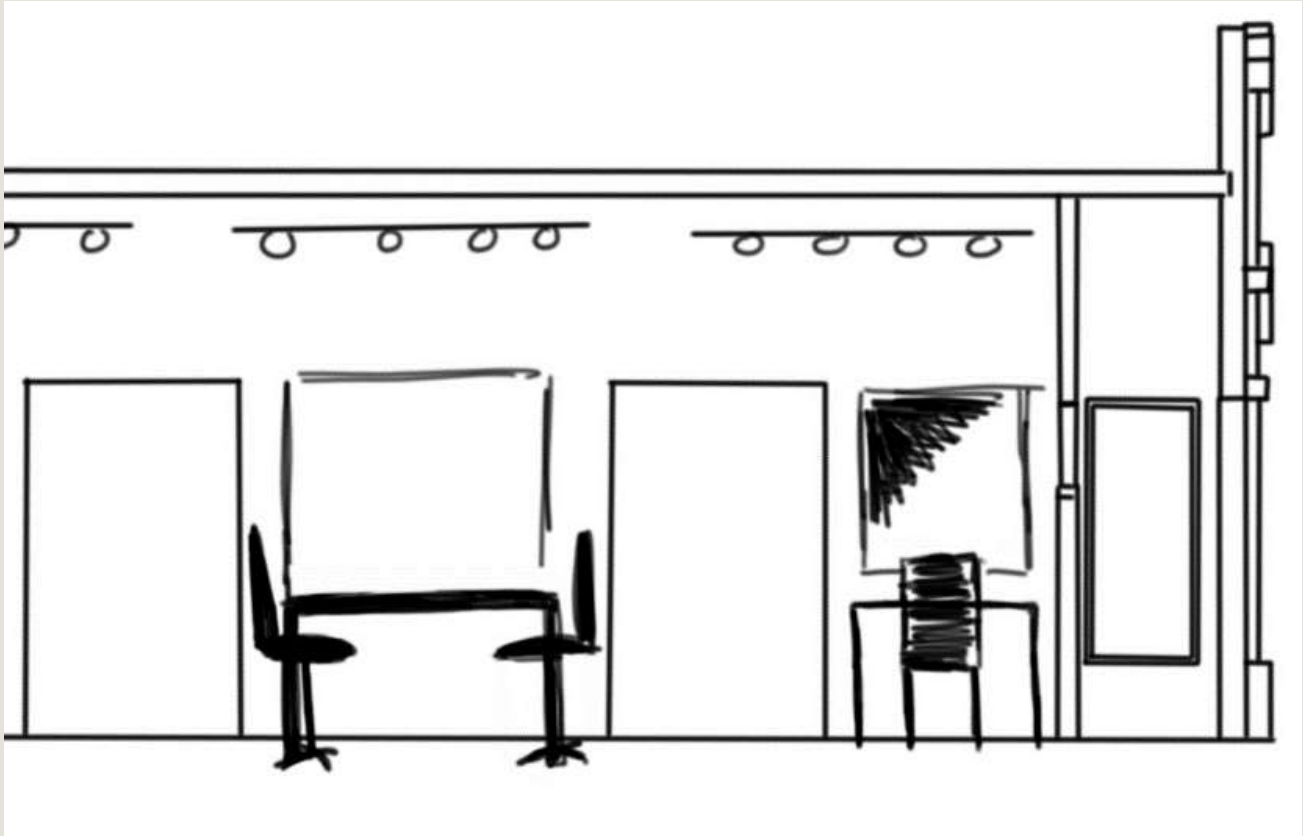
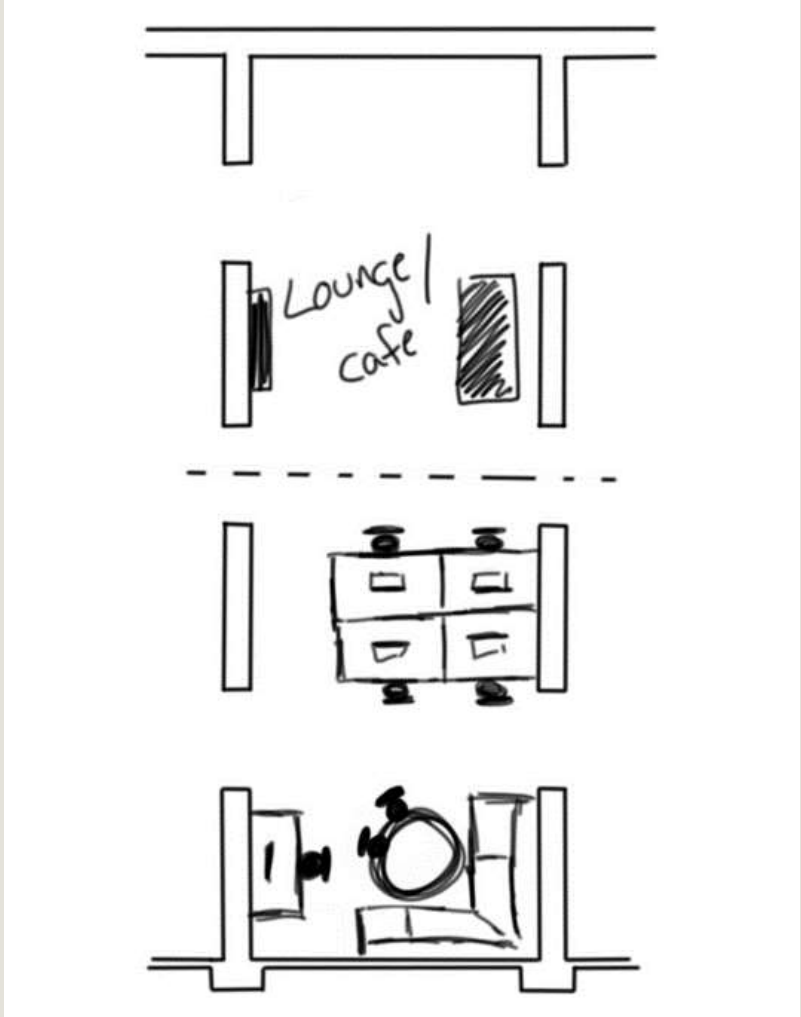

Assignment 11



Assignment 11

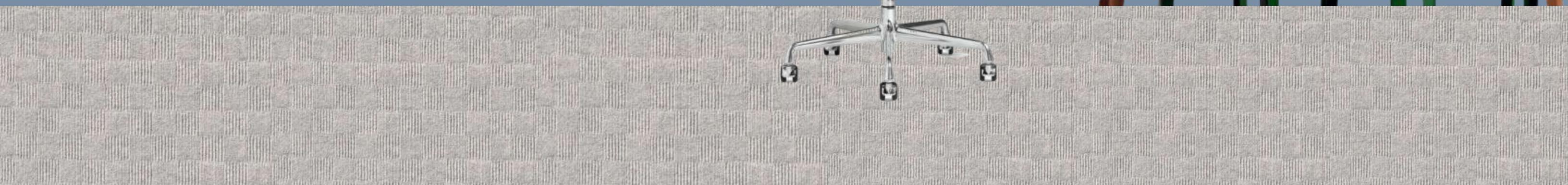
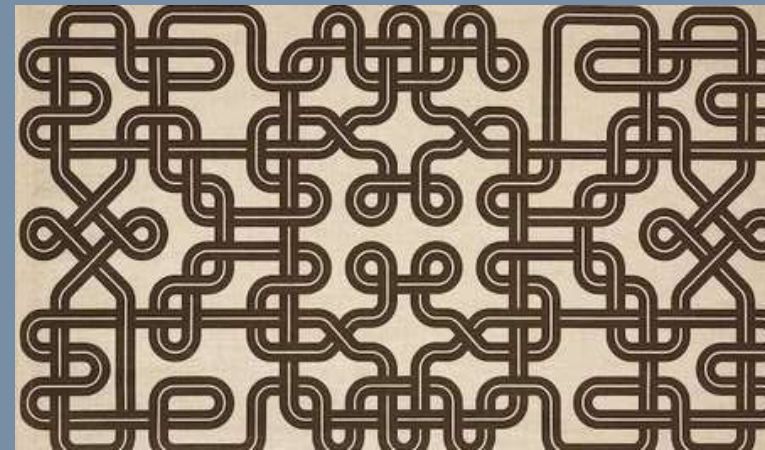
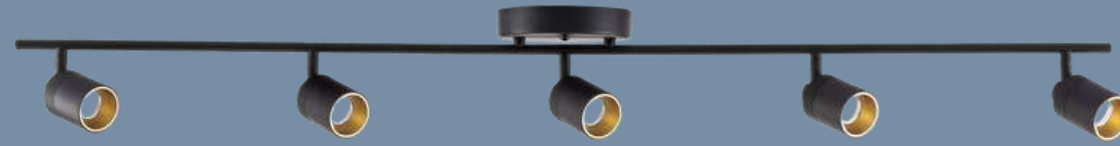

Assignment 12 - Lighting Model

