

Portfolio 2

IDSN 3102 Fall 2020

Hannah Rock

Circulation Plans

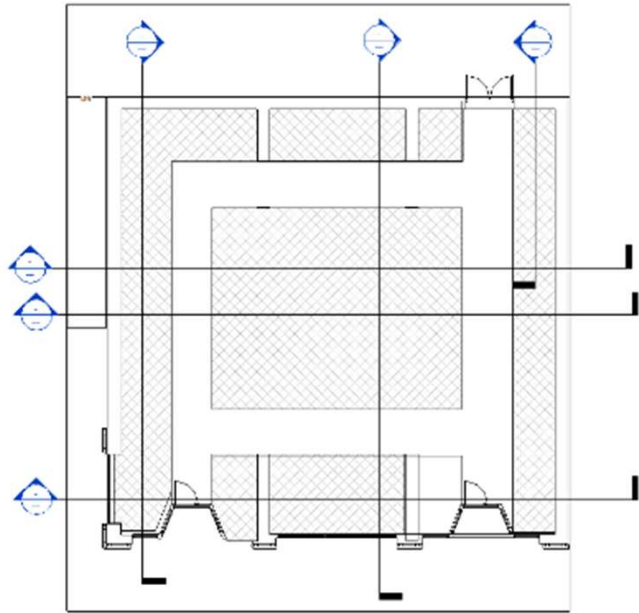
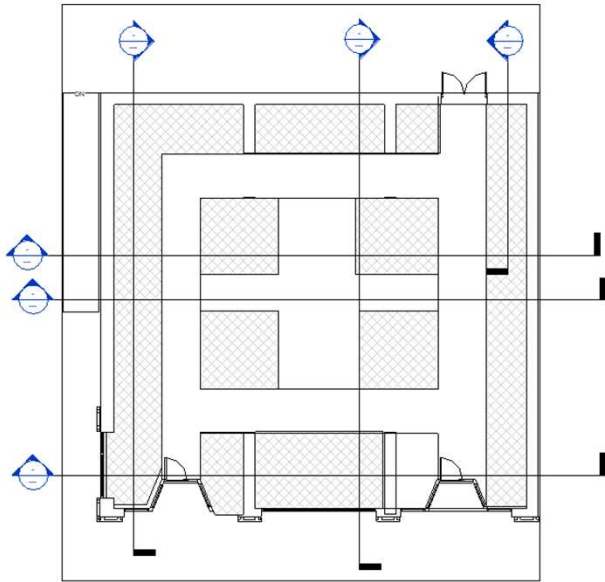

Ductwork Locations

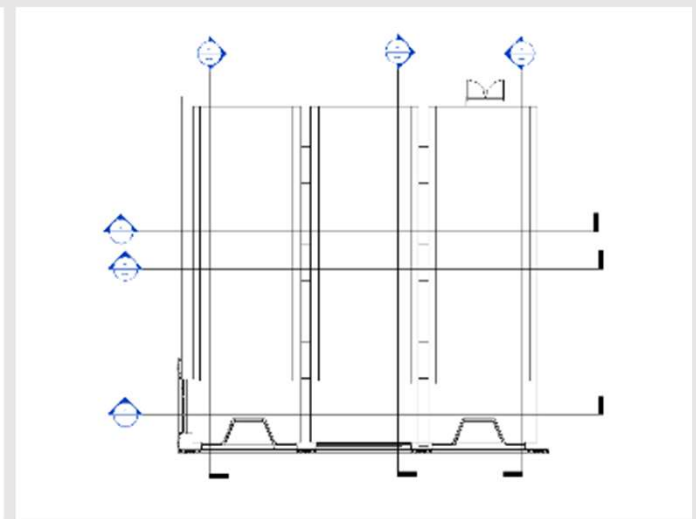
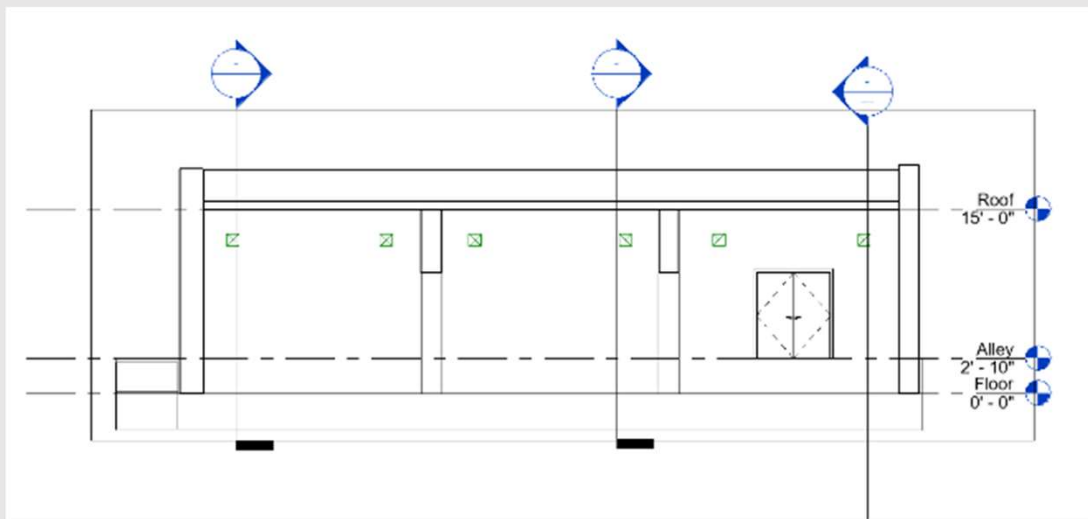

Space Plan Sketches



Space Plan Sketches



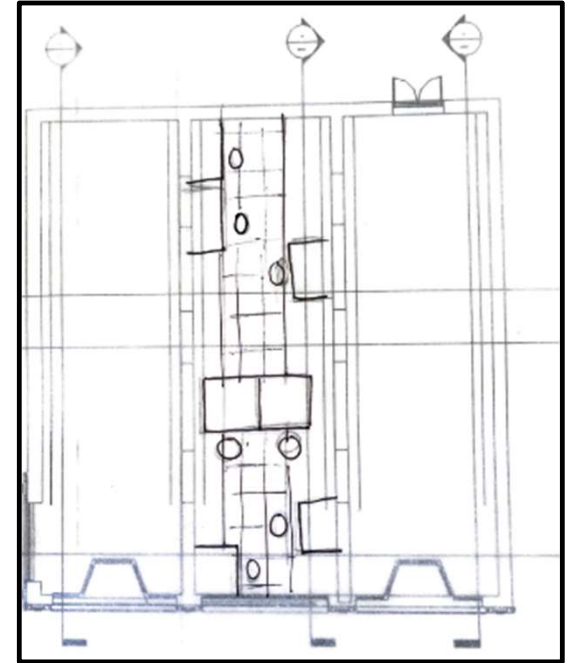
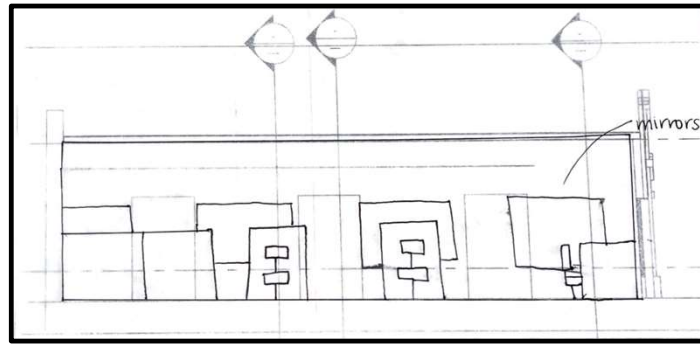
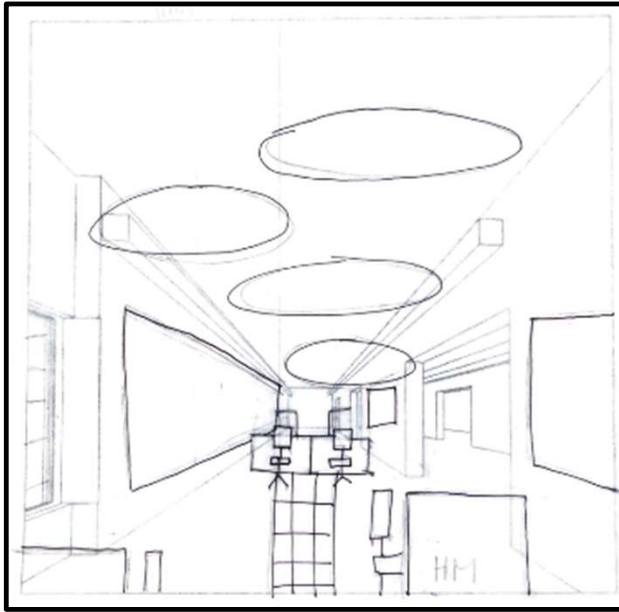

Problem Resolution Studies - Exploration

Problem Resolution Studies - Exploration

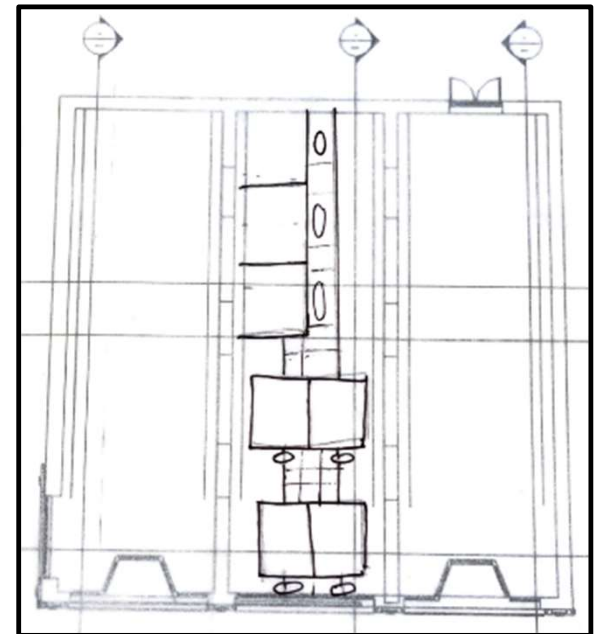
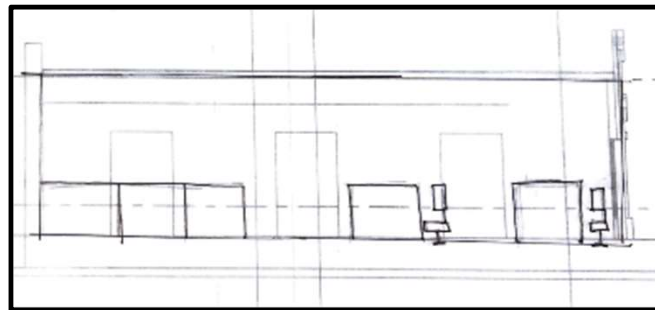
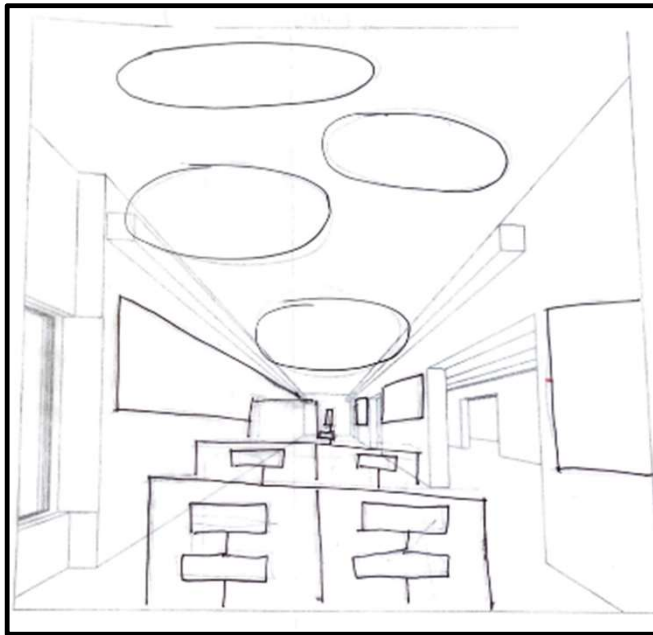

Problem Resolution Studies - Entry

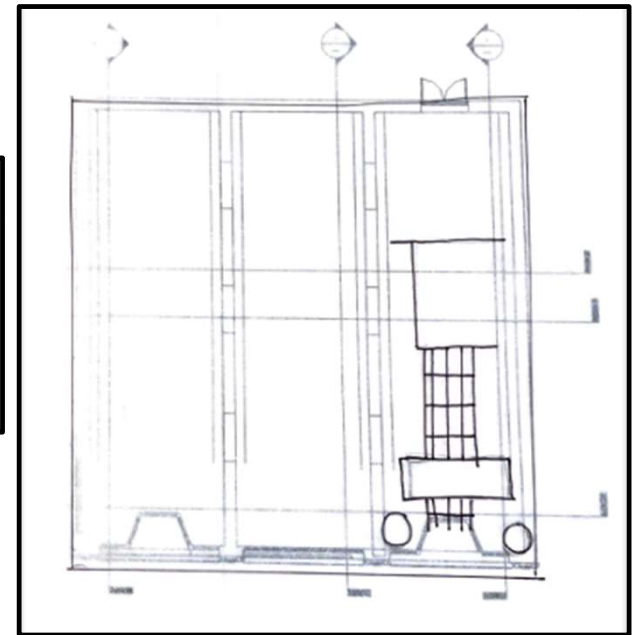
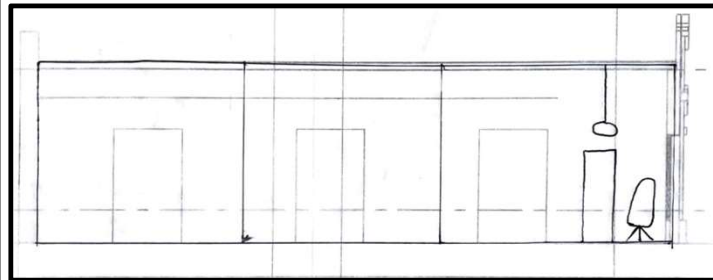
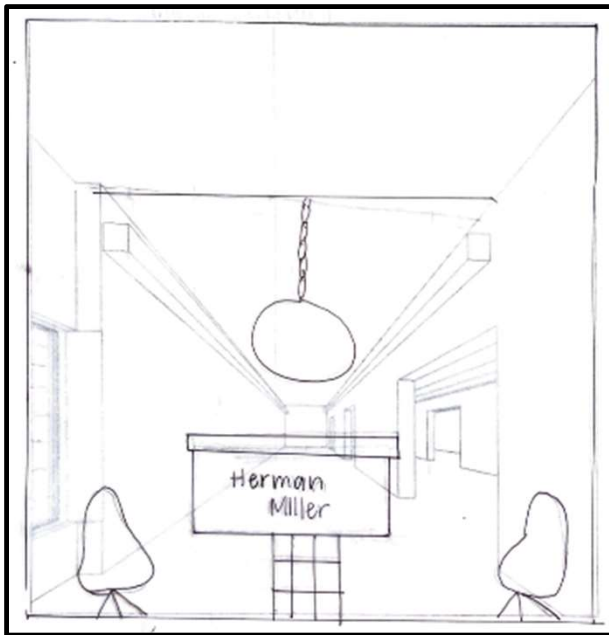

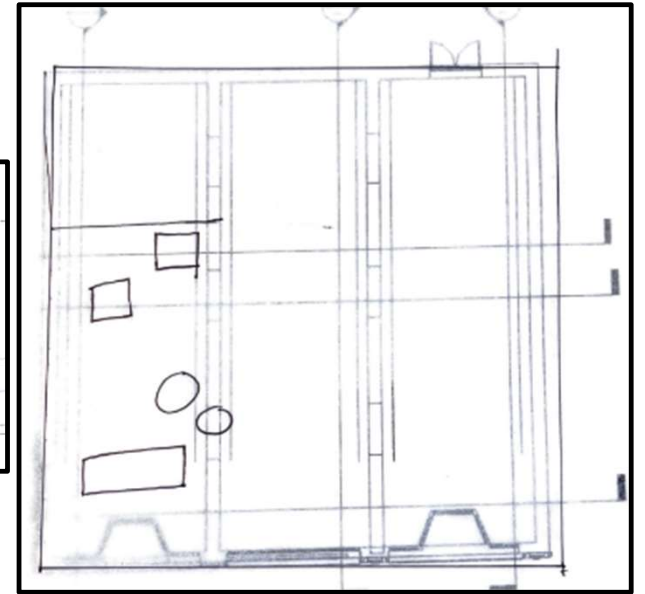
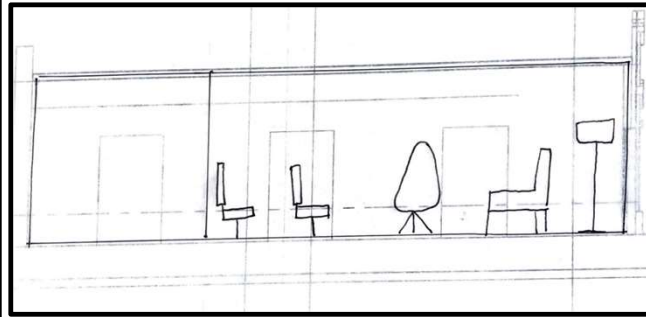
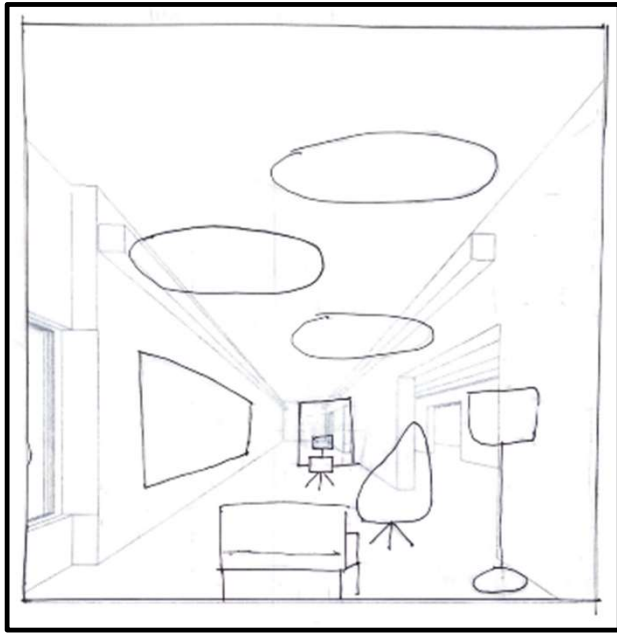

Problem Resolution Studies - Entry

Problem Resolution Studies – Ceiling/Daylight

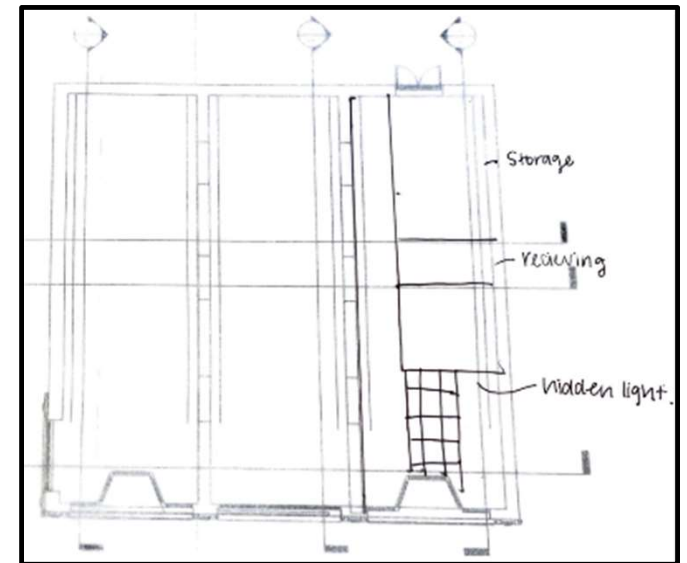
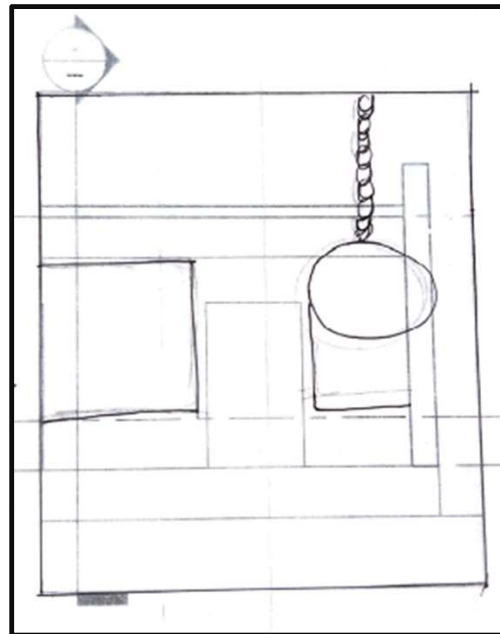
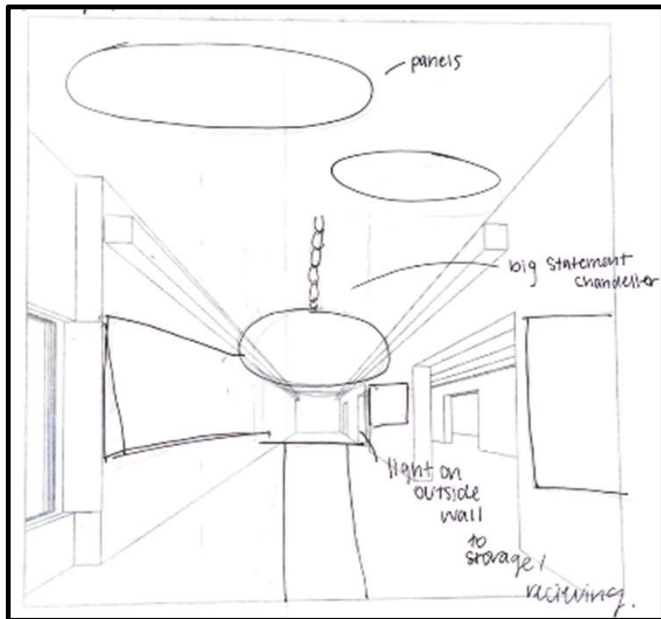

Problem Resolution Studies – Ceiling/Daylight

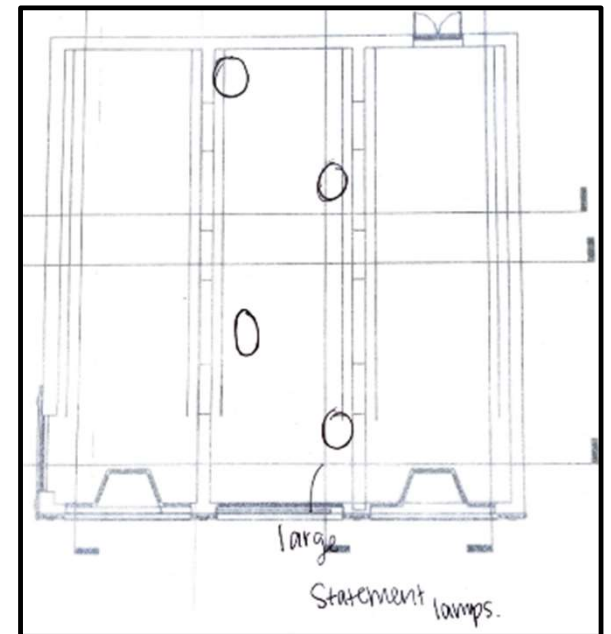
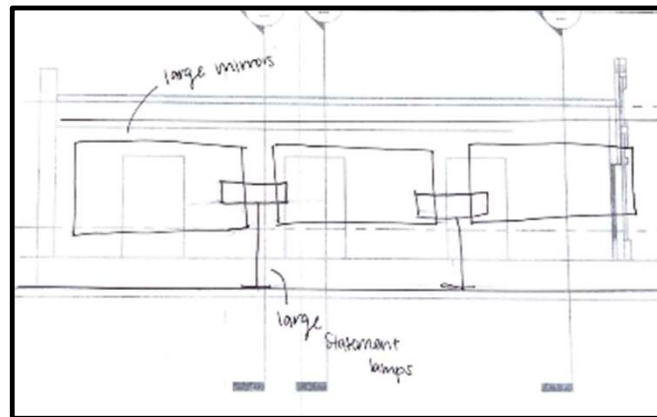
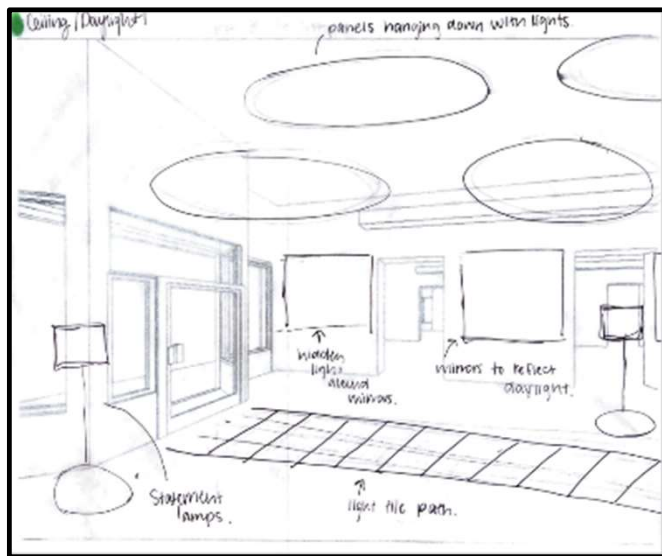

Problem Resolution Studies – Support Spaces

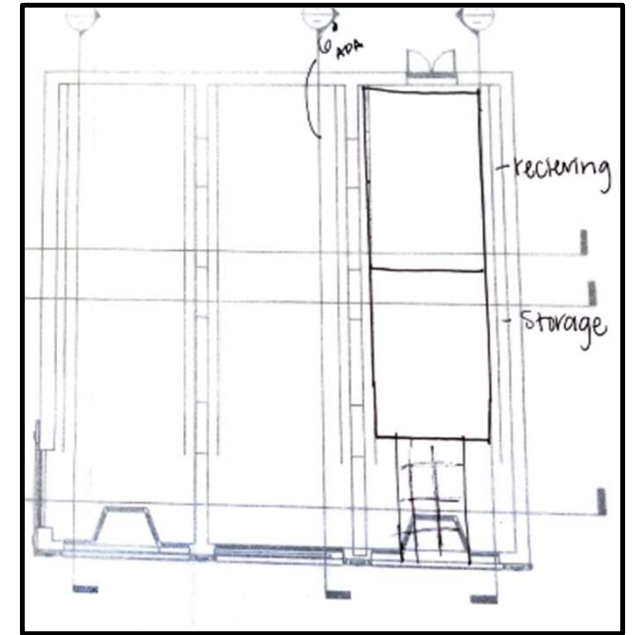
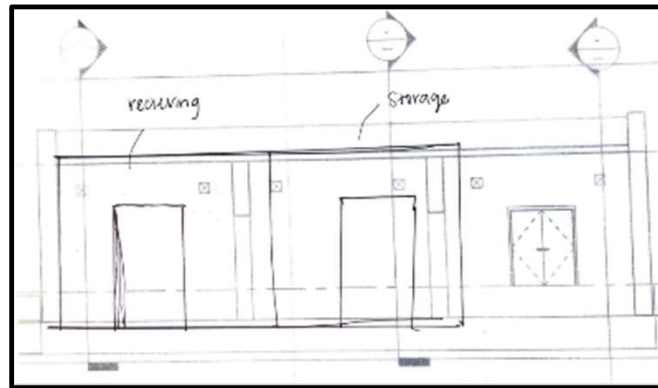
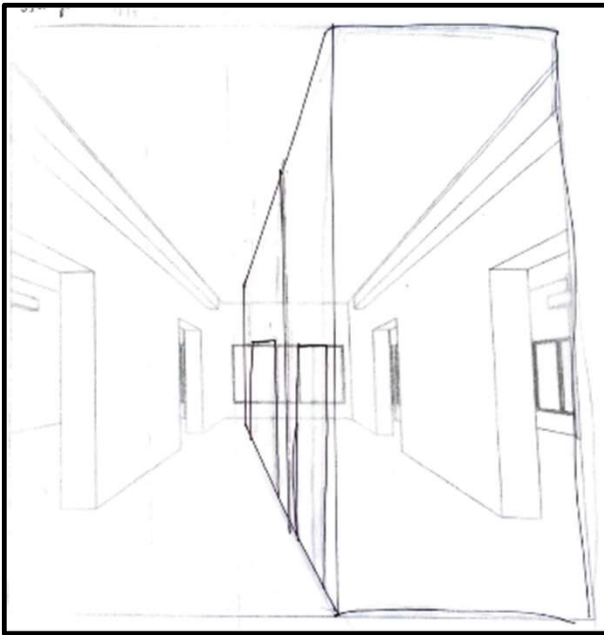

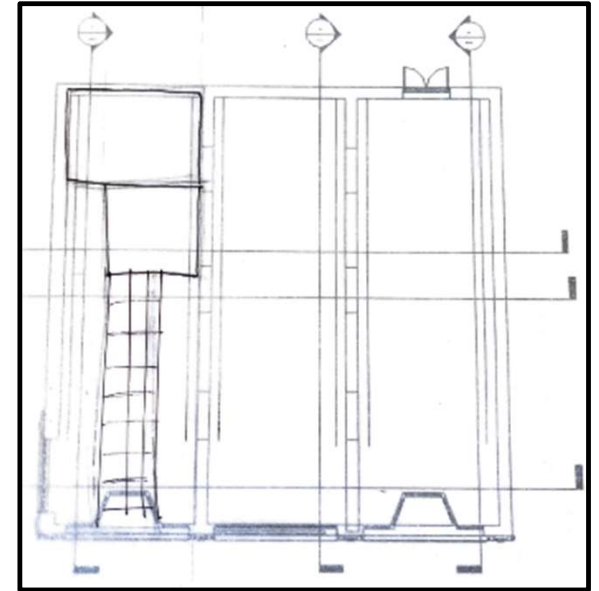
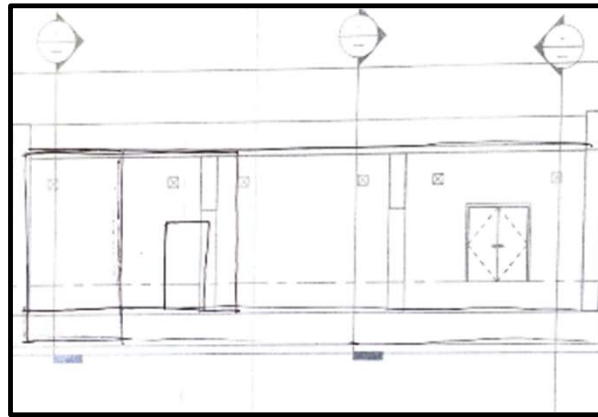
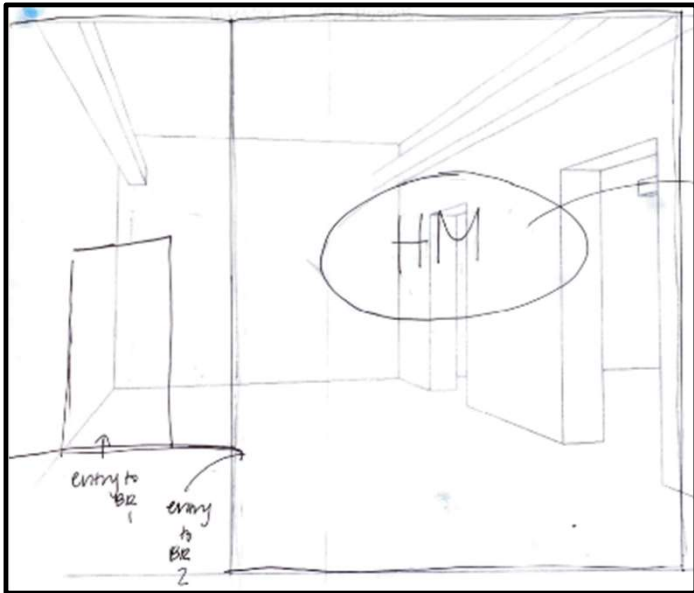

Problem Resolution Studies – Support Spaces

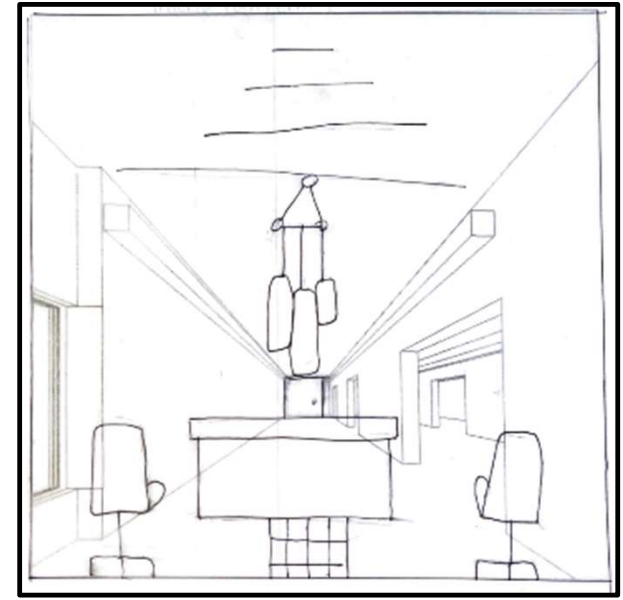
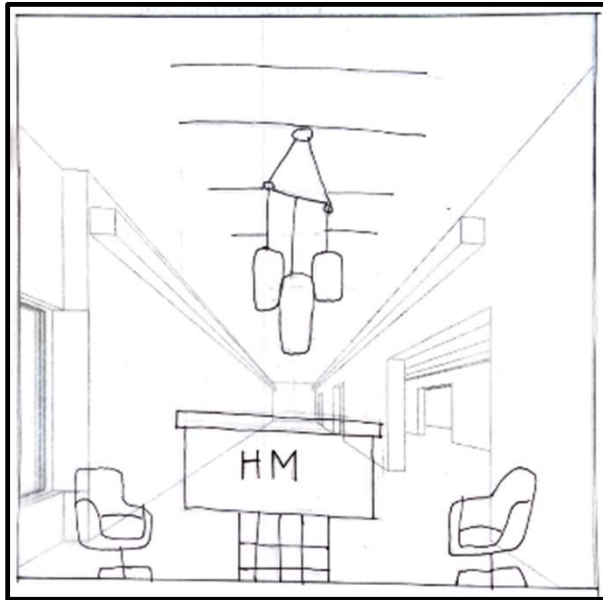

Design Synthesis Studies – Entry/Reception

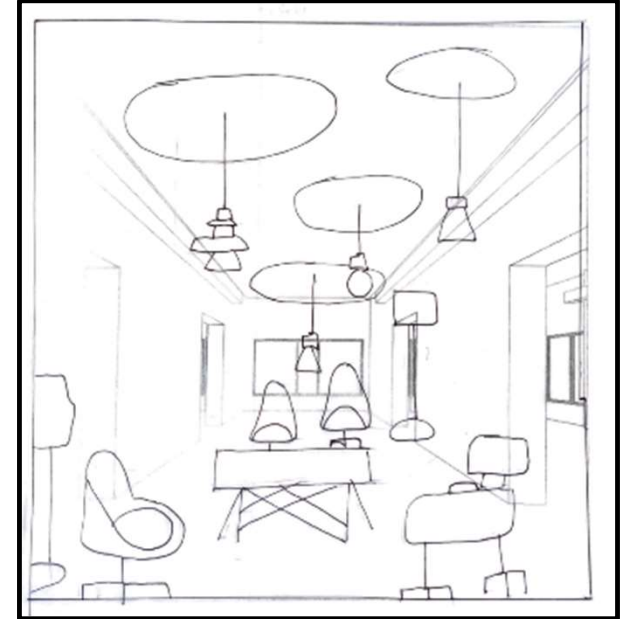
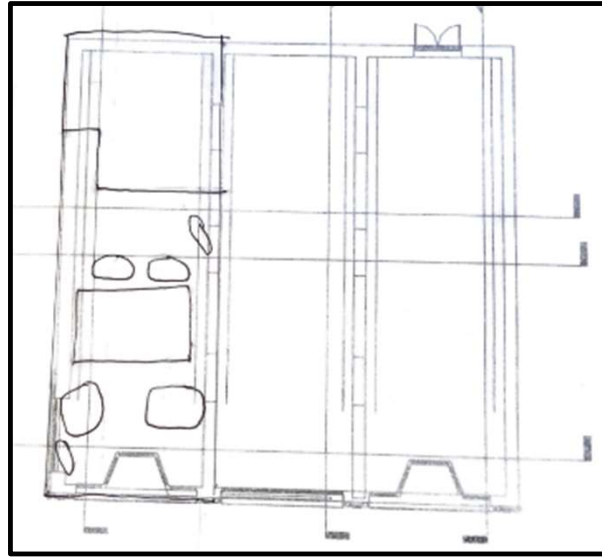
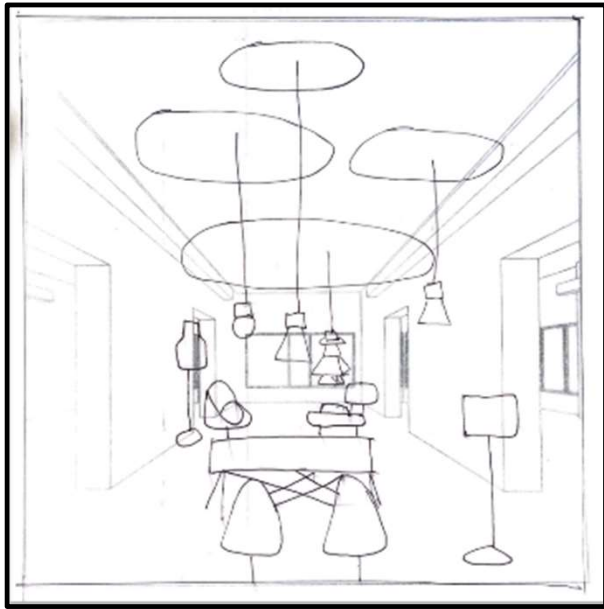

Design Synthesis Studies – Lounge

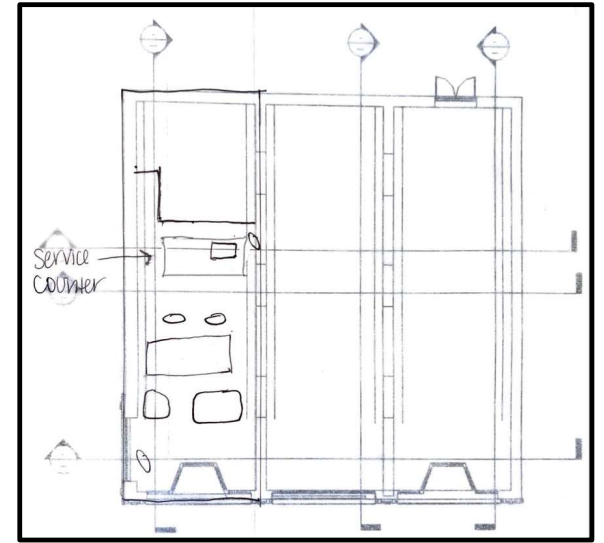
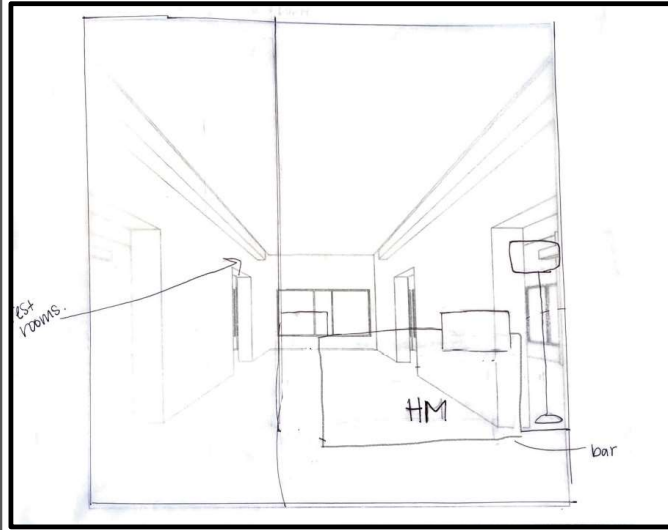
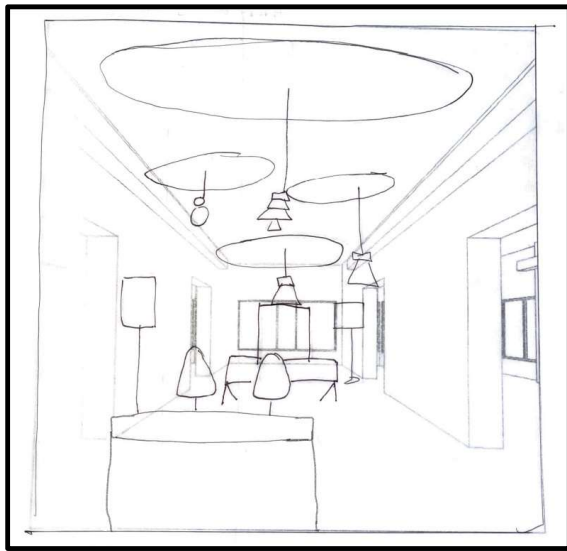

Design Synthesis Studies – Service Counter

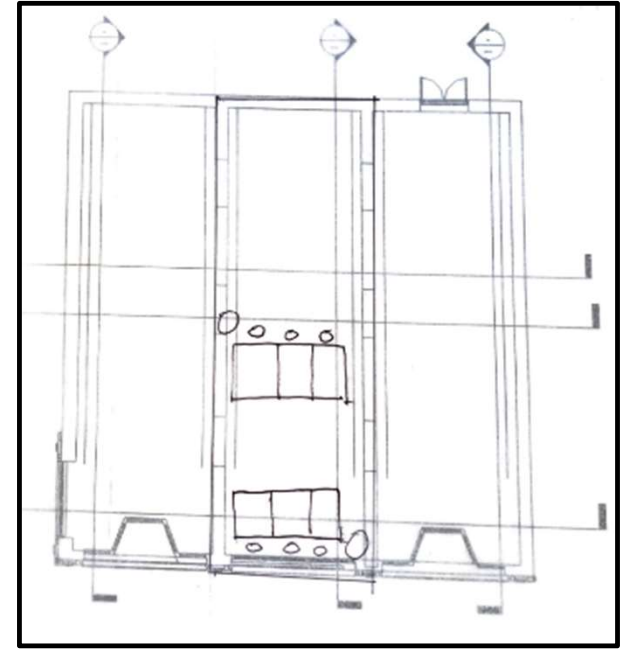
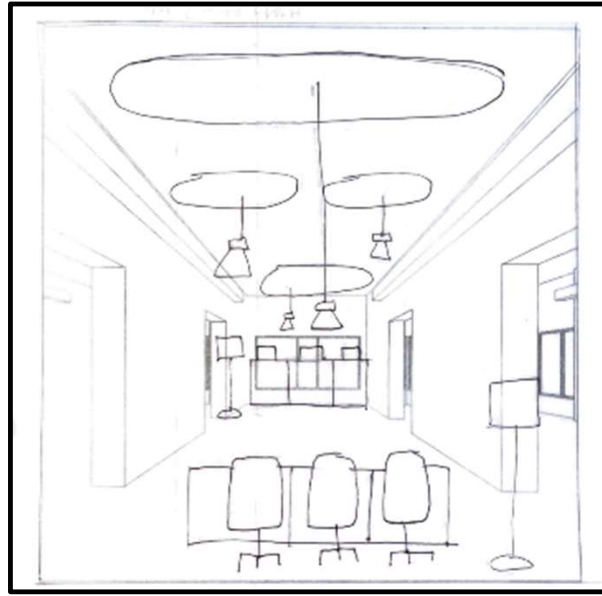

Design Synthesis Studies – Work Area

Furniture and Finish Pallets

Community Space / Lounge

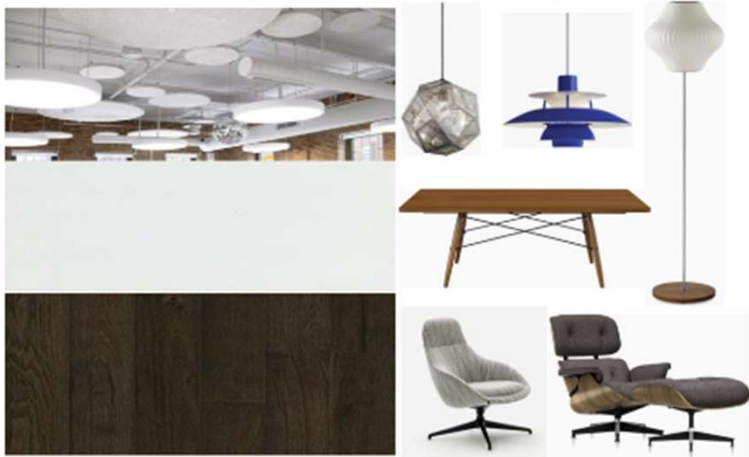

Reception / Entry

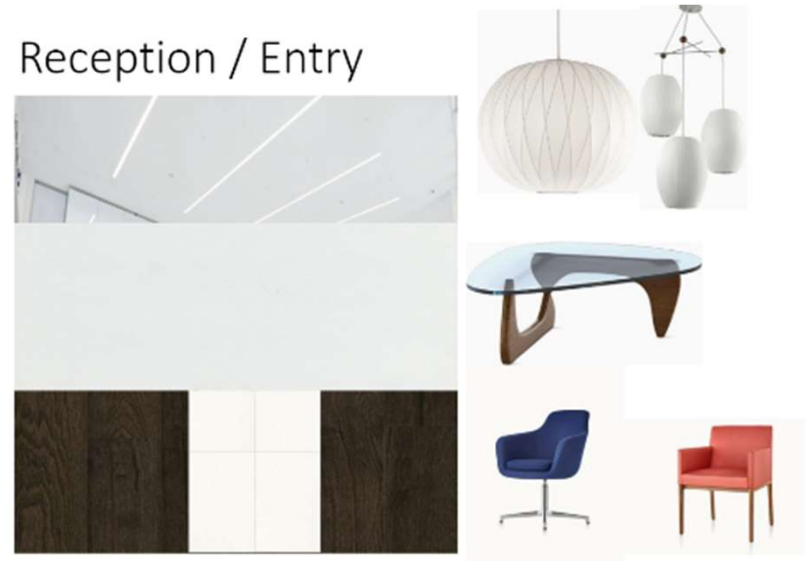

Furniture and Finish Pallets

Service Counter



Workspace / Area

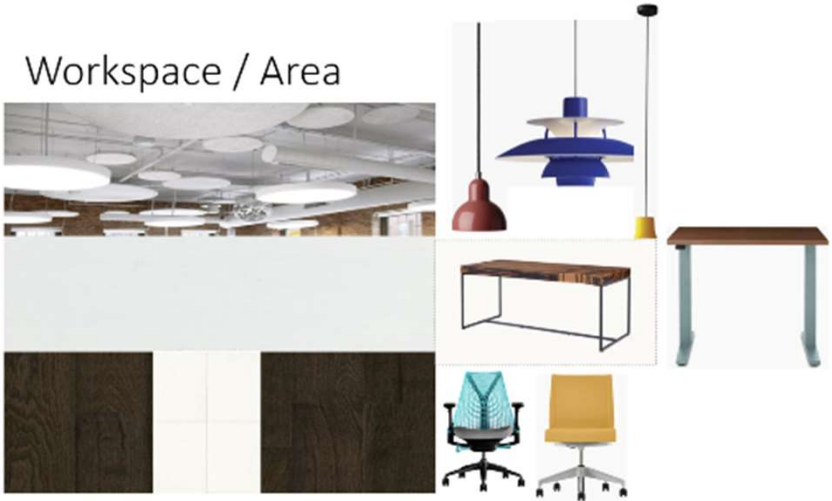



Lighting Model - Reception