



# HERMAN MILLER SHOWROOM PORTFOLIO 2

IDSN 3102 Fall Semester  
Jessica Stark



# CIRCULATION PLANS

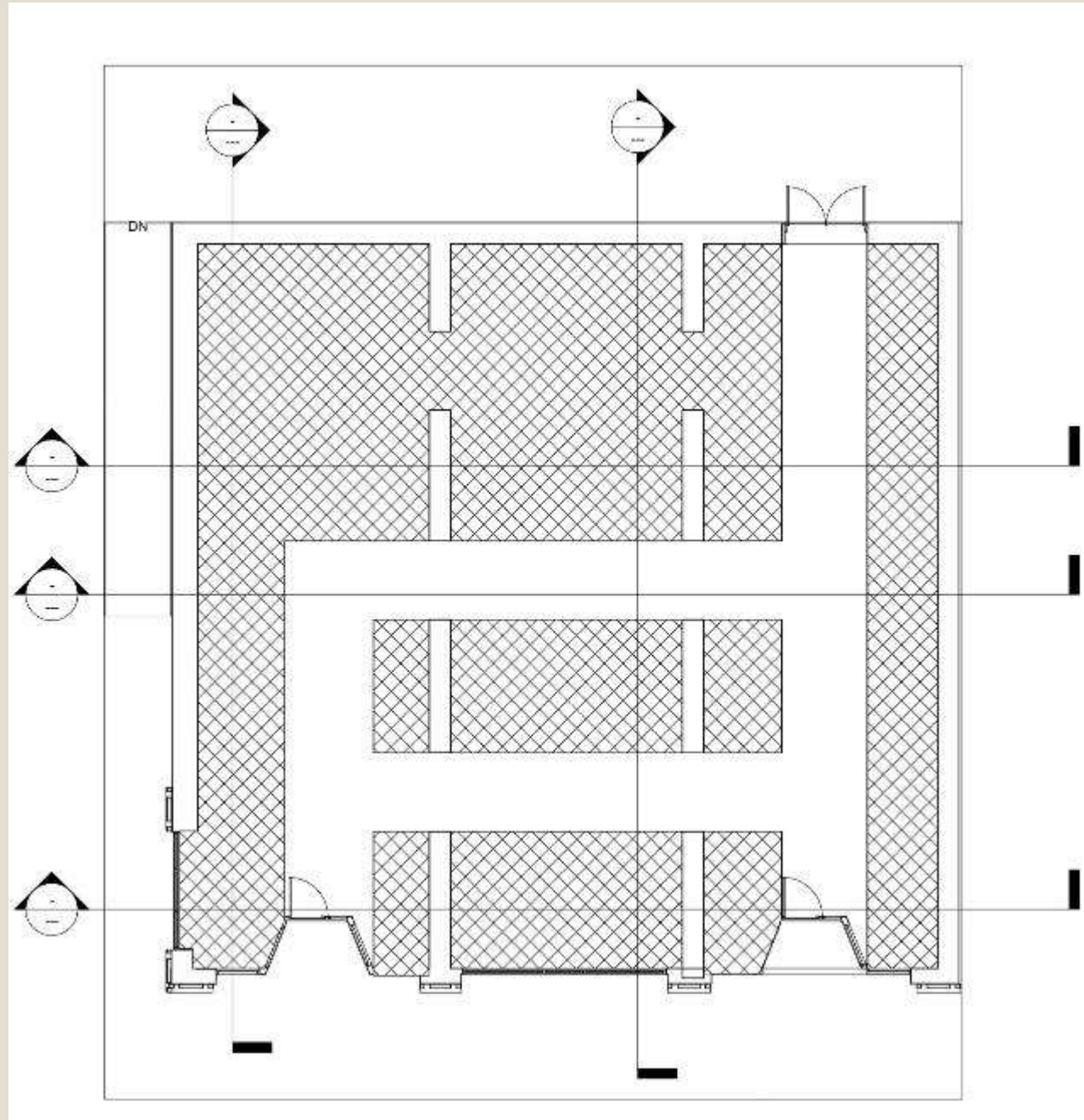

Plan 1

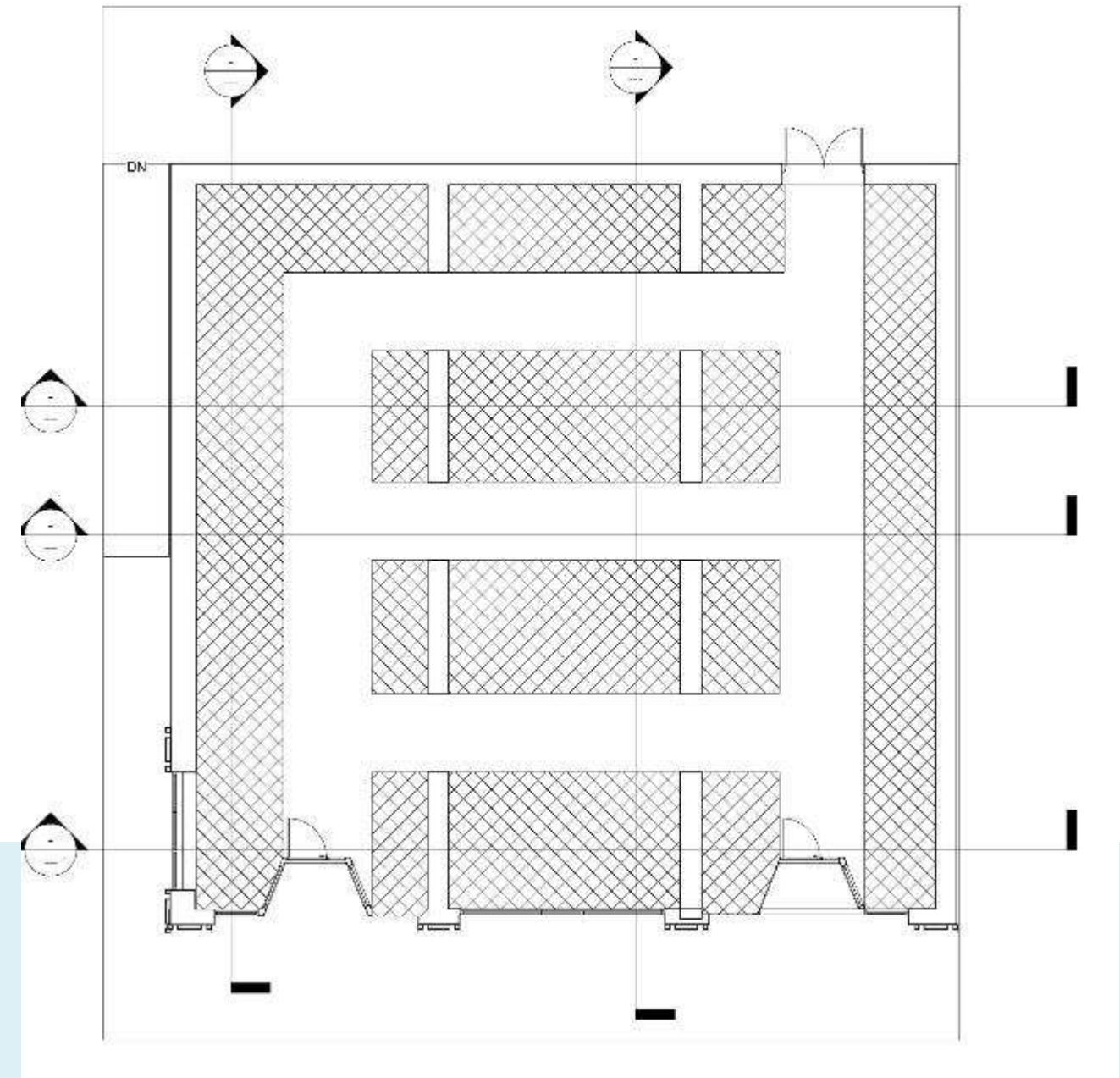

Plan 2

# DUCTWORK PLAN AND SECTION

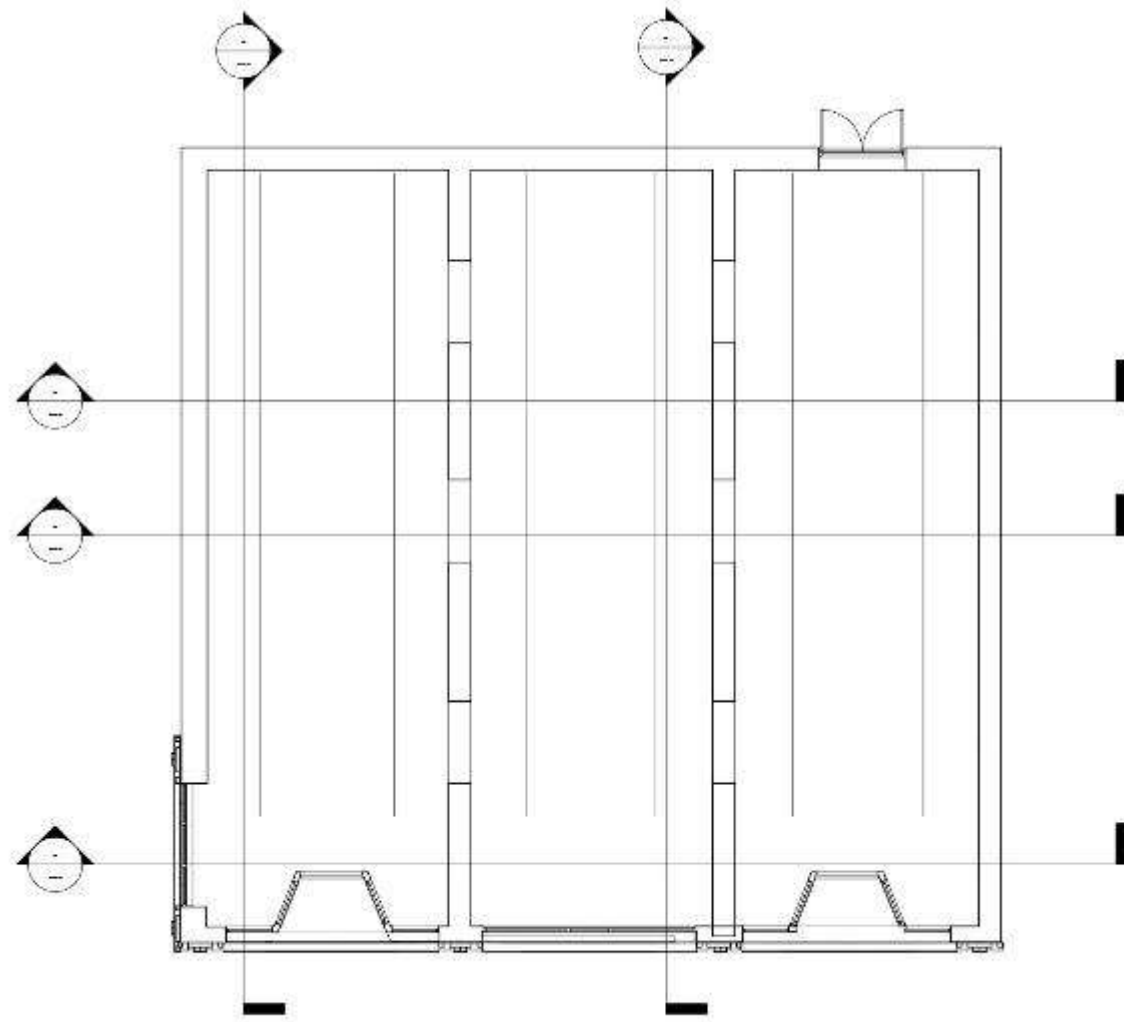

Plan View

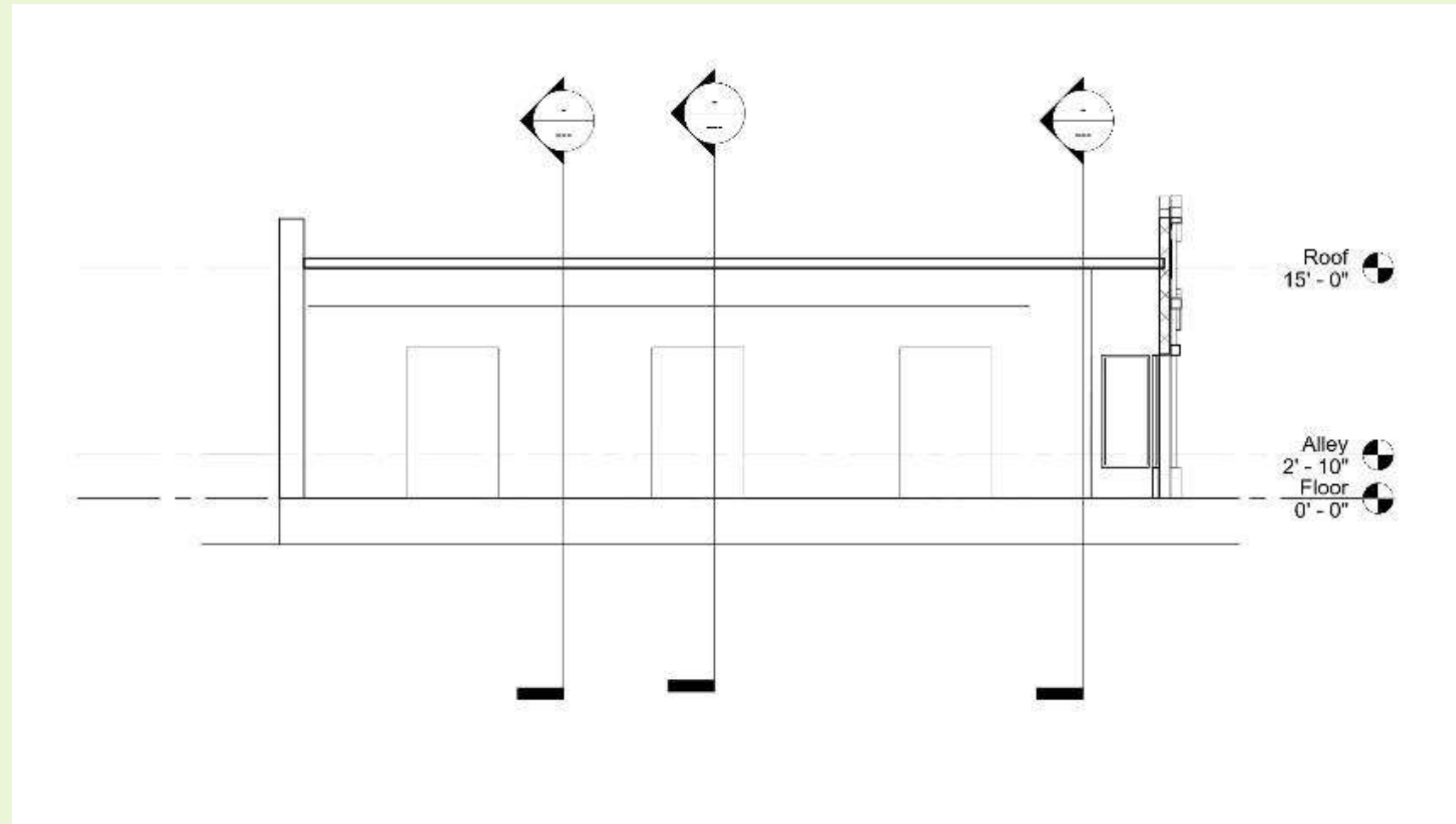

Section View

# SPACE PLAN SKETCHES 1,2

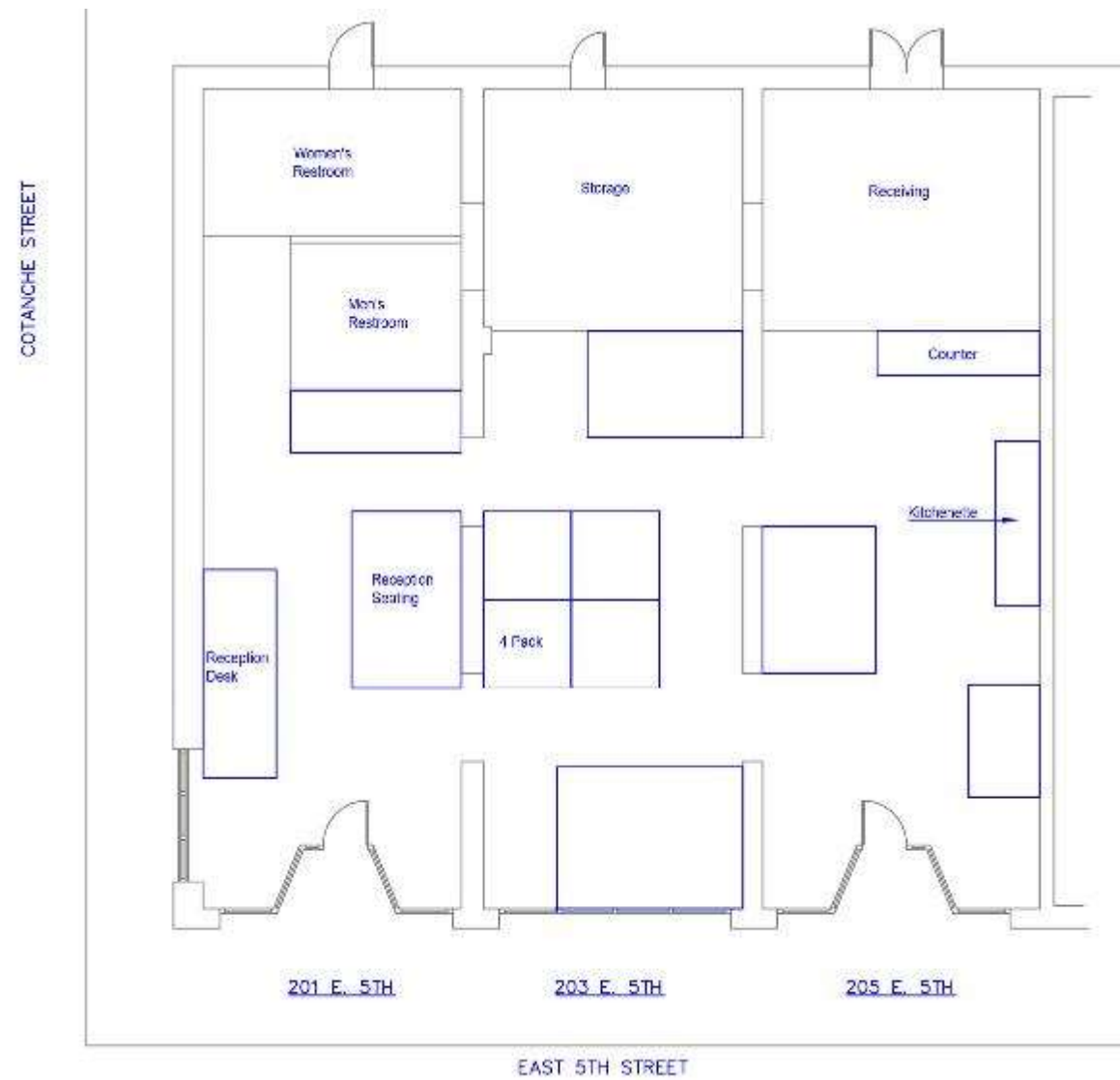

Plan 1

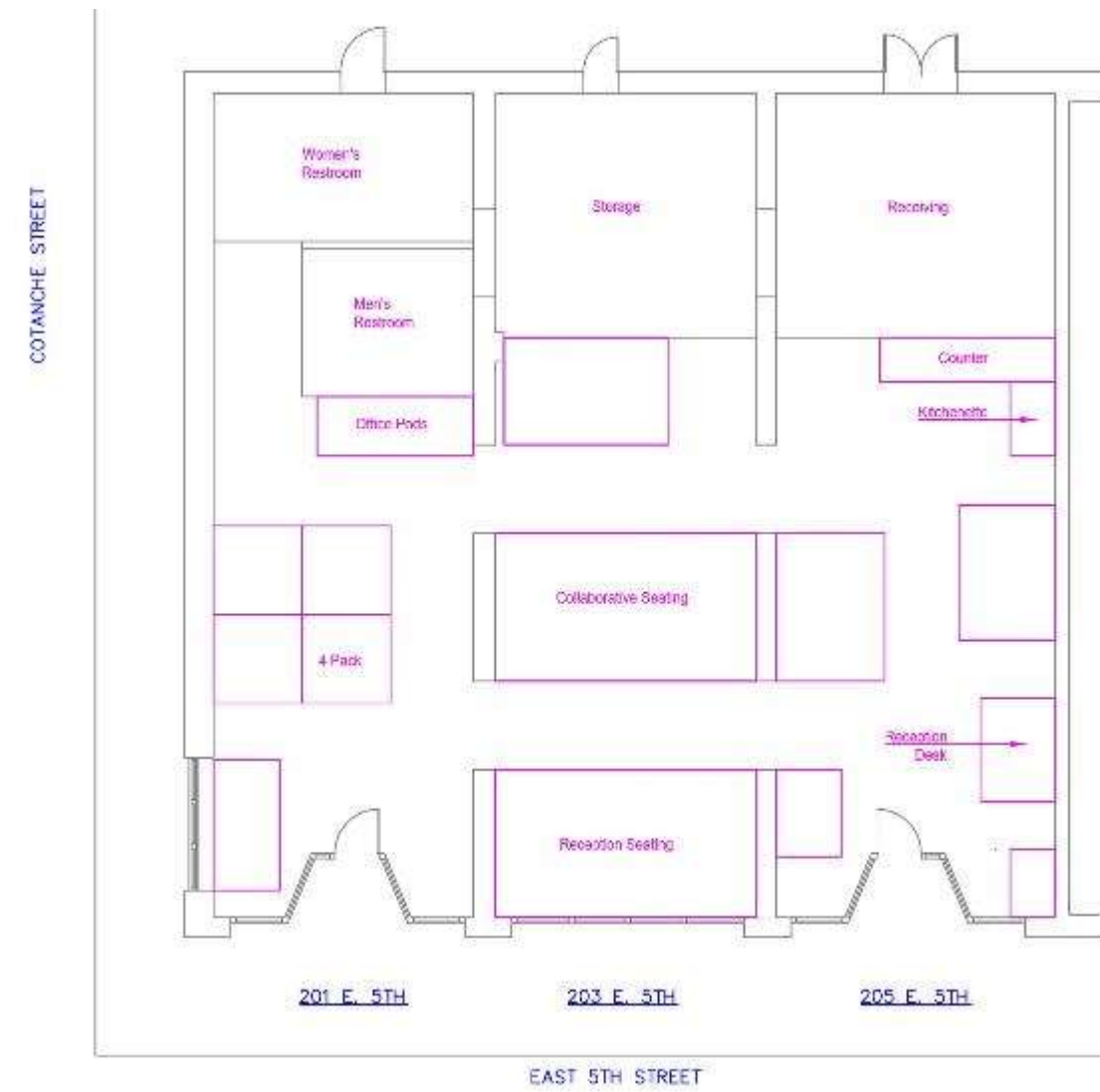

Plan 2

# SPACE PLAN SKETCHES 3-5

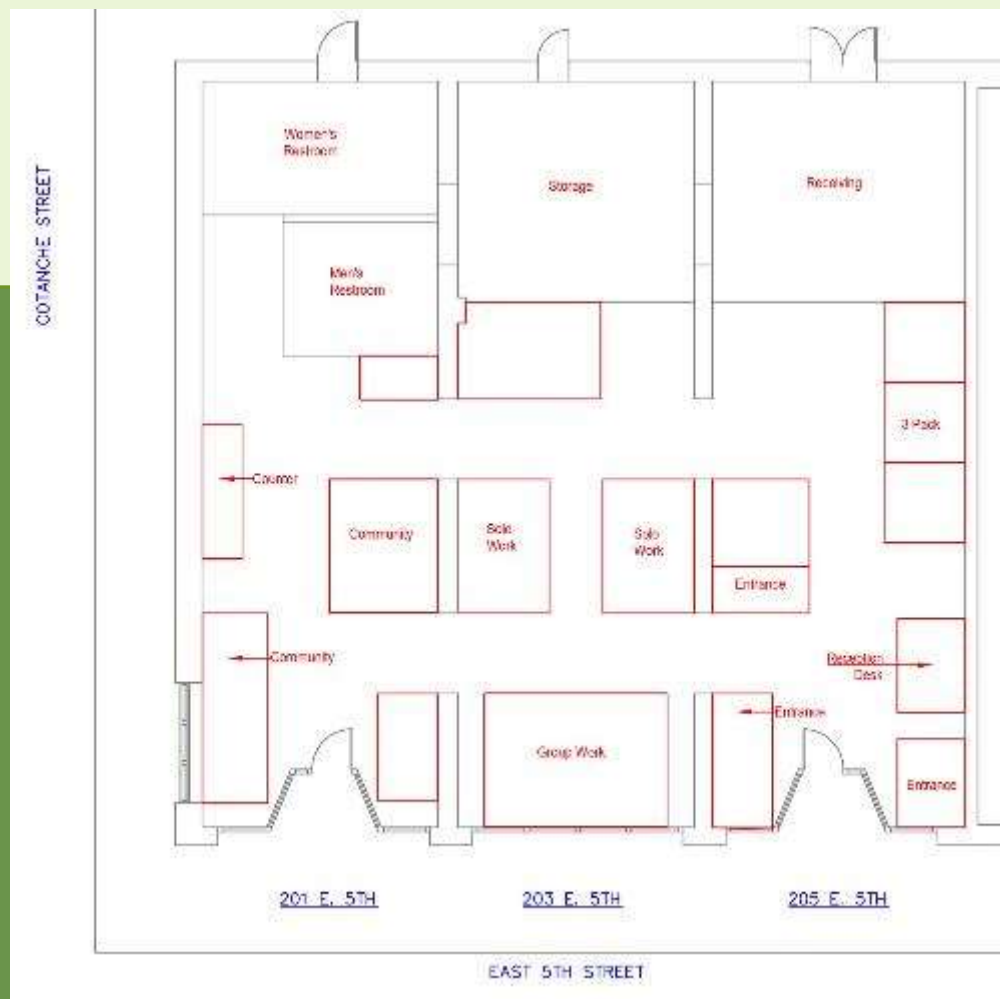

Plan 3



Plan 4

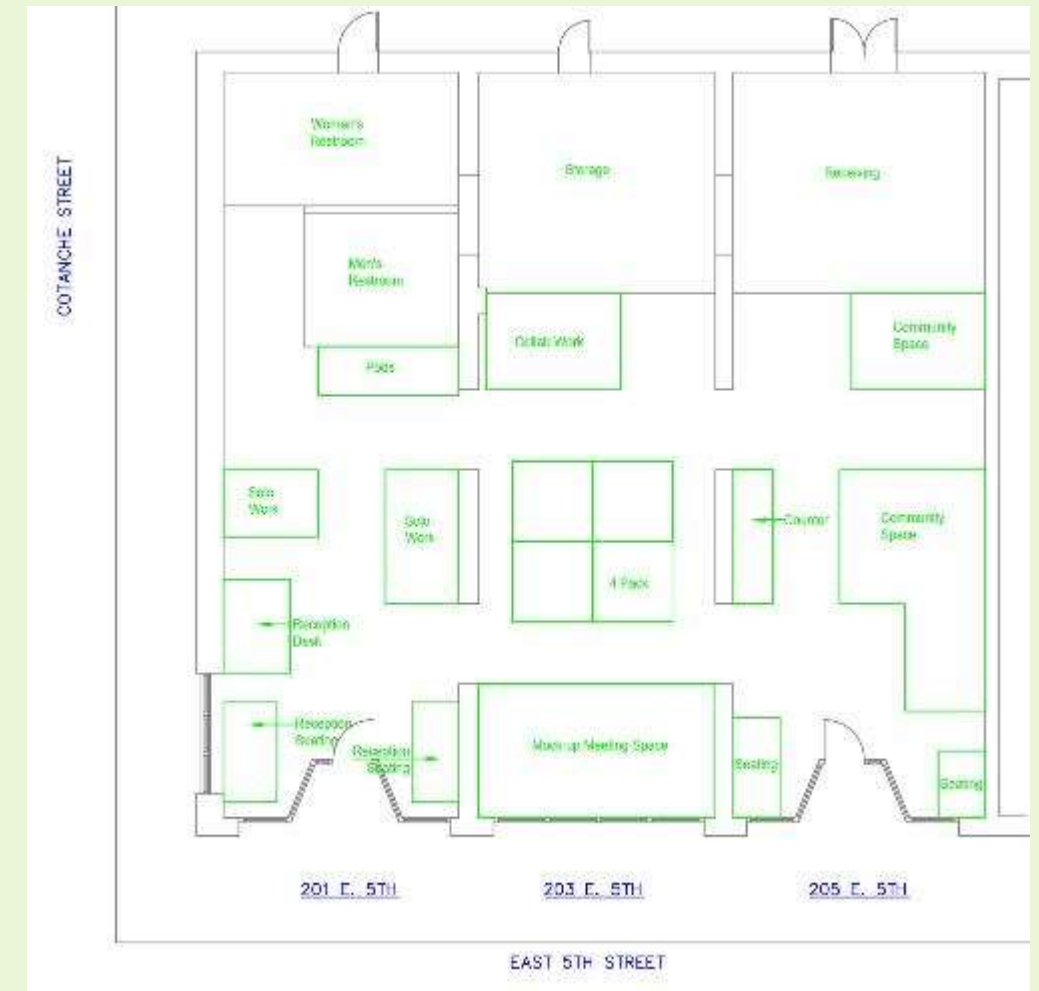

Plan 5



# PROBLEM RESOLUTION SKETCHES

## - ENTRY OPTION 1

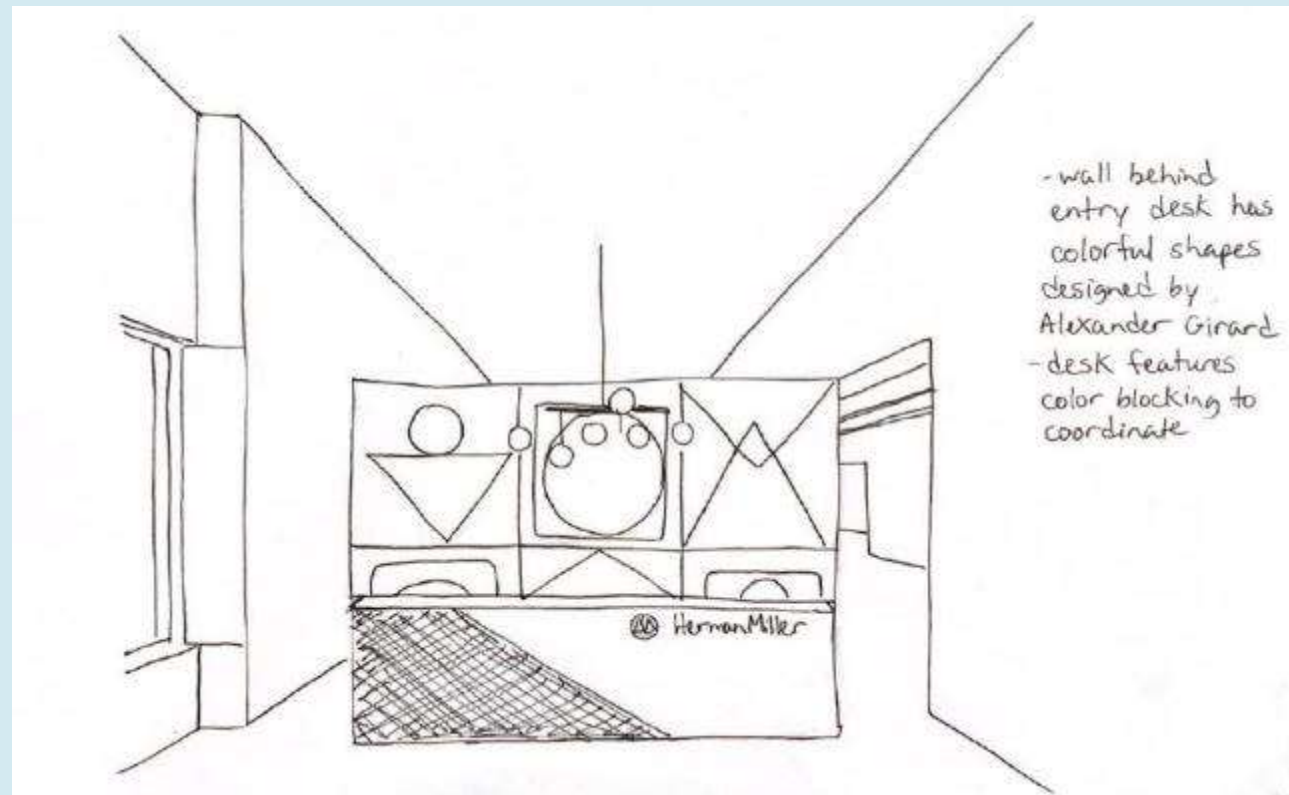

Perspective View

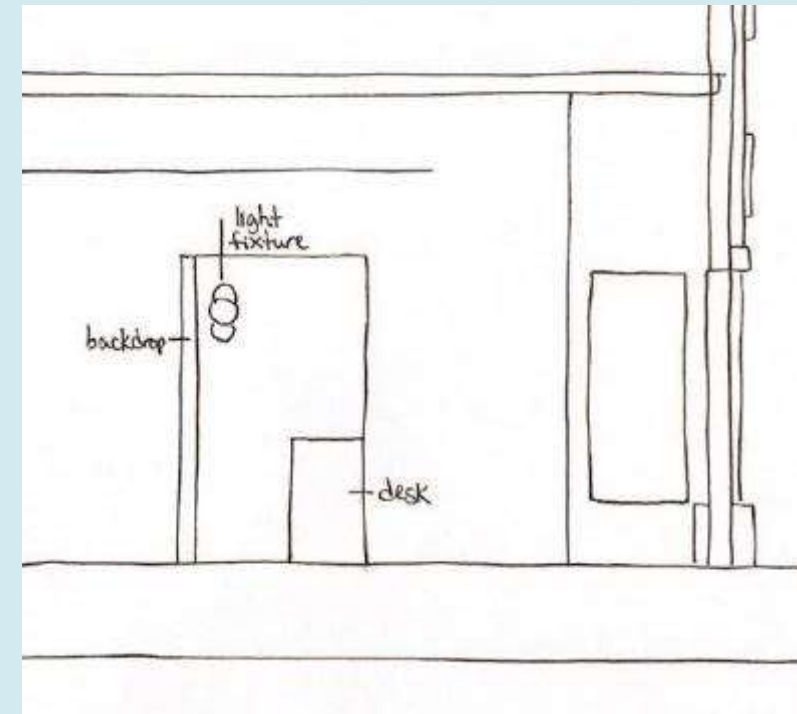

Section View

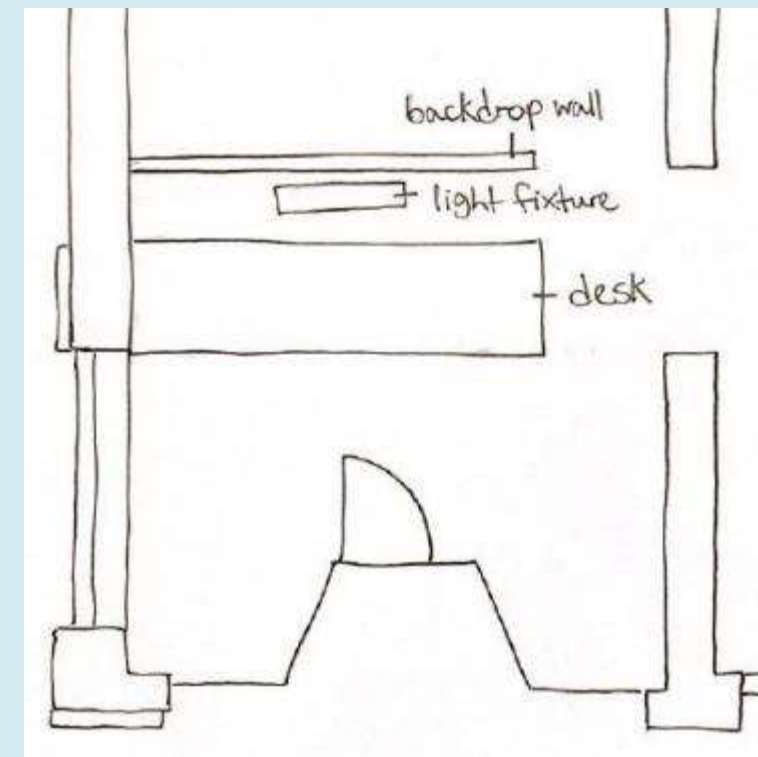

Plan View

# PROBLEM RESOLUTION SKETCHES

## - ENTRY OPTION 2

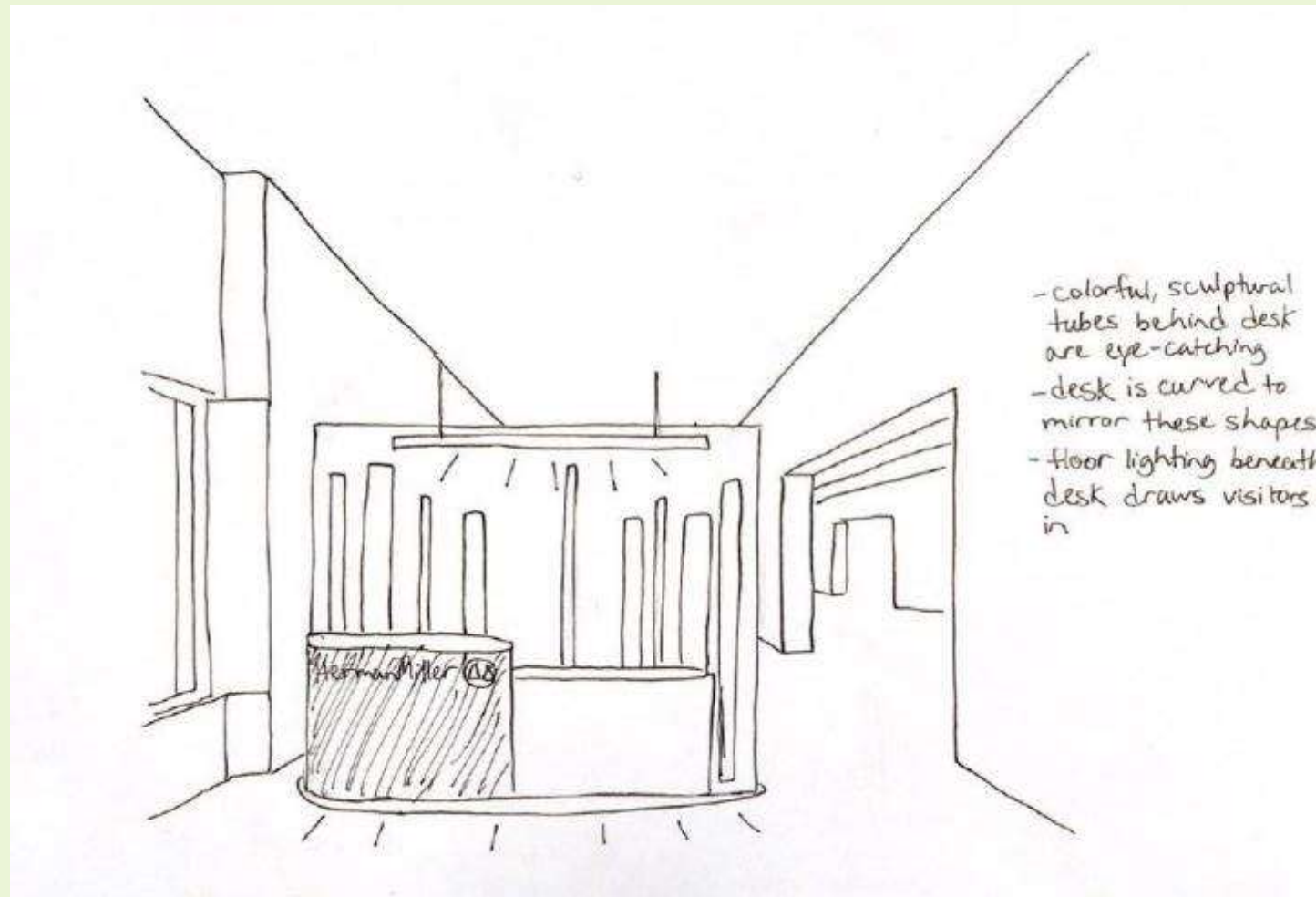

Perspective View

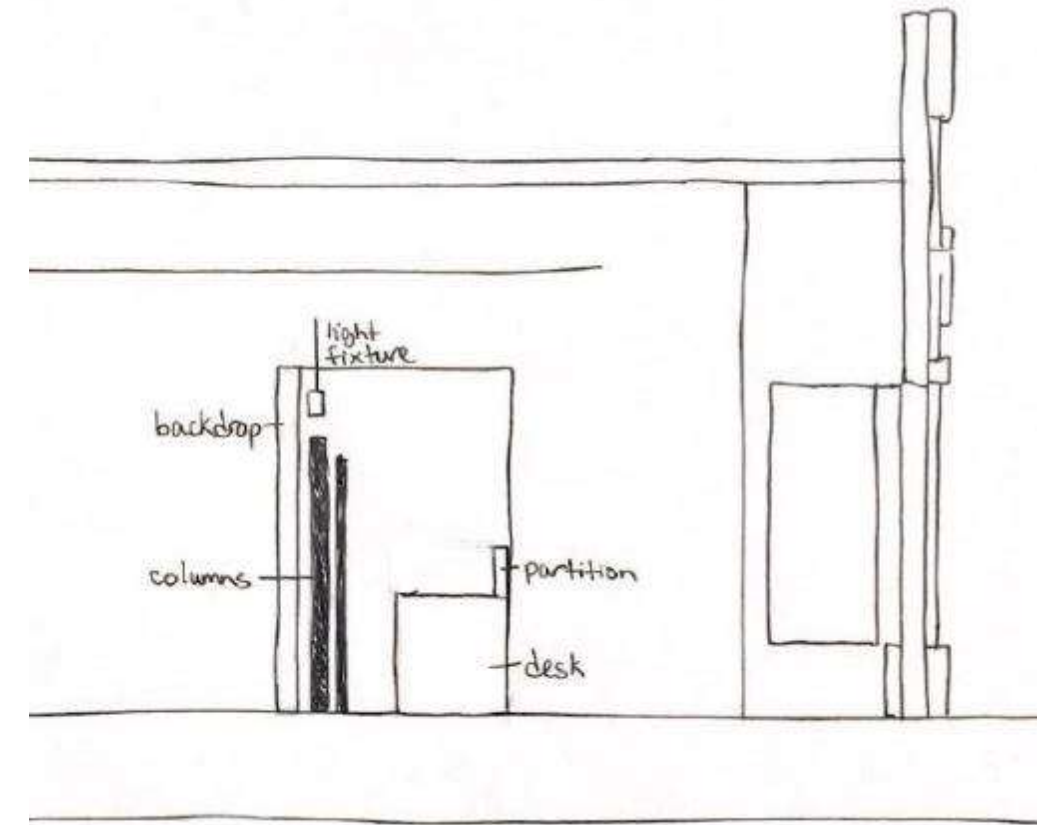

Section View

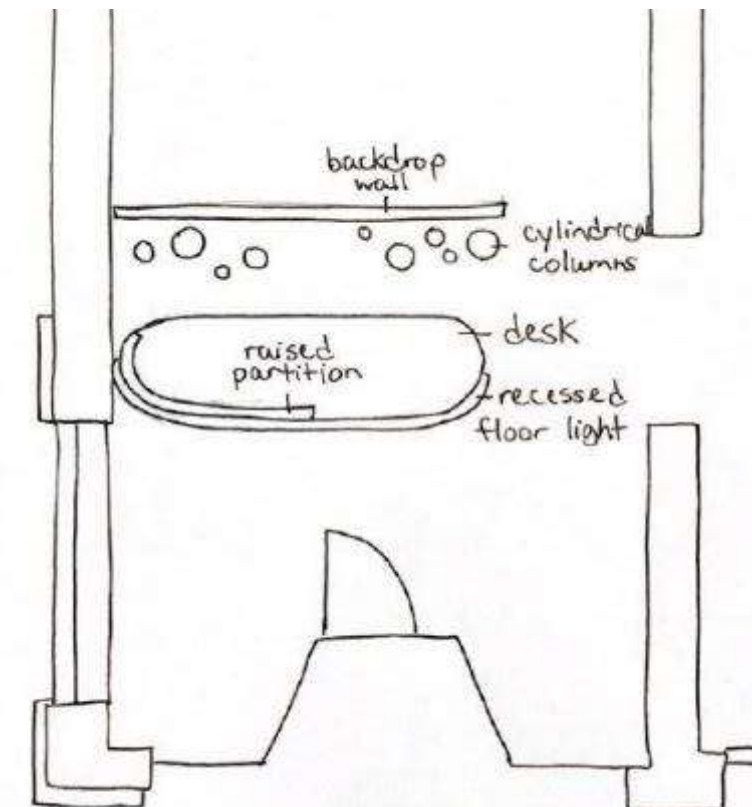

Plan View

# PROBLEM RESOLUTION SKETCHES

## - WAYFINDING OPTION 1

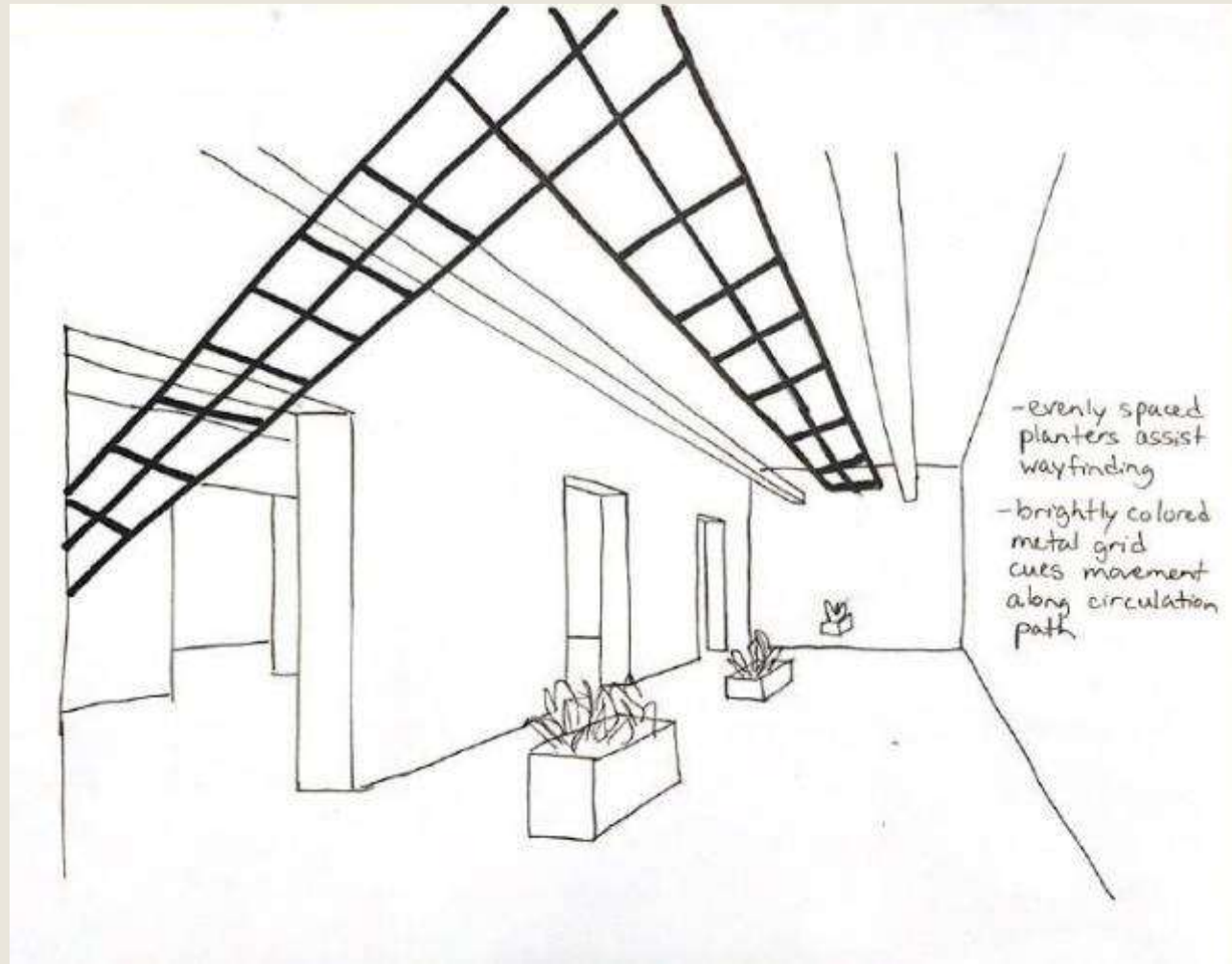

Perspective View

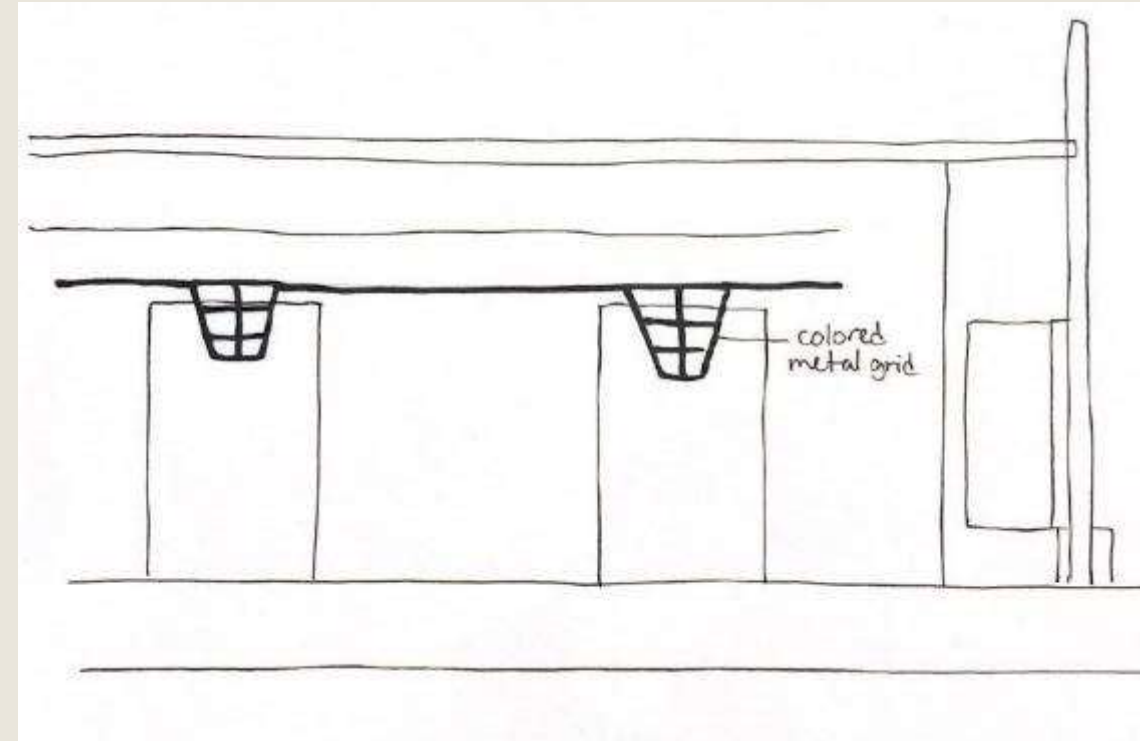

Section View

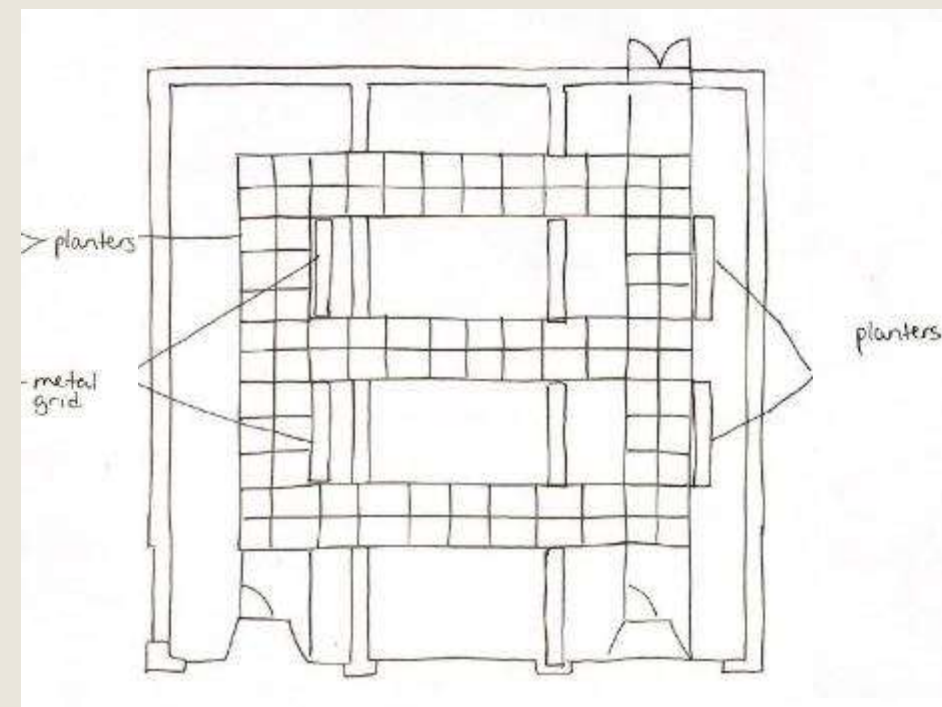

Plan View



# PROBLEM RESOLUTION SKETCHES

## - WAYFINDING OPTION 2

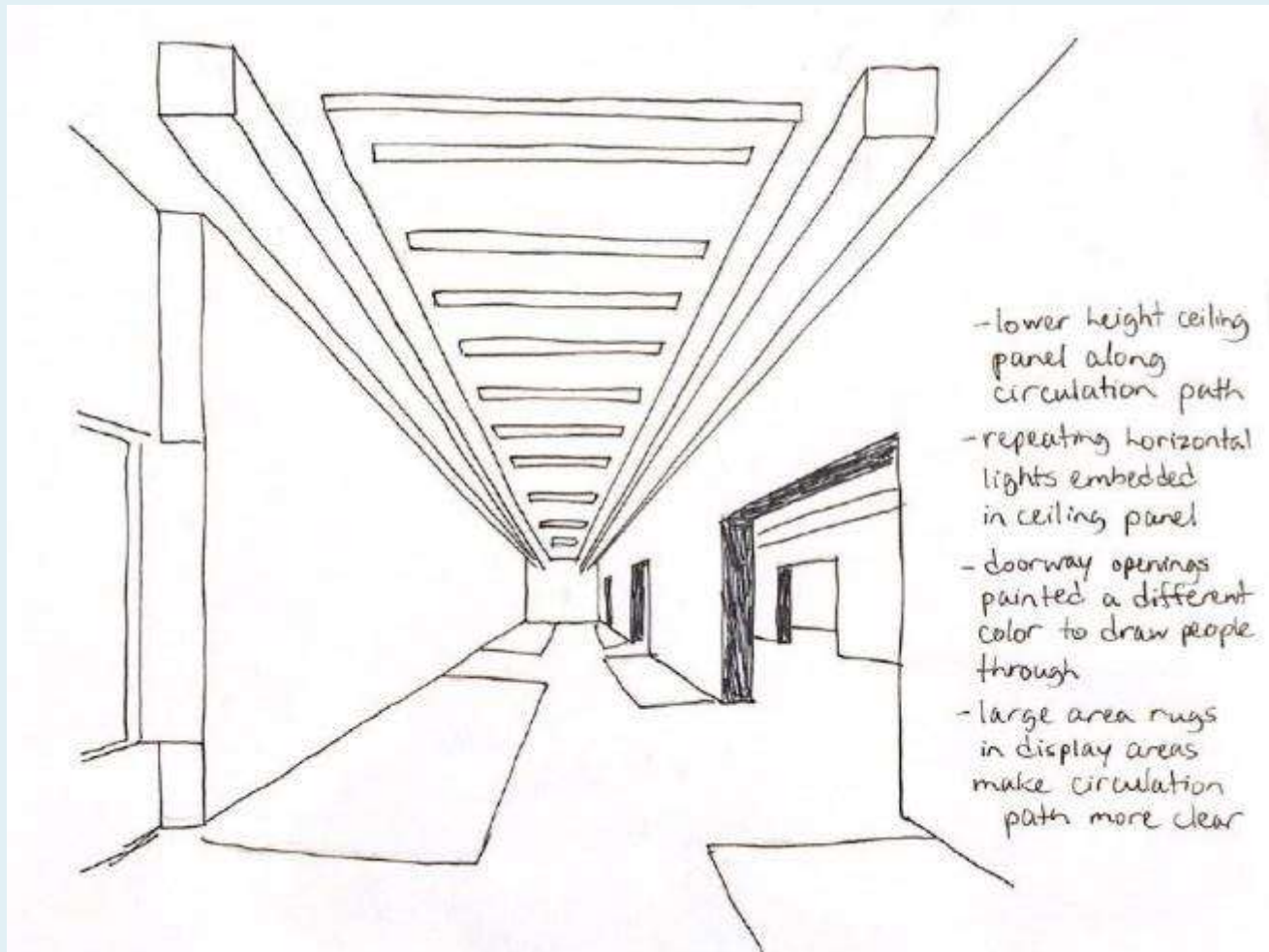

Perspective View

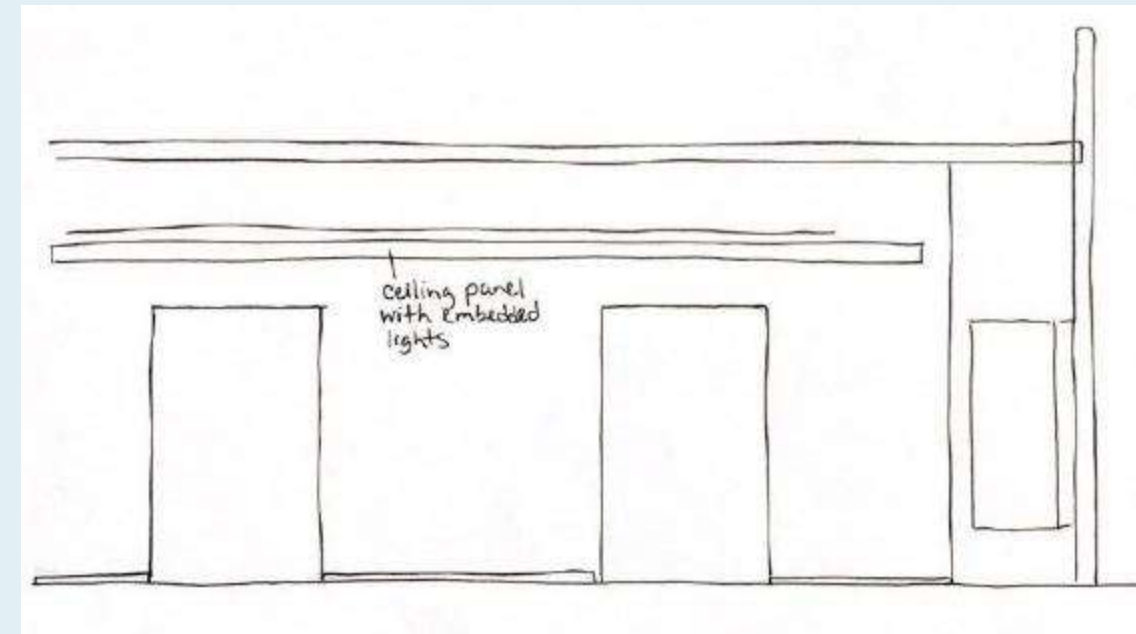

Section View

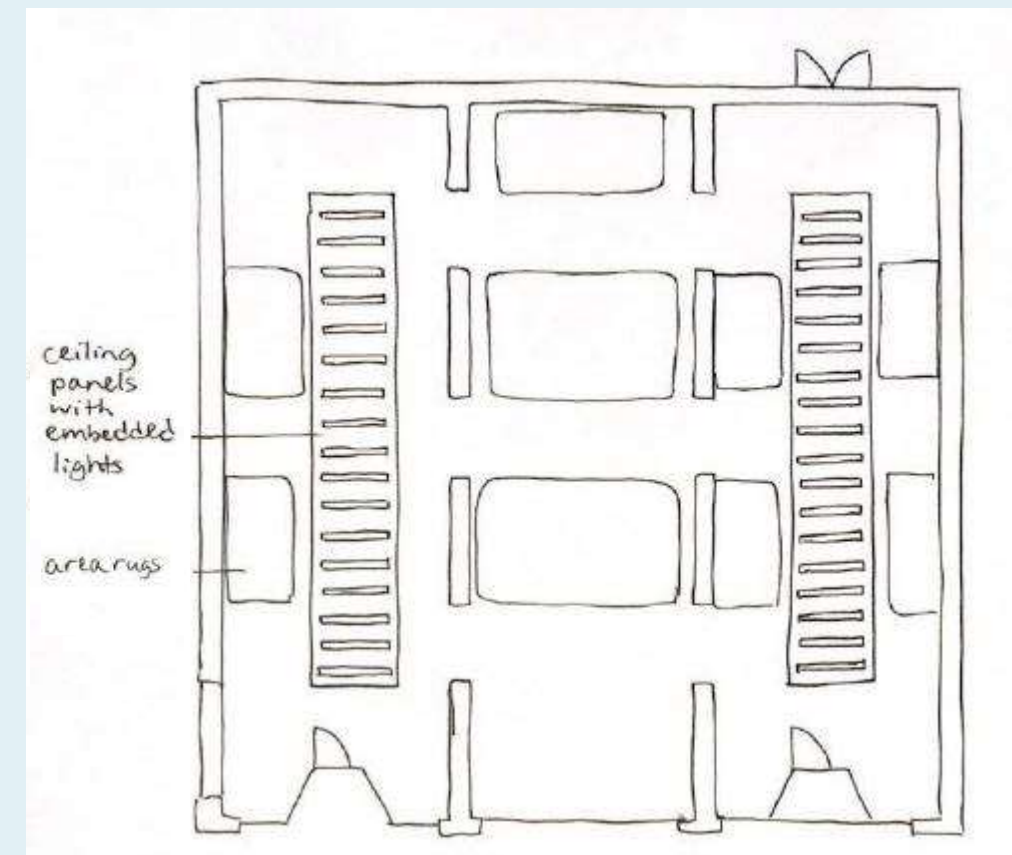

Plan View

# PROBLEM RESOLUTION SKETCHES

## - CEILING/DAYLIGHTING OPTION 1

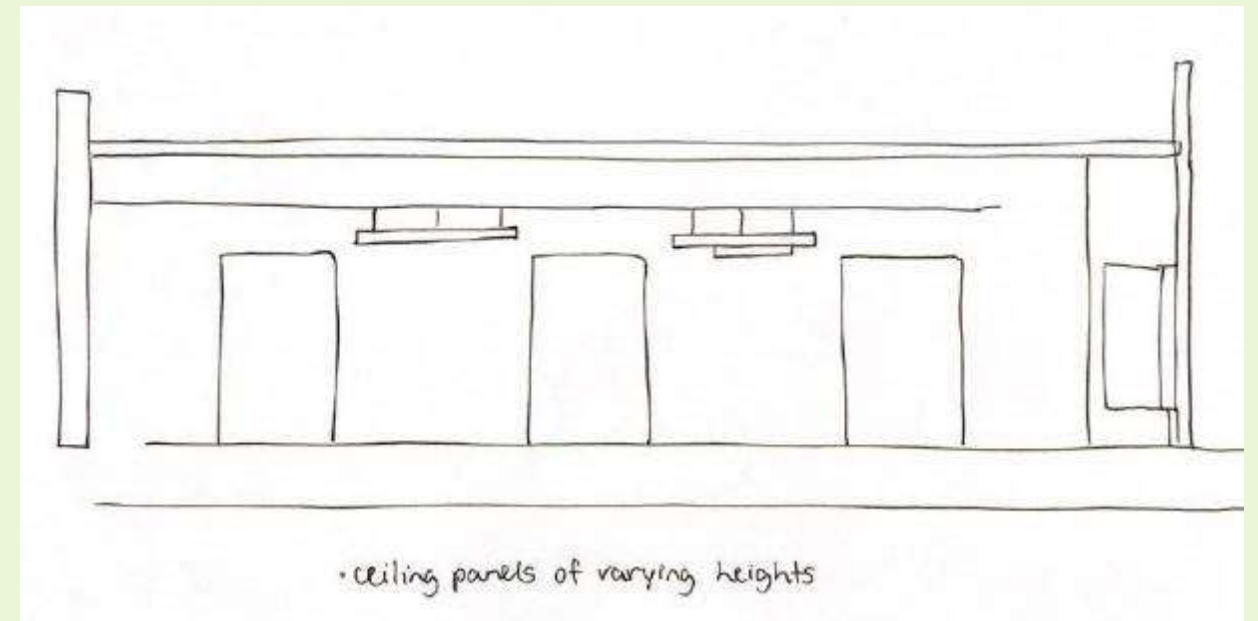

Section View

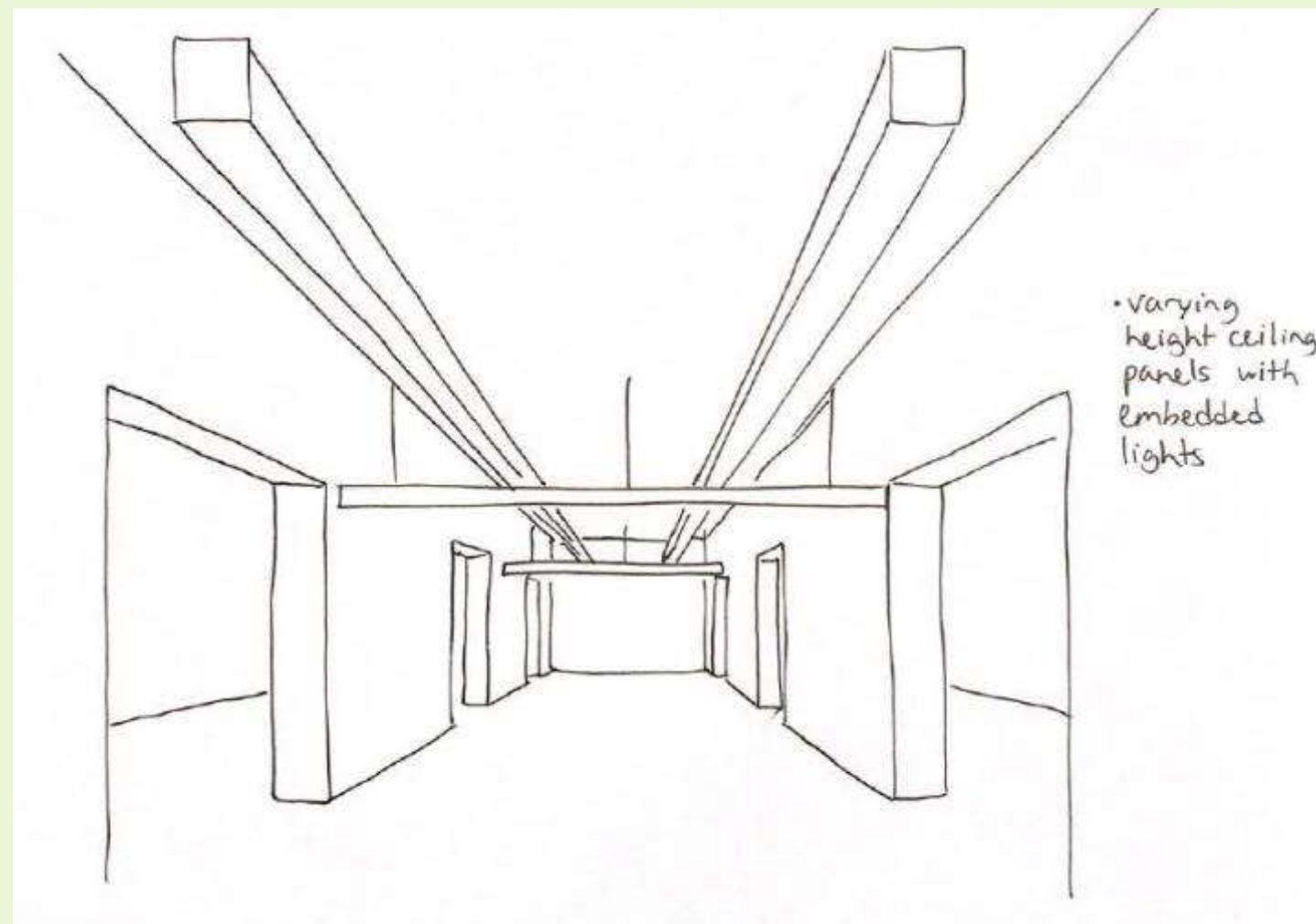

Perspective View

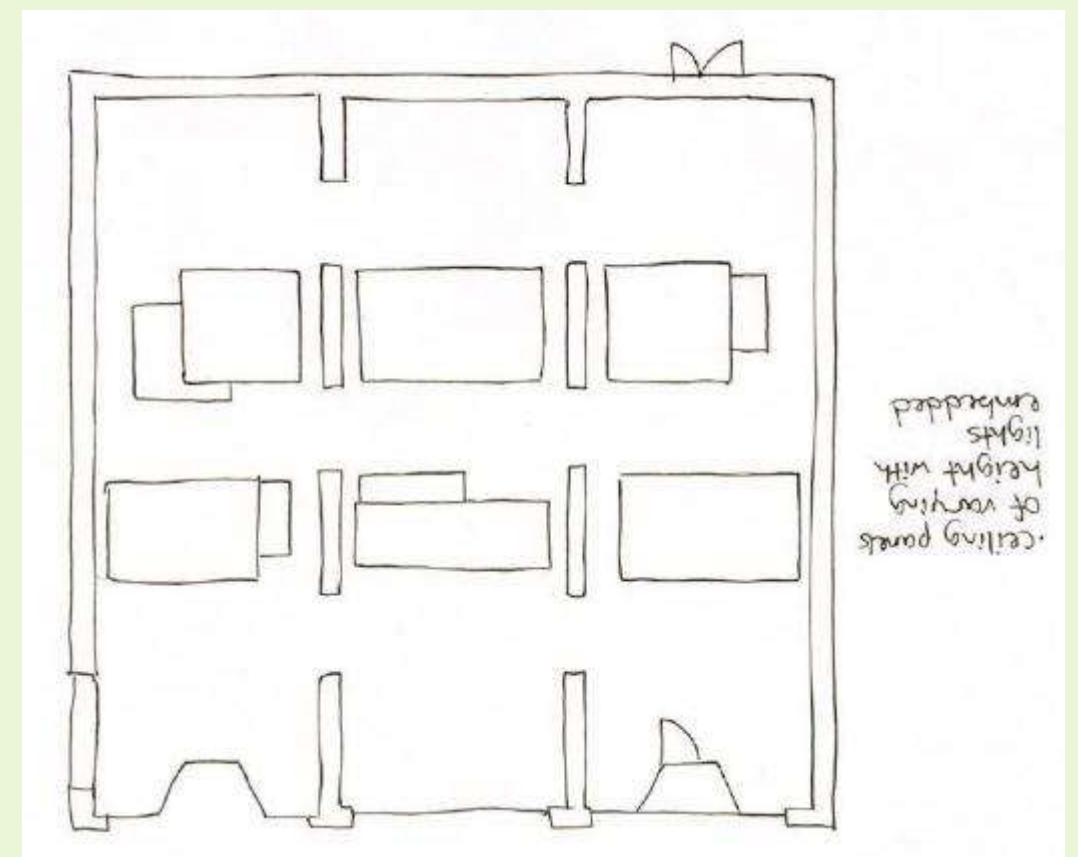

Plan View



# PROBLEM RESOLUTION SKETCHES

## - CEILING/DAYLIGHTING OPTION 2

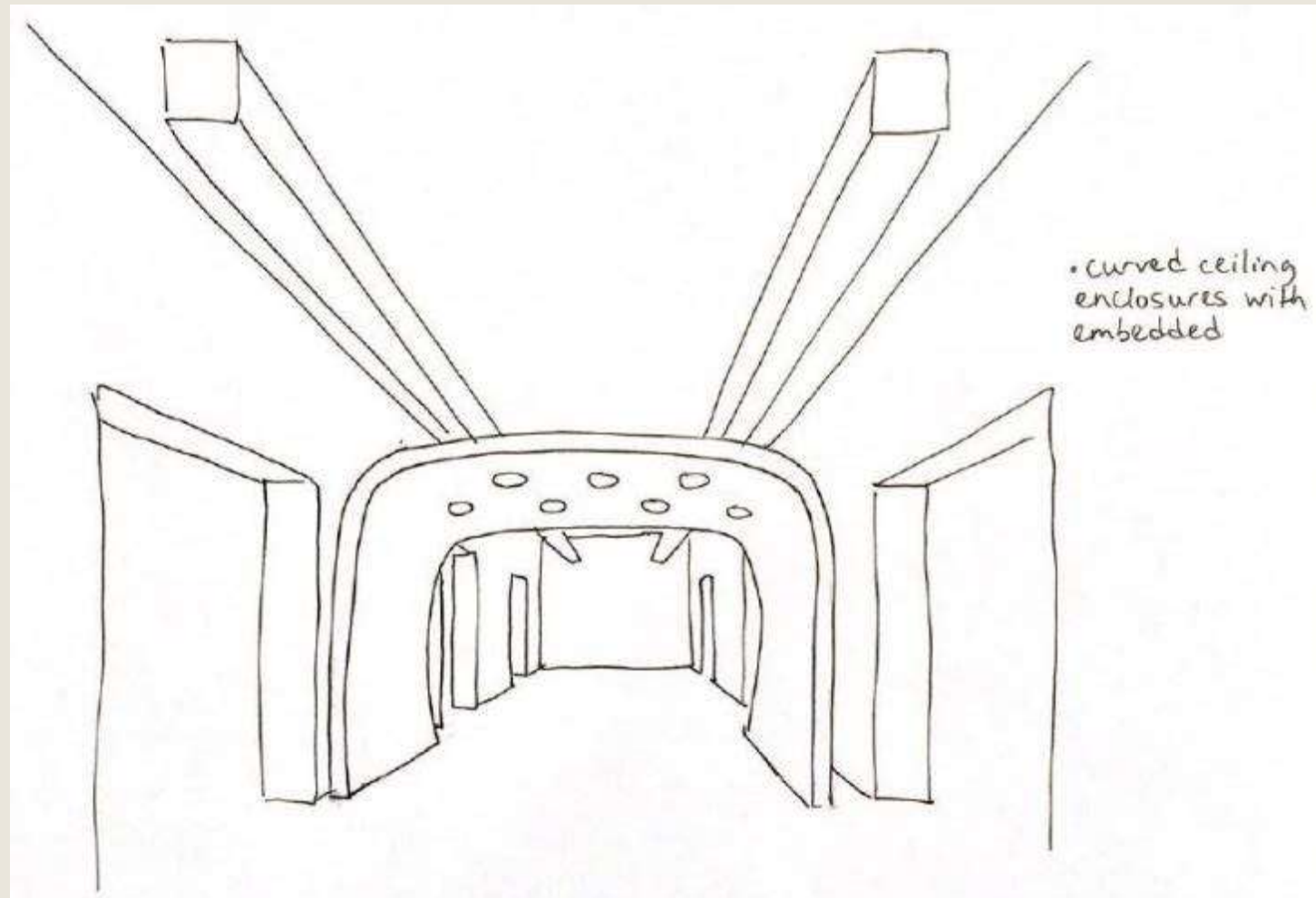

Perspective View

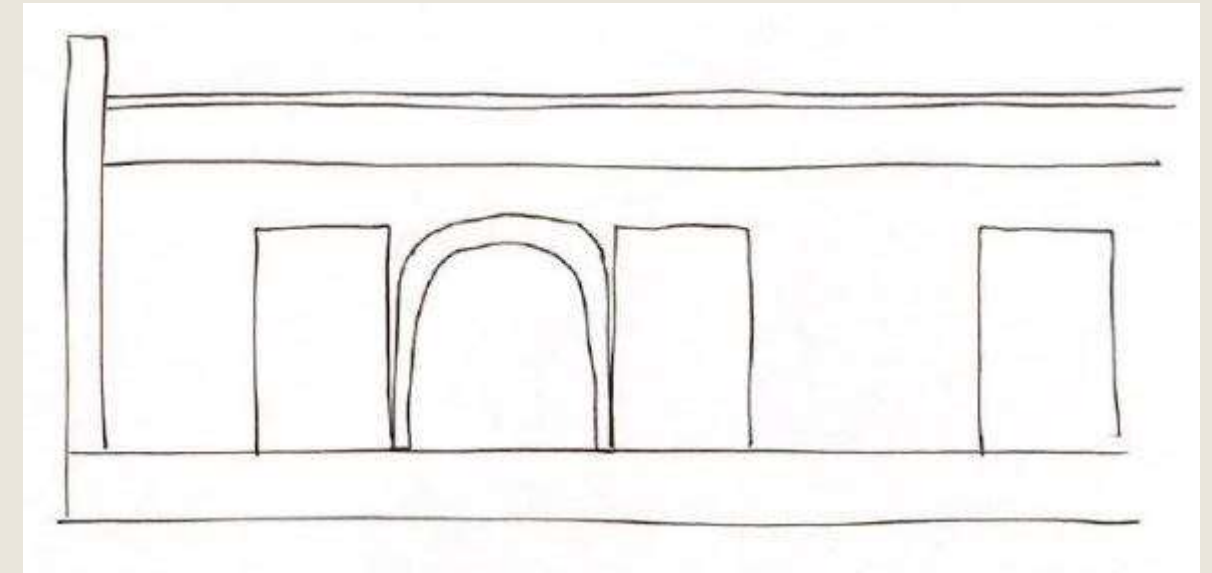

Section View

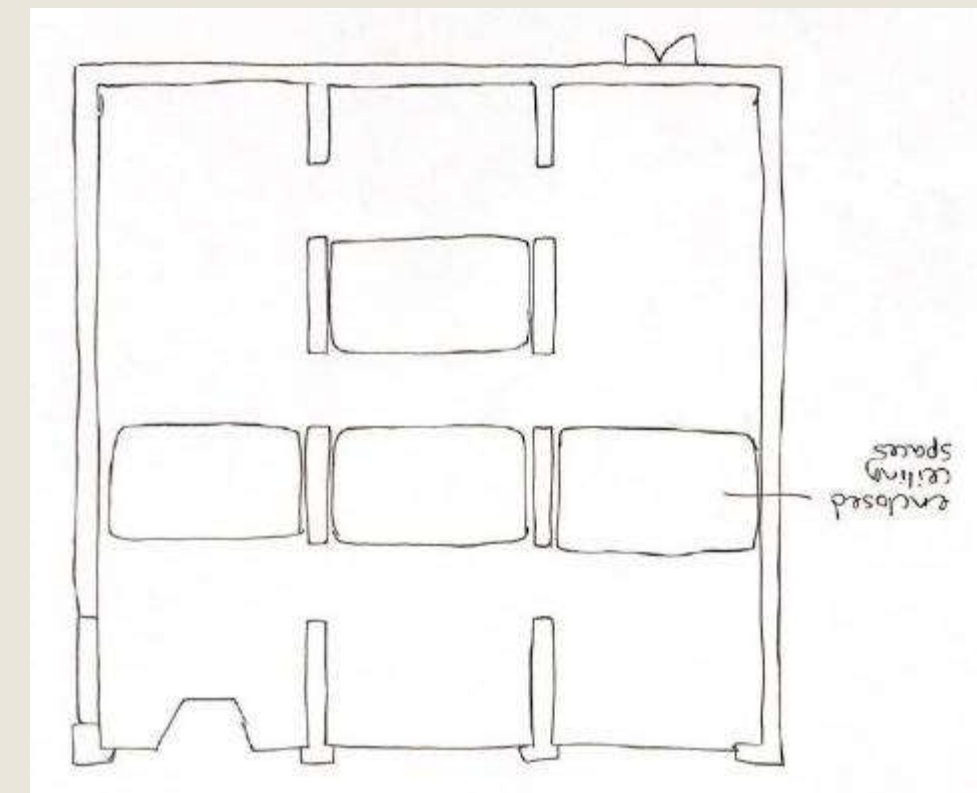

Plan View

# PROBLEM RESOLUTION SKETCHES

## - SUPPORT SPACES OPTION 1

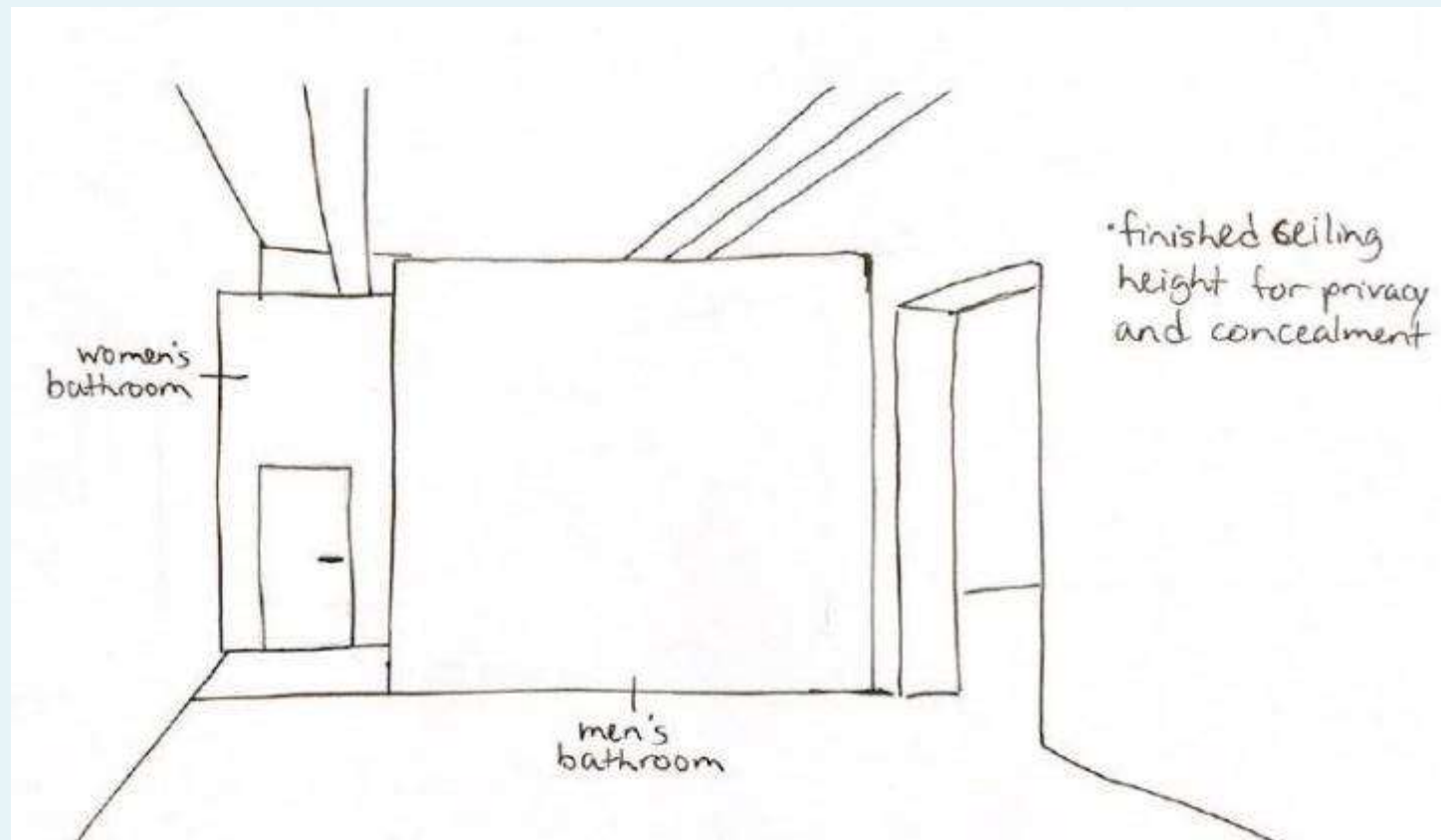

Perspective View

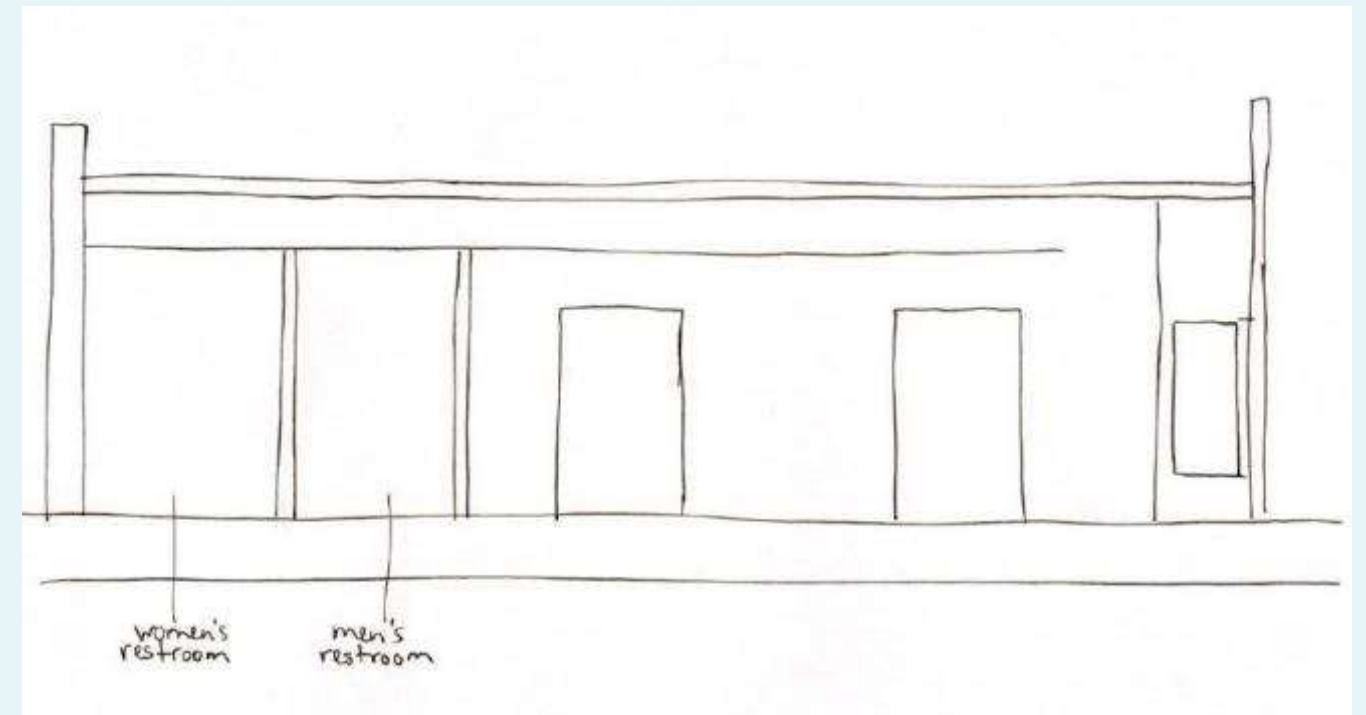

Section View

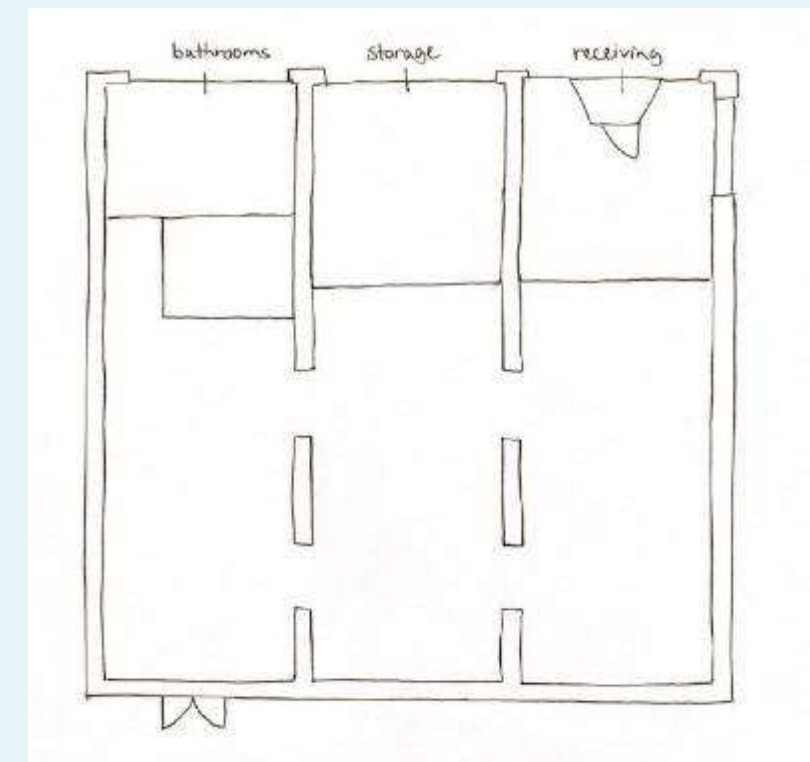

Plan View



# PROBLEM RESOLUTION SKETCHES

## - SUPPORT SPACES OPTION 2

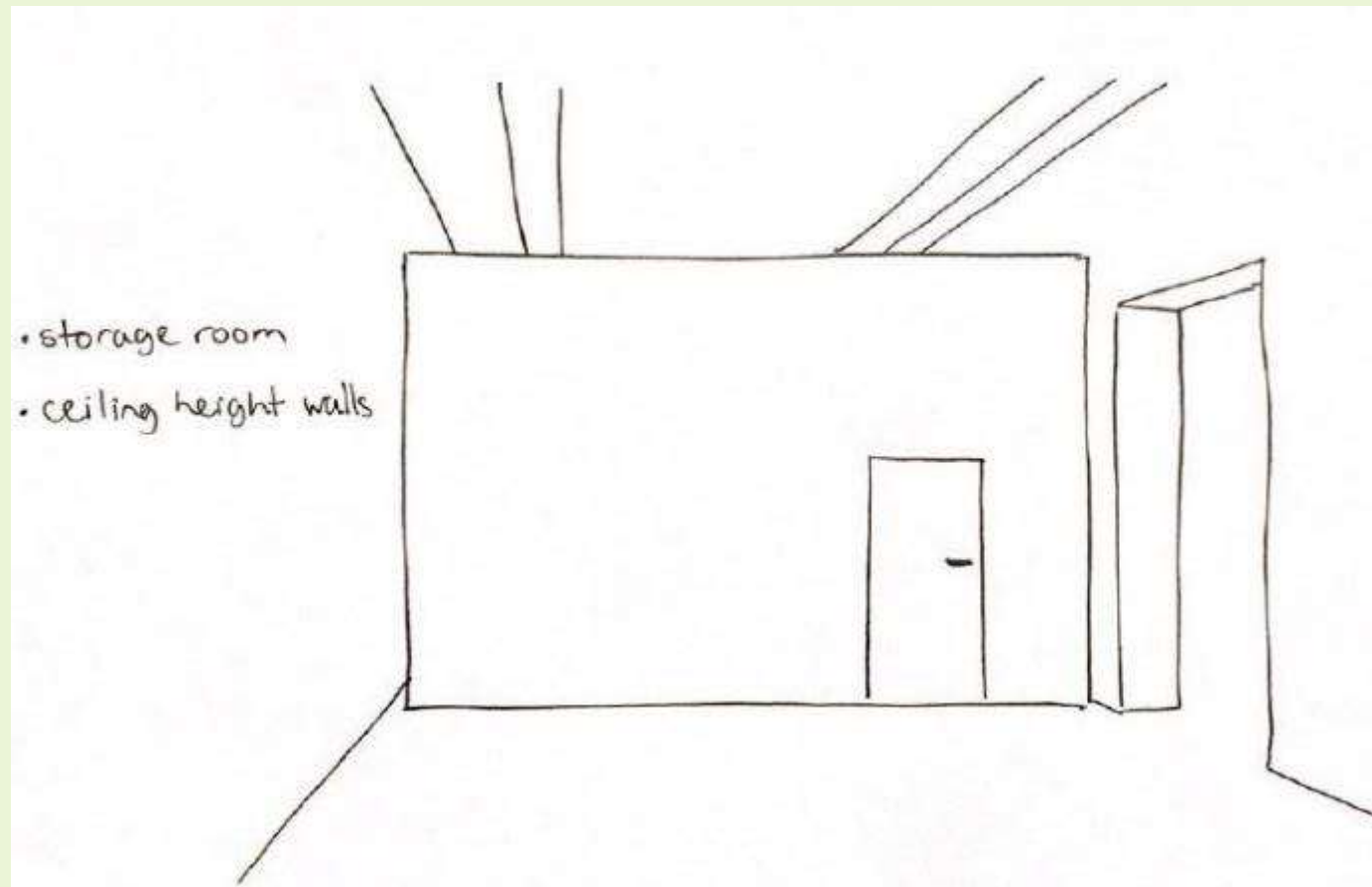

Perspective View

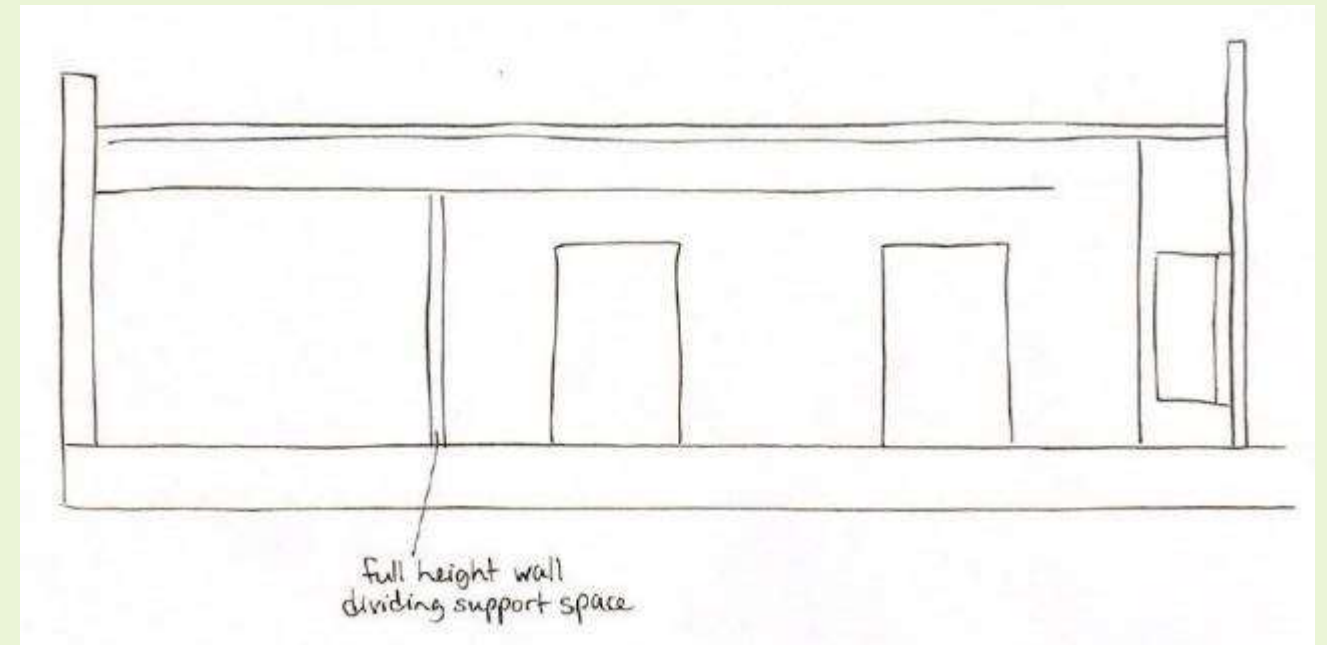

Section View

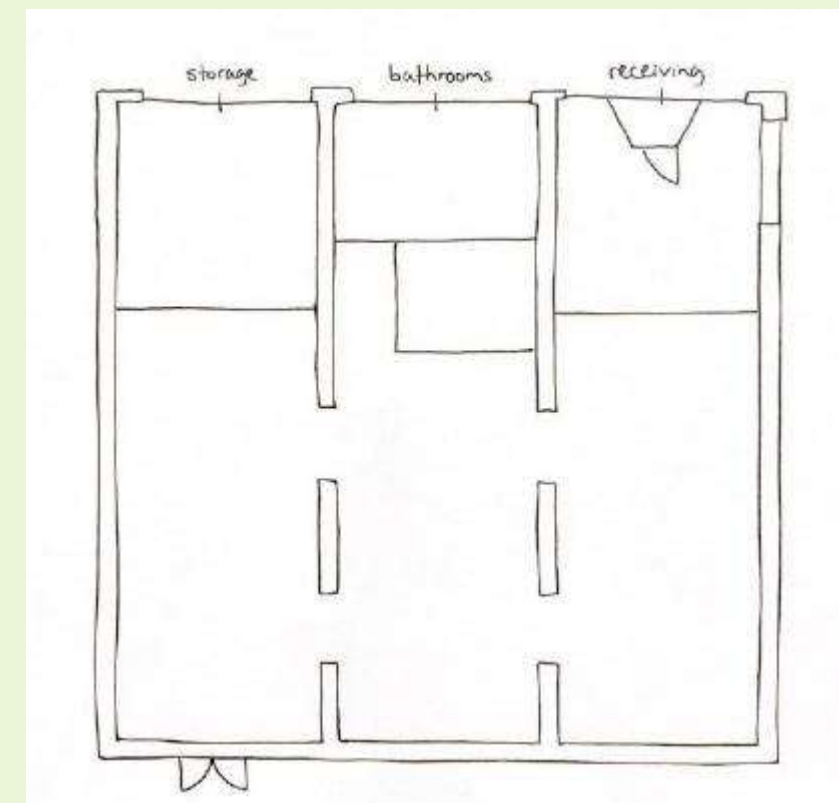

Plan View

# DESIGN SYNTHESIS STUDIES

- ENTRY

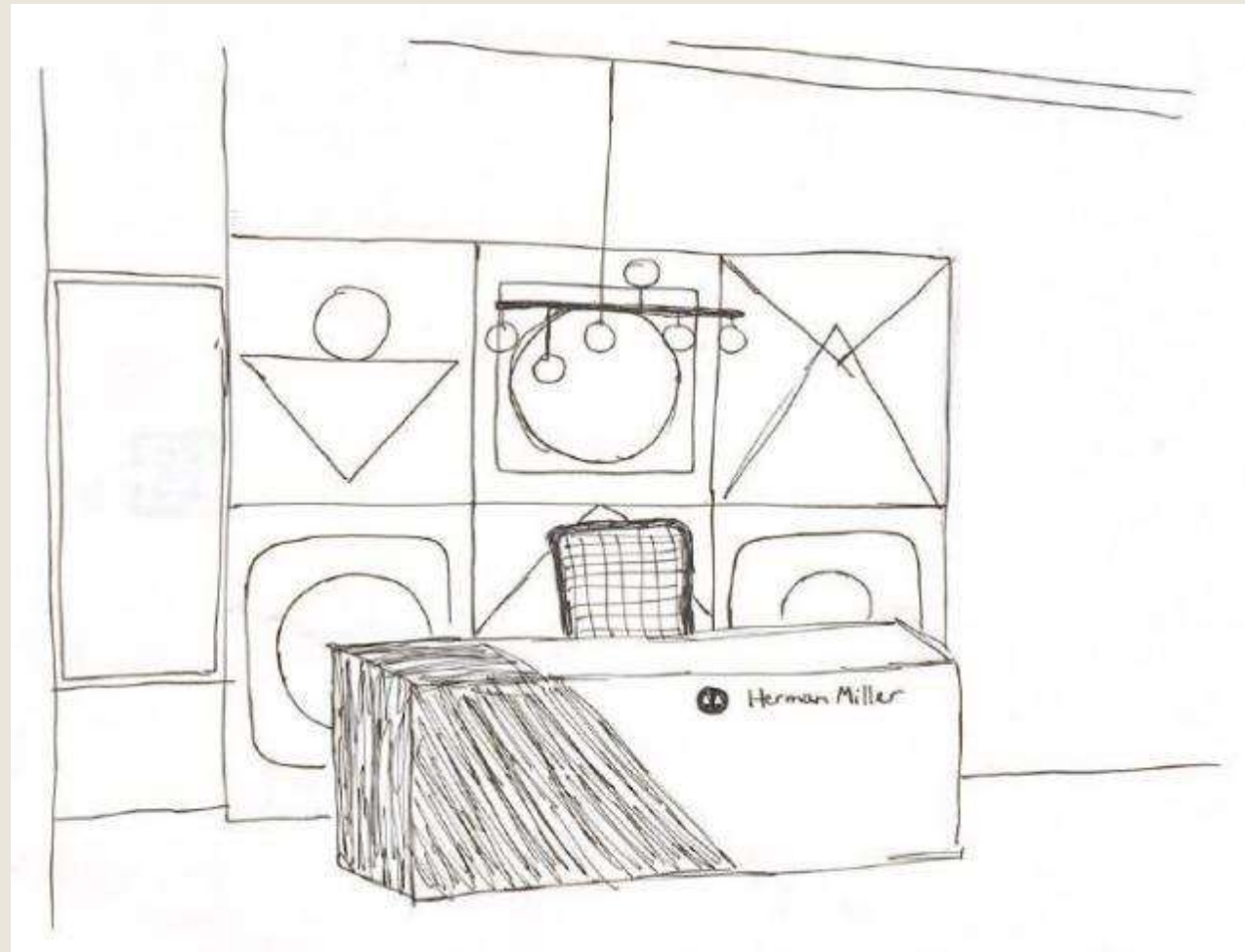

View 1

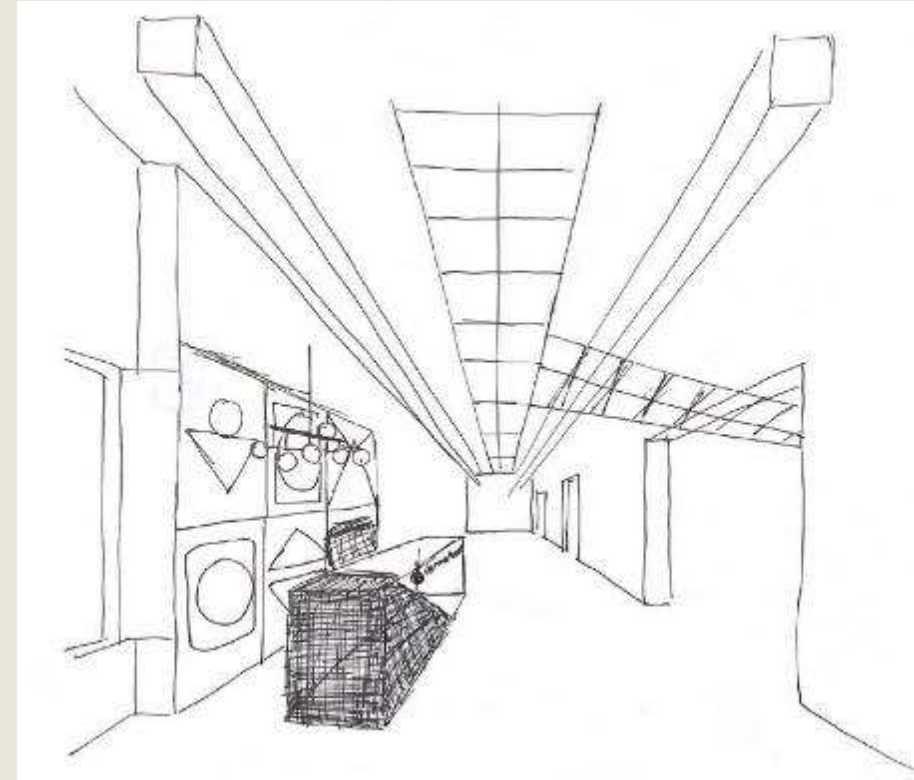

View 2

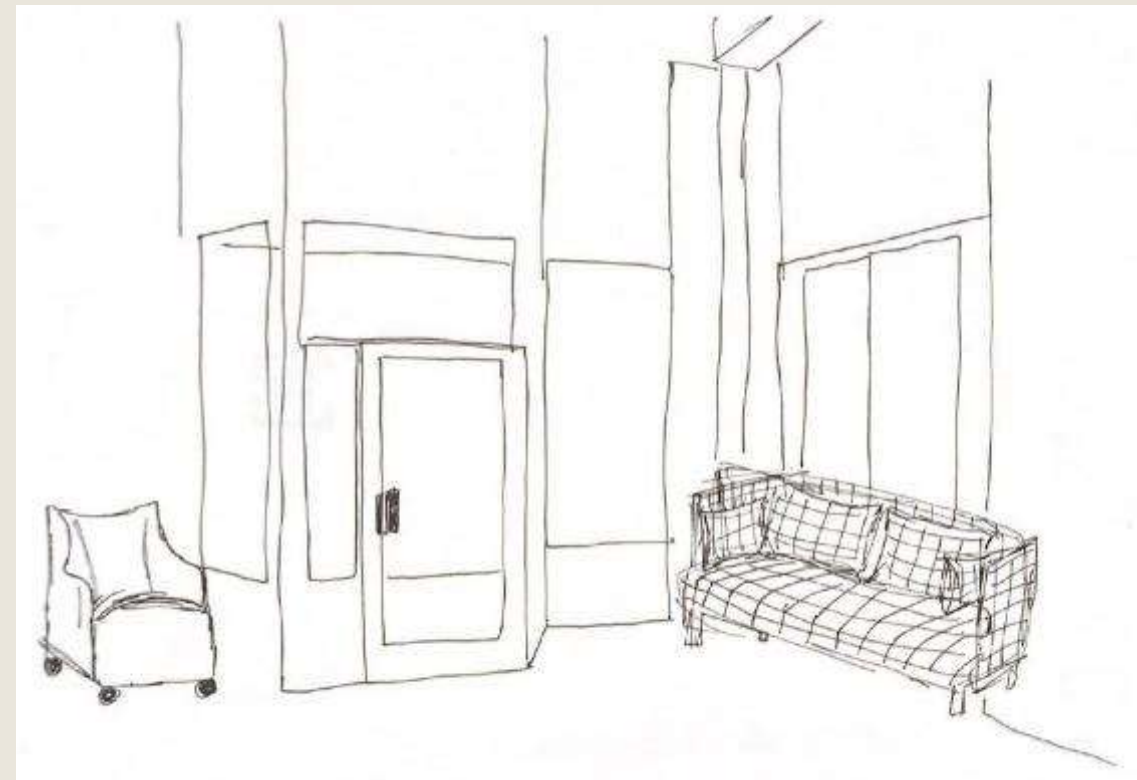

View 3



# DESIGN SYNTHESIS STUDIES

## - LOUNGE

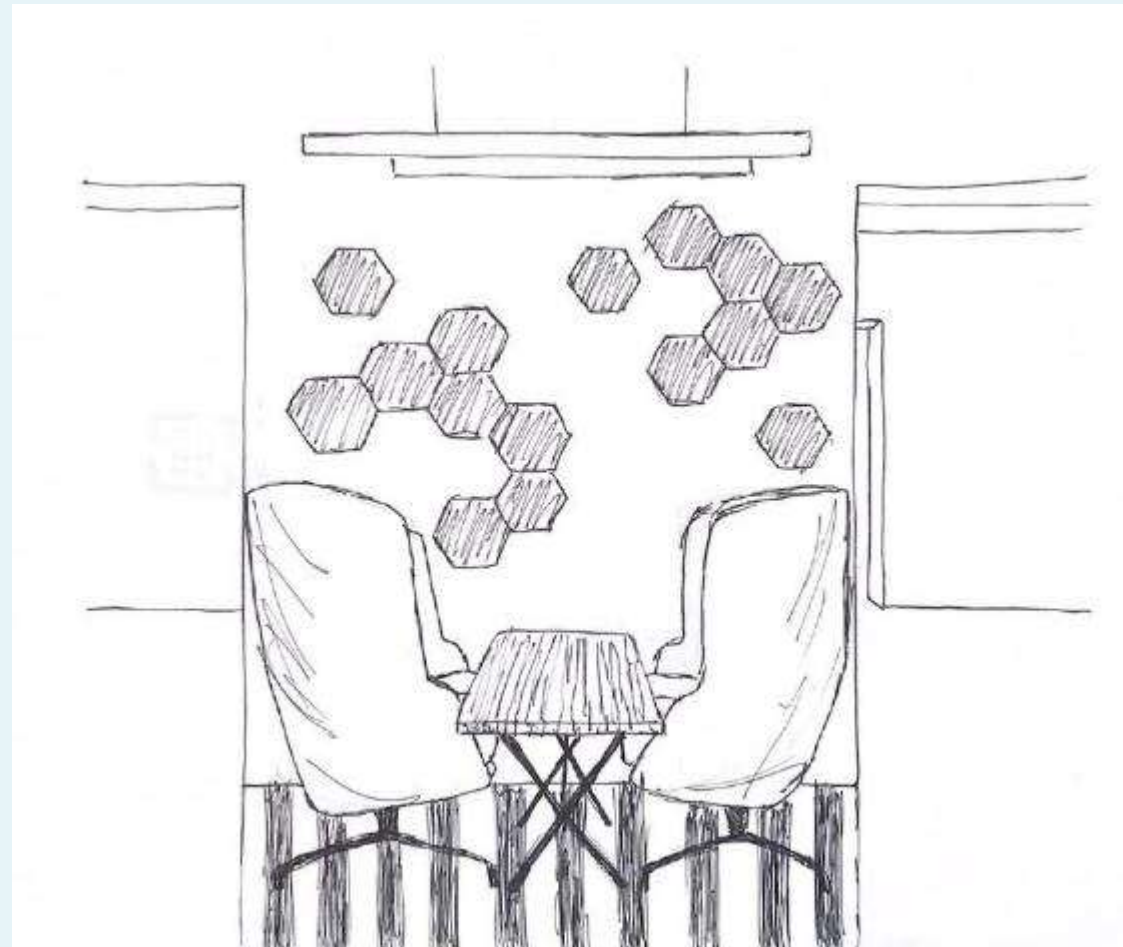

View 1

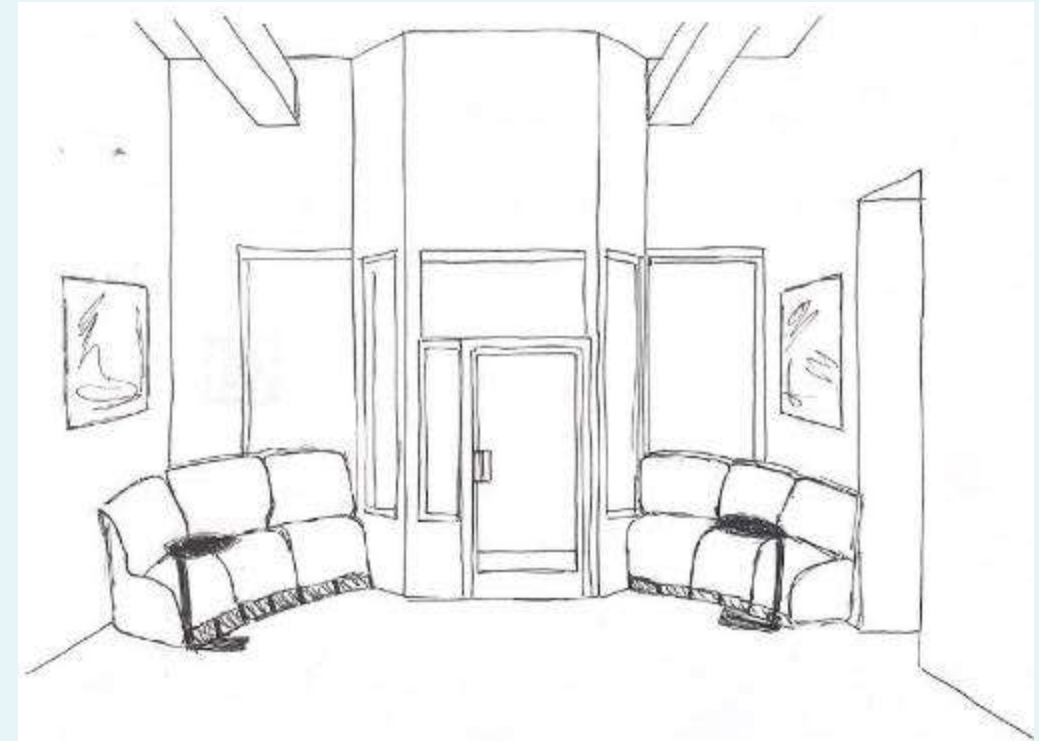

View 2

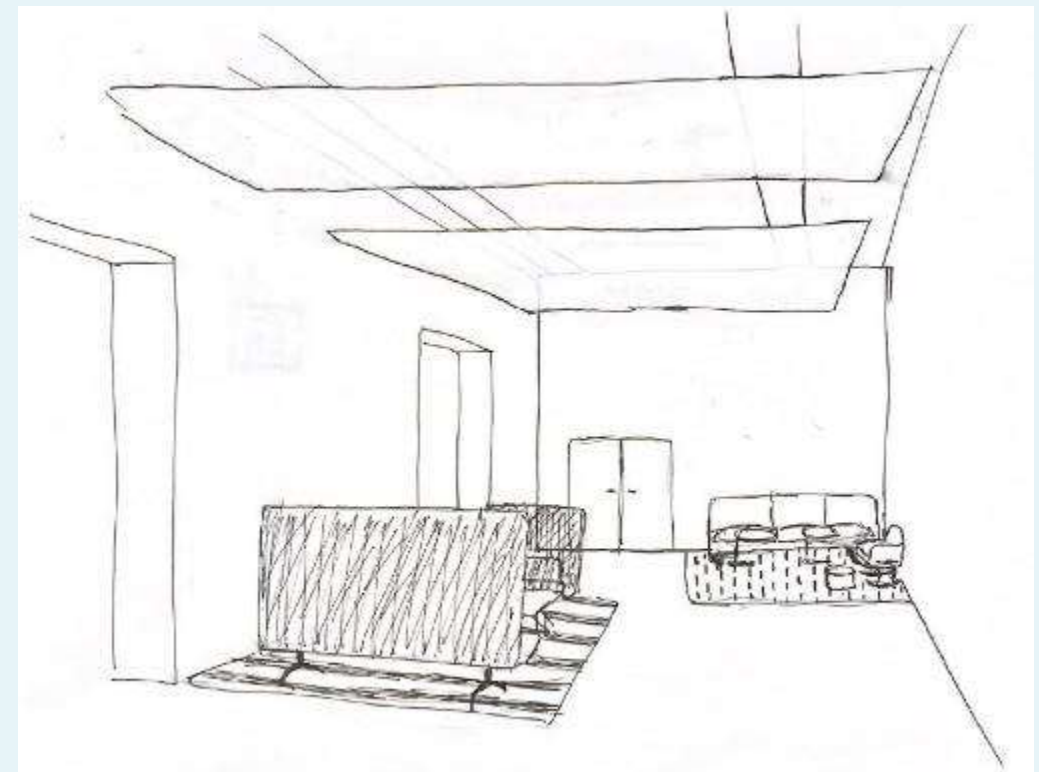

View 3

# DESIGN SYNTHESIS STUDIES

## - SERVICE COUNTER

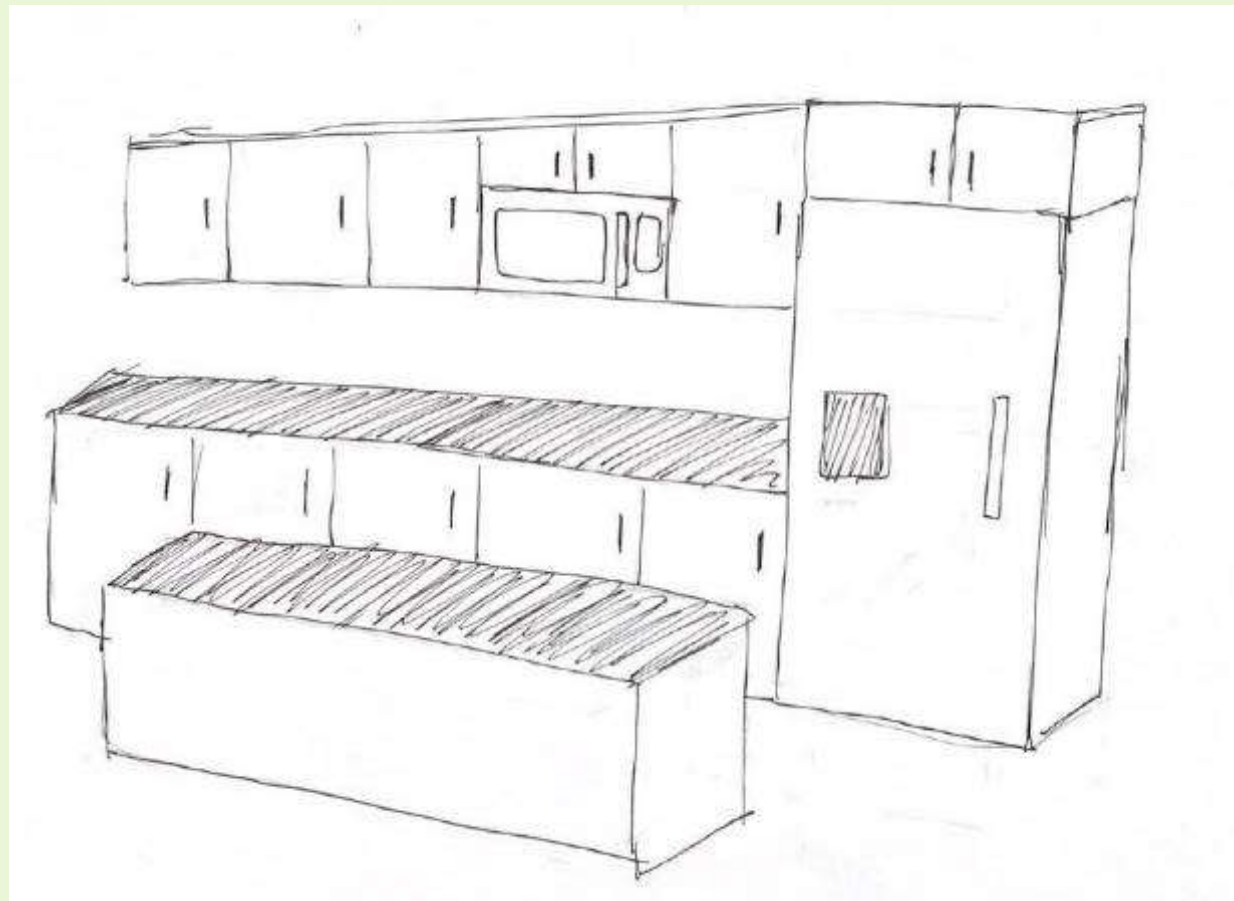

View 1

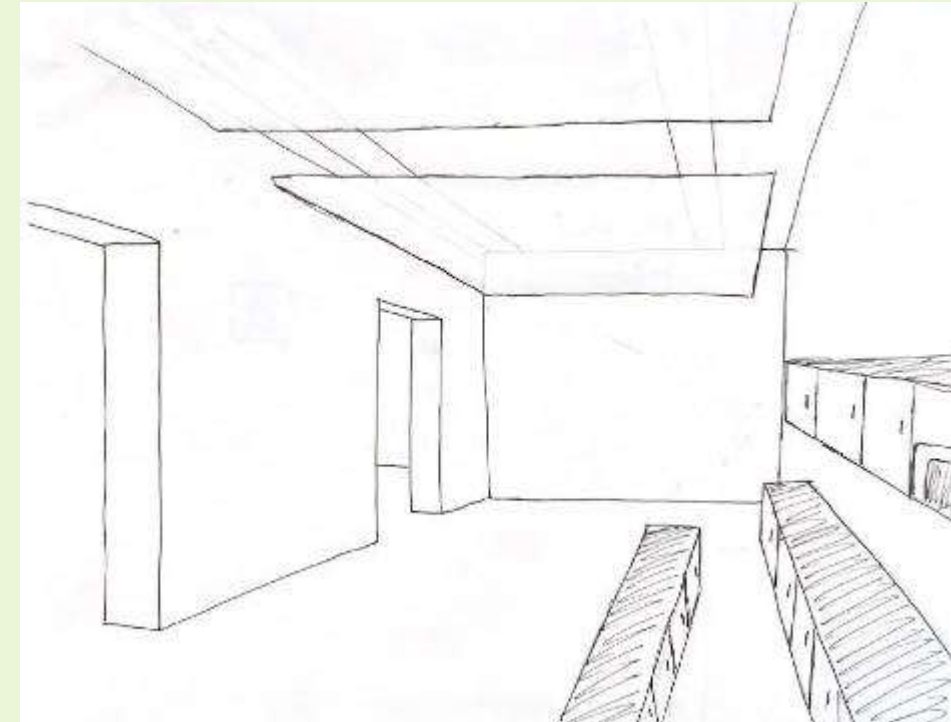

View 2

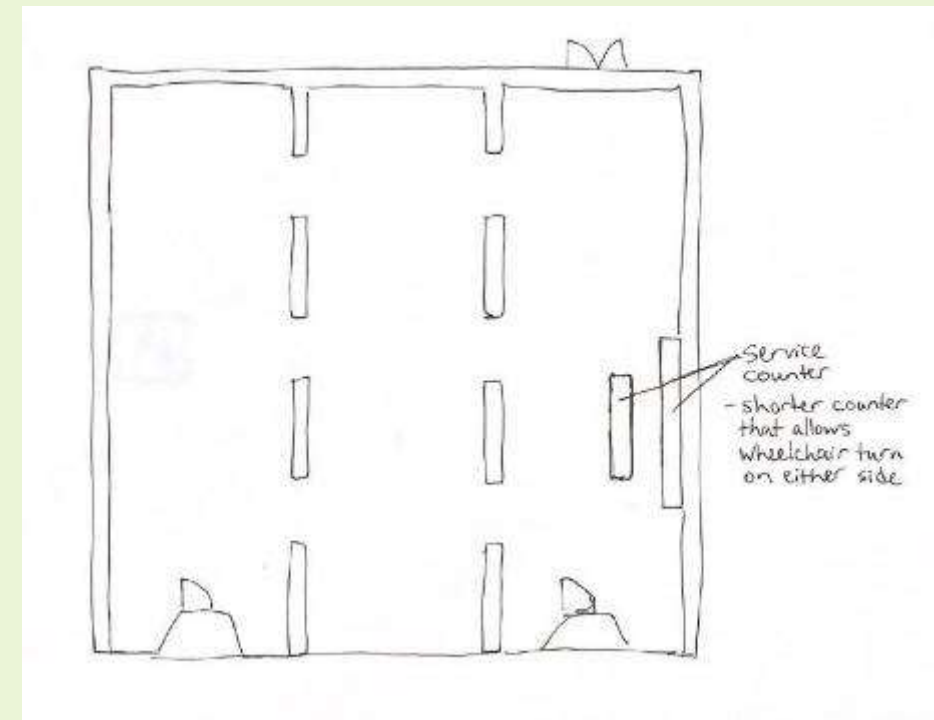

Plan View

# DESIGN SYNTHESIS STUDIES

## - OPEN WORK AREA

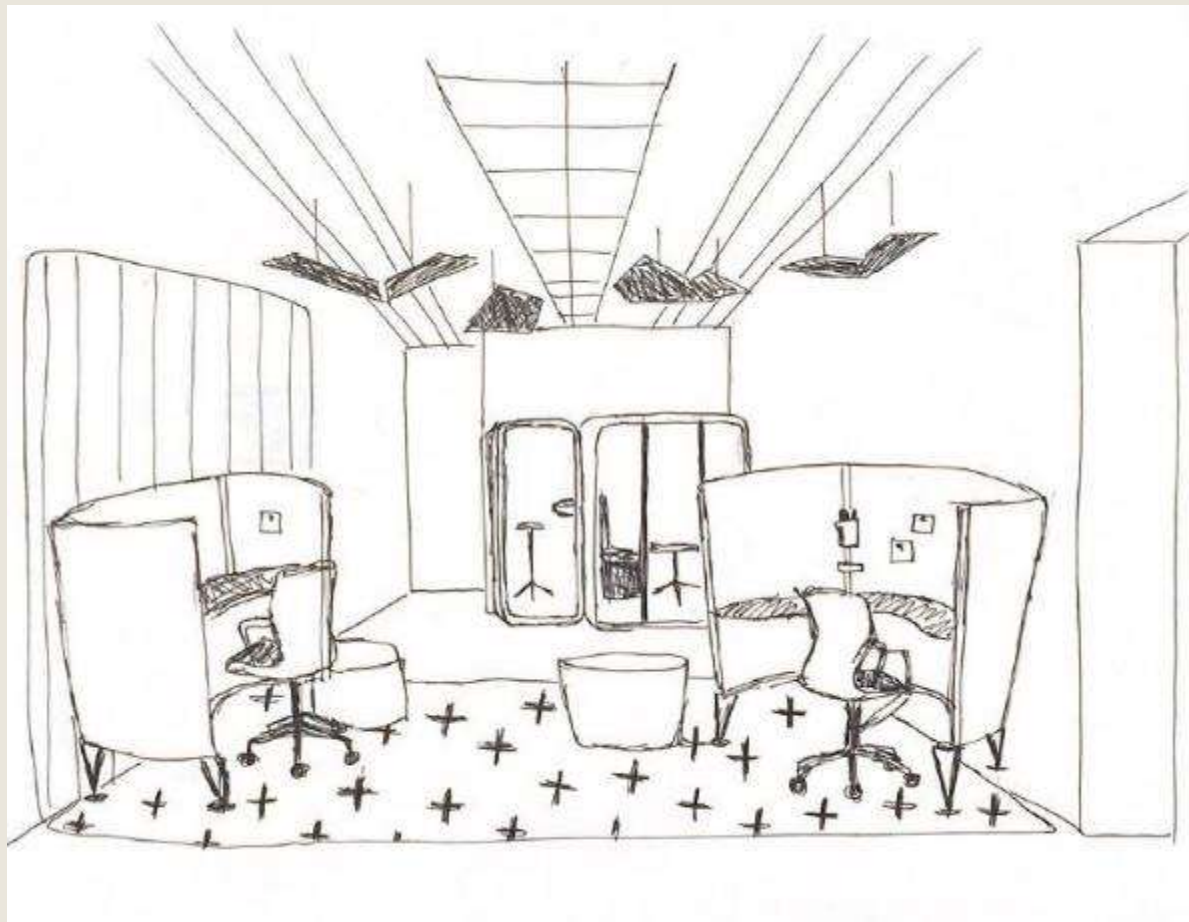

View 1



View 2

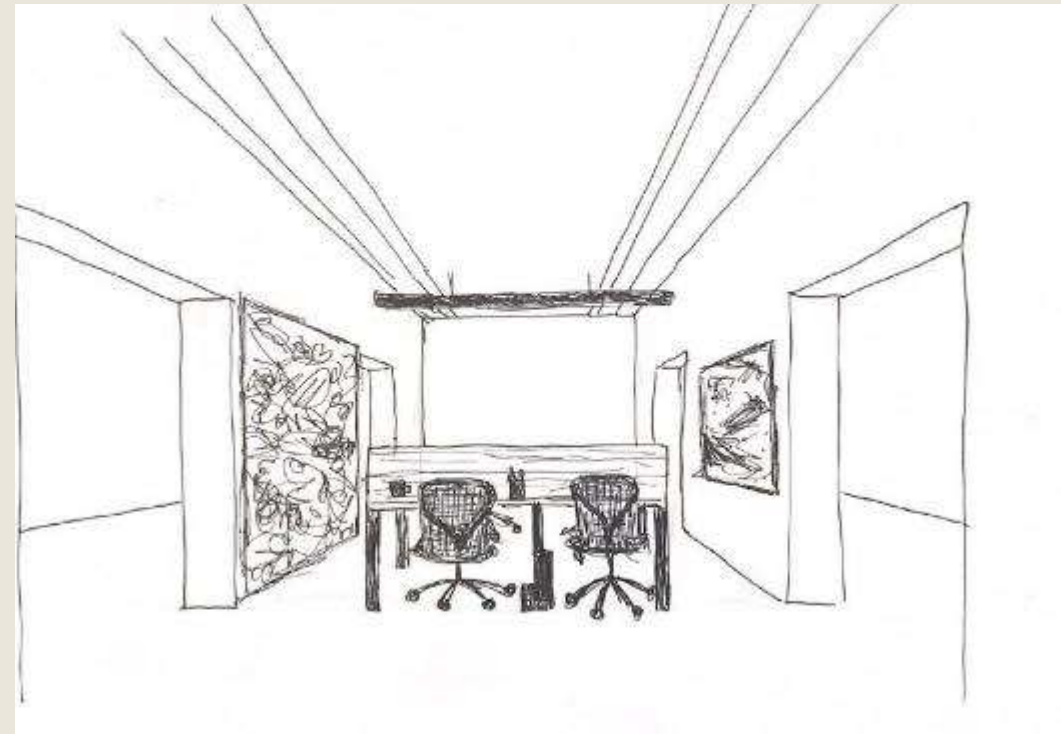

View 3



# FURNITURE AND FINISH PALETTES

## - OPTION 1



# FURNITURE AND FINISH PALETTES

## - OPTION 2



# LIGHTING MODEL



View 1



View 2

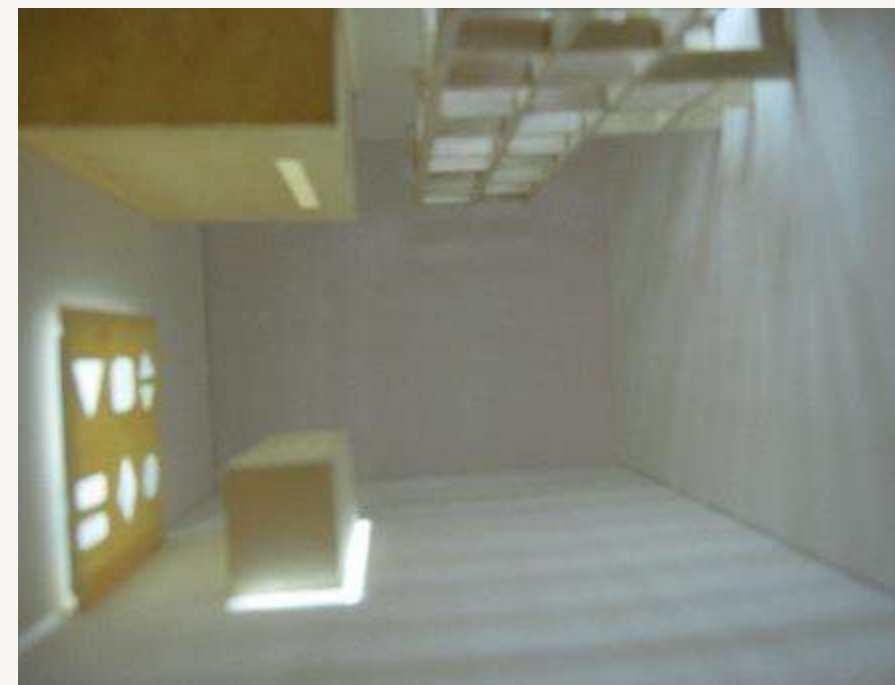

View 3