

PORTFOLIO II

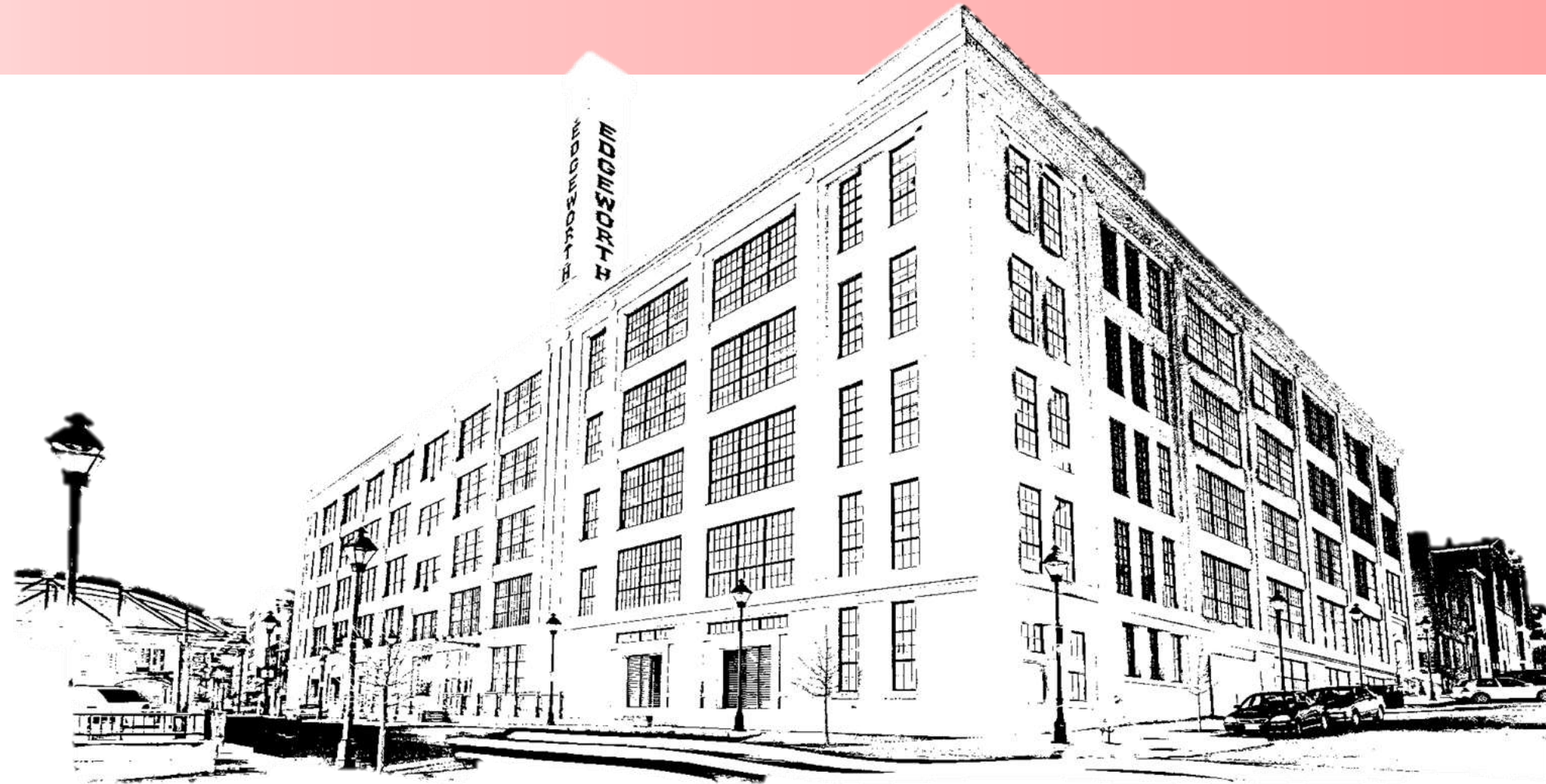

PRELIMINARY SCHEMATICS
AMBER COUSAR
IDSN 3202
SPRING 2020

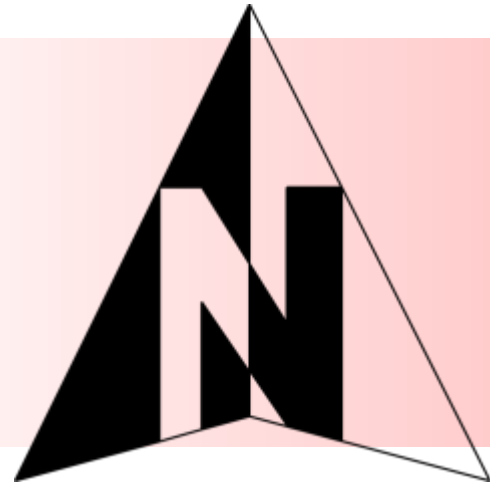

CIRCULATION PLANS

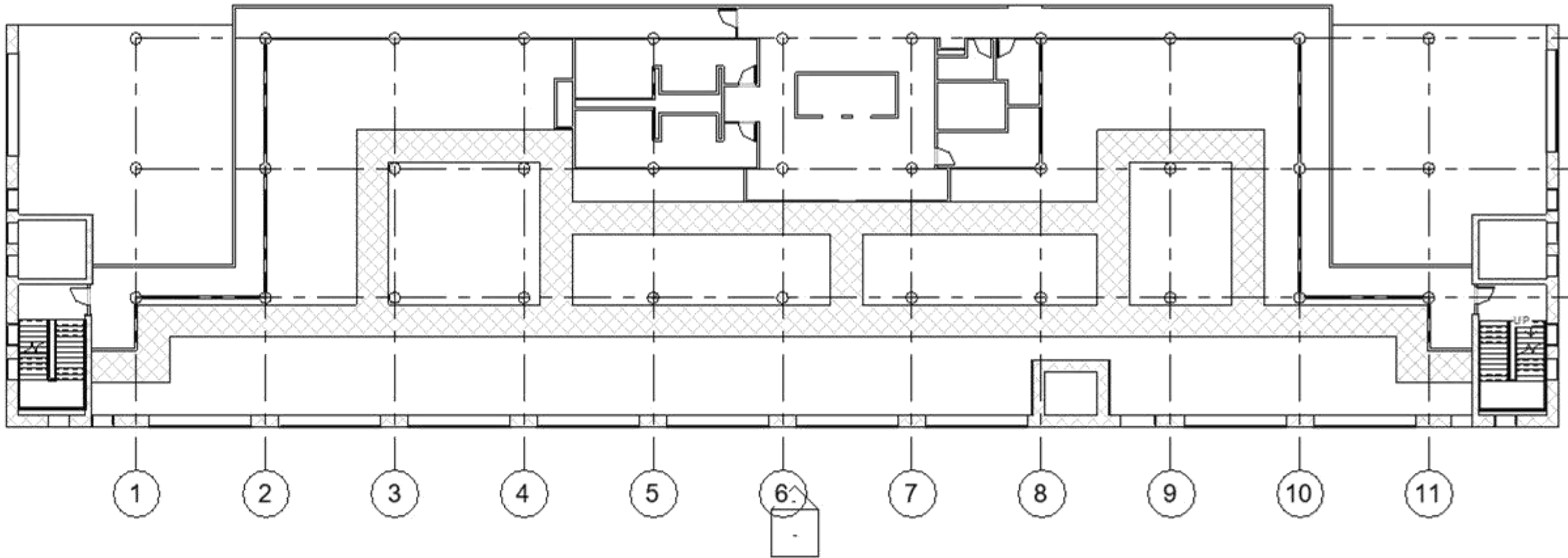

OPTION 1

SCALE: 1/16"=1'-0"

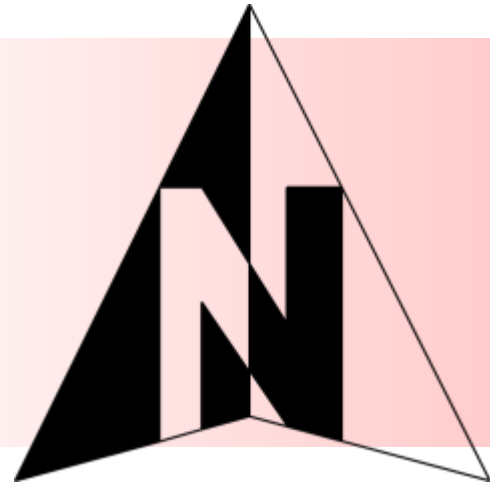

CIRCULATION PLANS

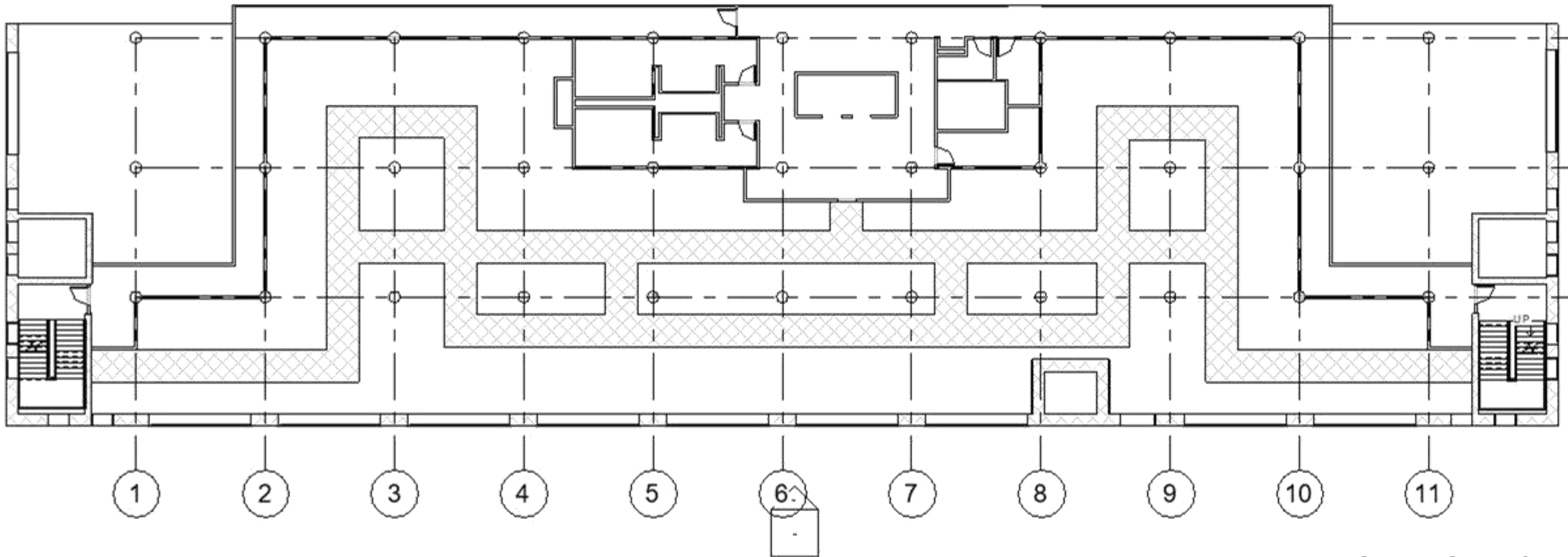

OPTION 2

SCALE: 1/16"=1'-0"

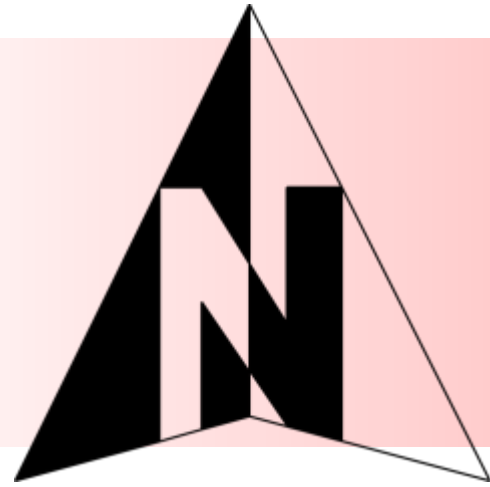

SYSTEMS RCP

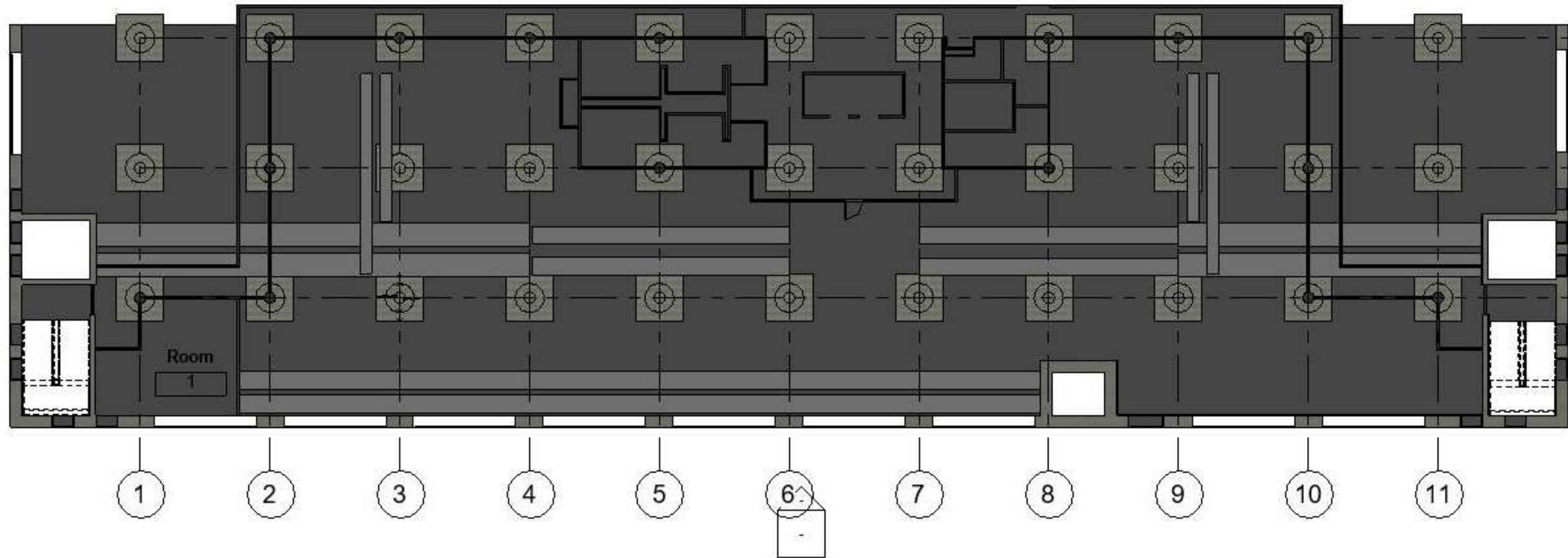

SCALE: 1/16"=1'-0"

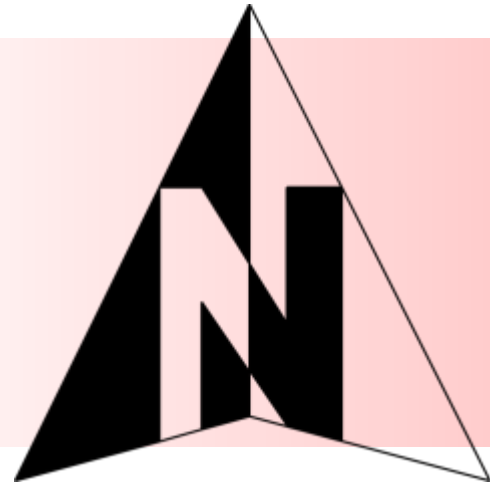

SPACE PLAN SKETCHES

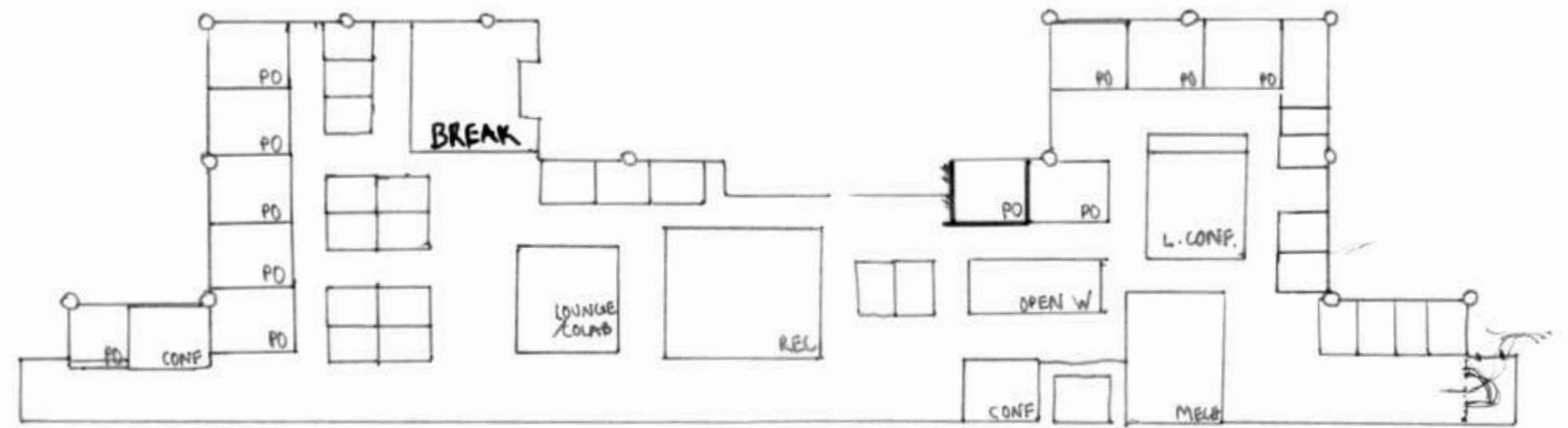
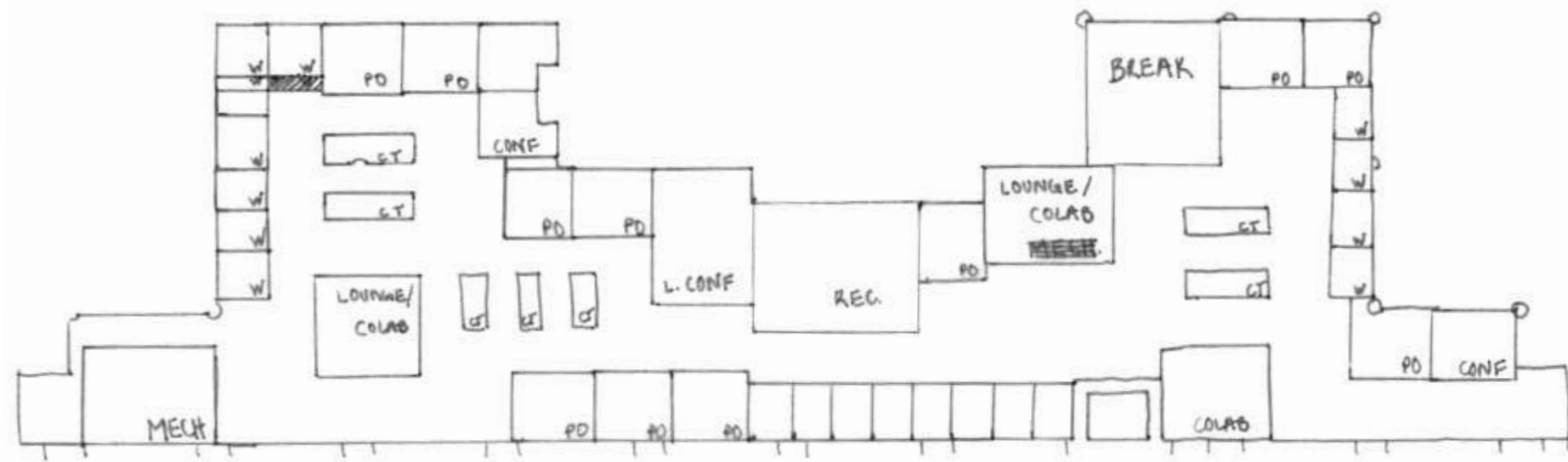

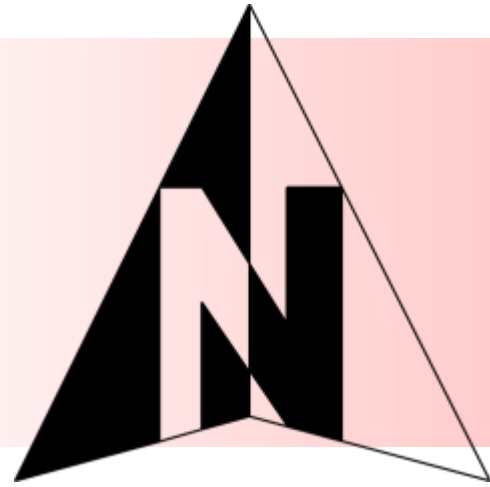

SPACE PLAN SKETCHES

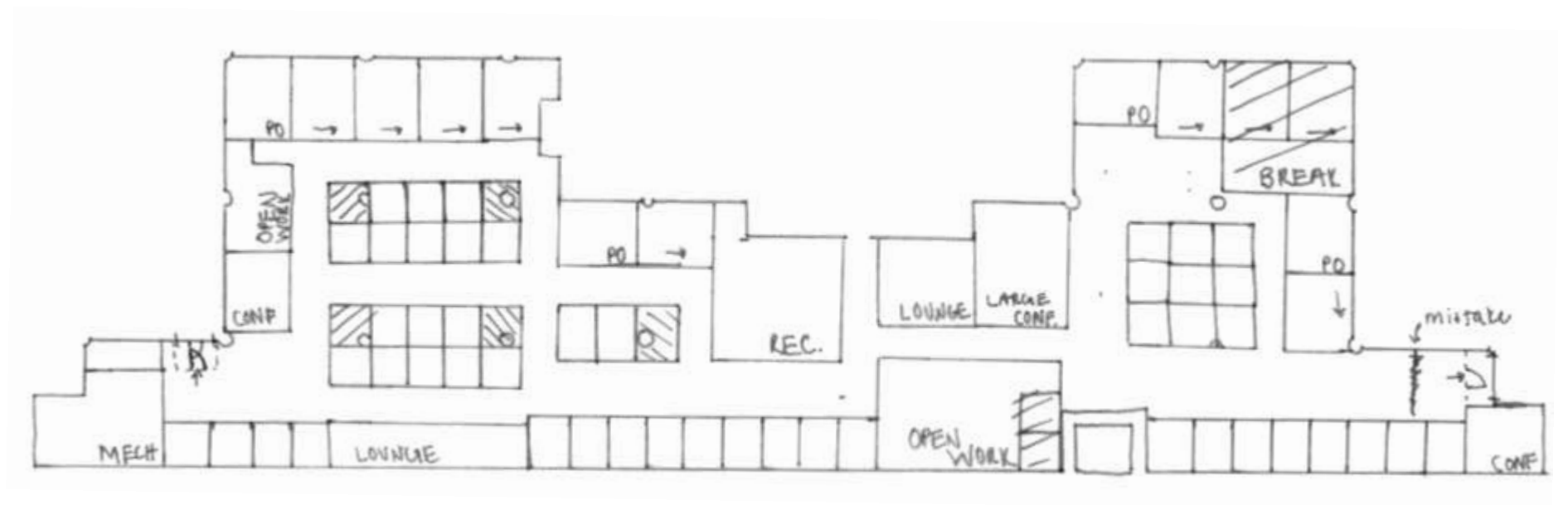
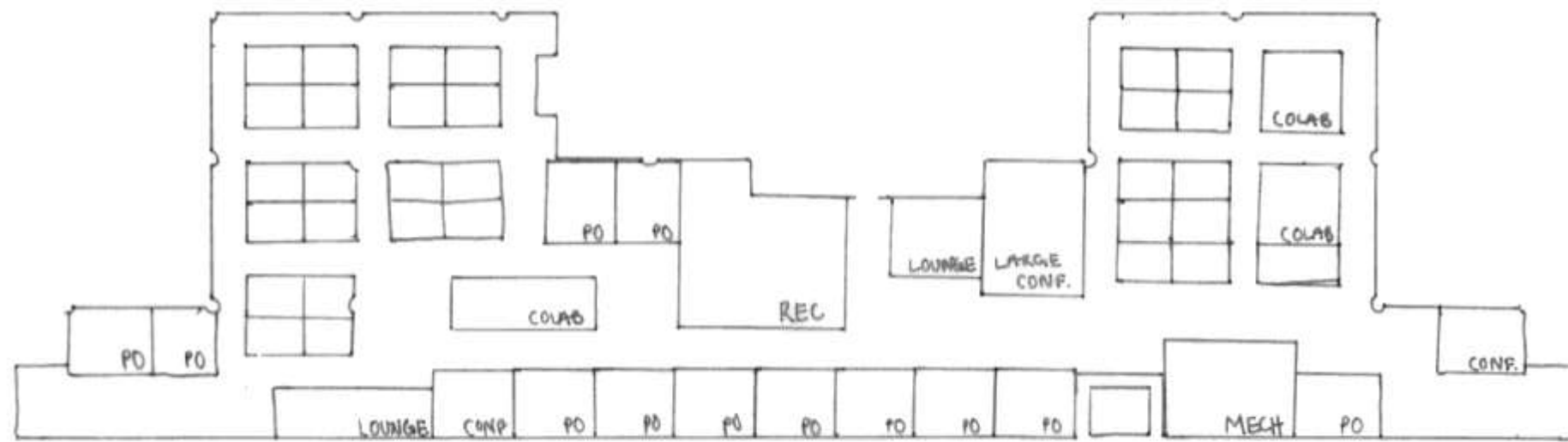

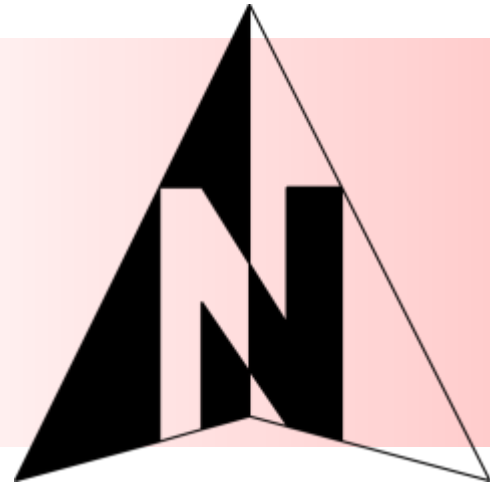

SPACE PLAN SKETCHES

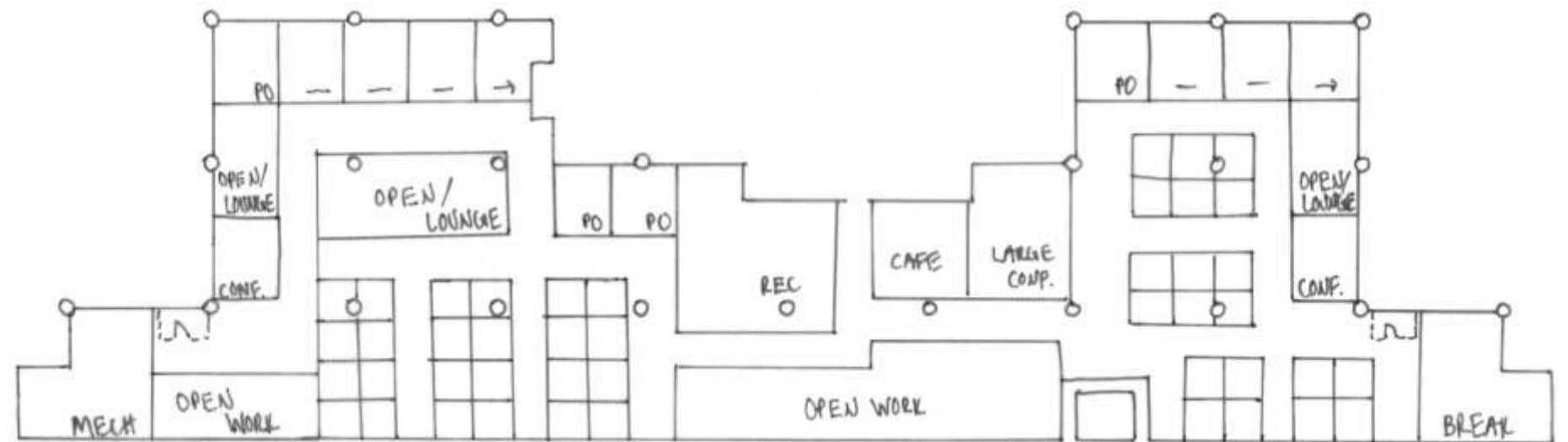

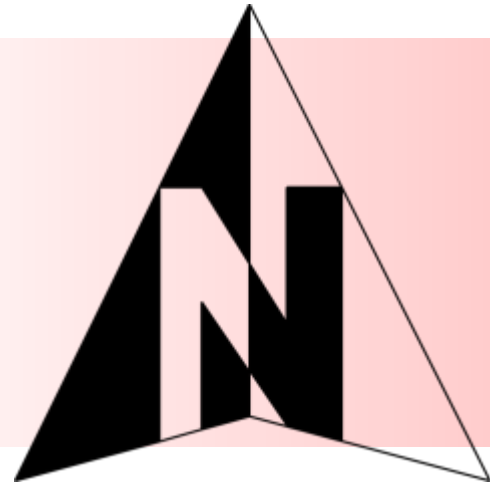

SPACE PLAN SKETCHES

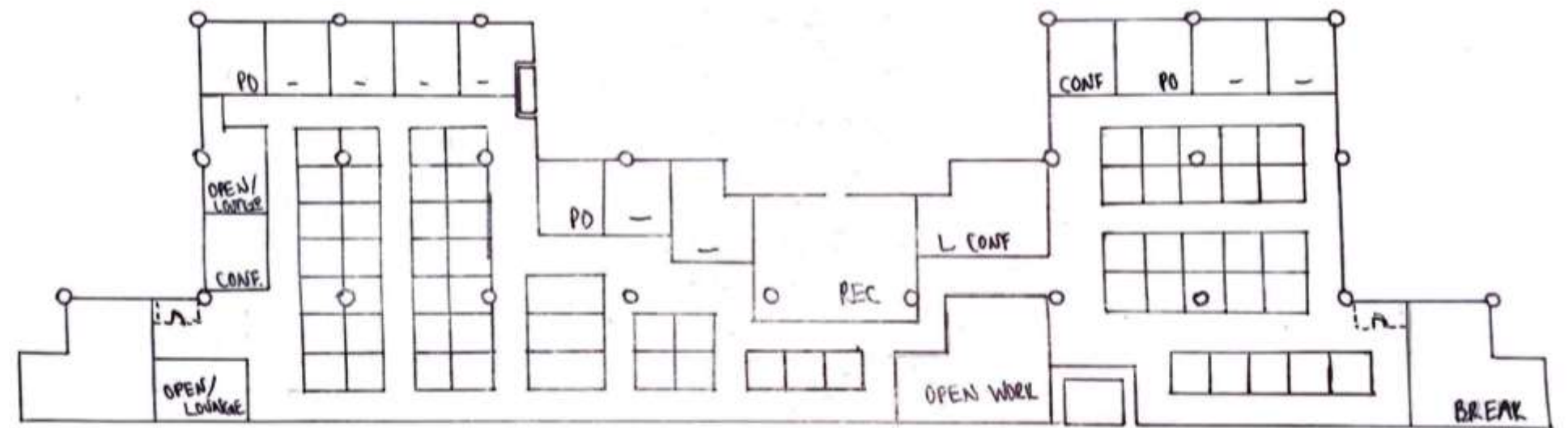
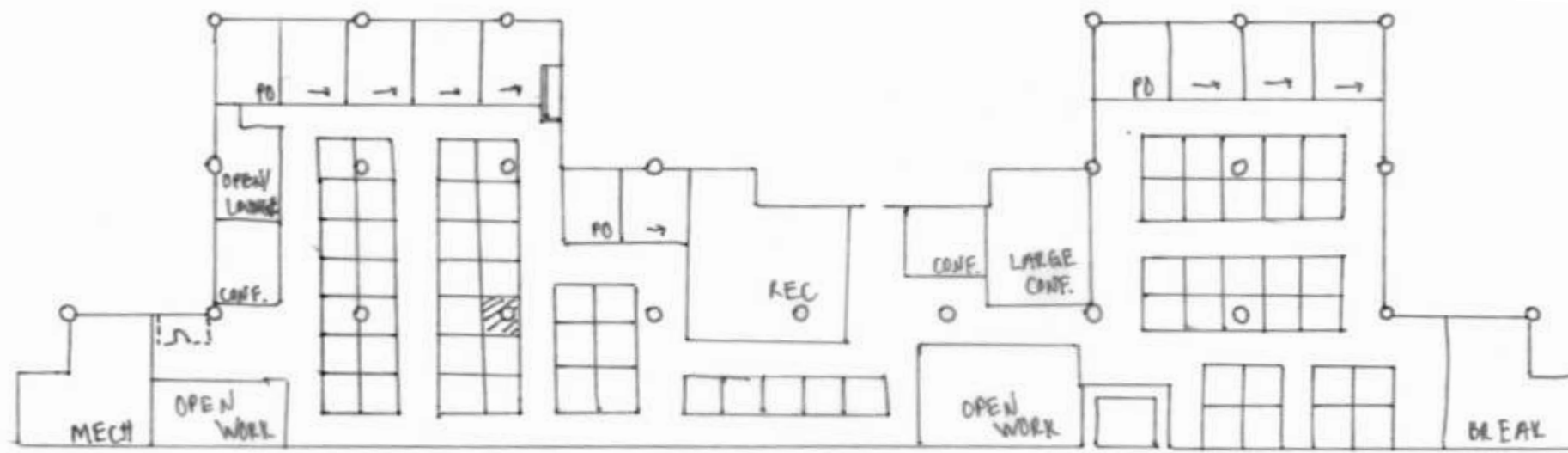

PROBLEM RESOLUTIONS

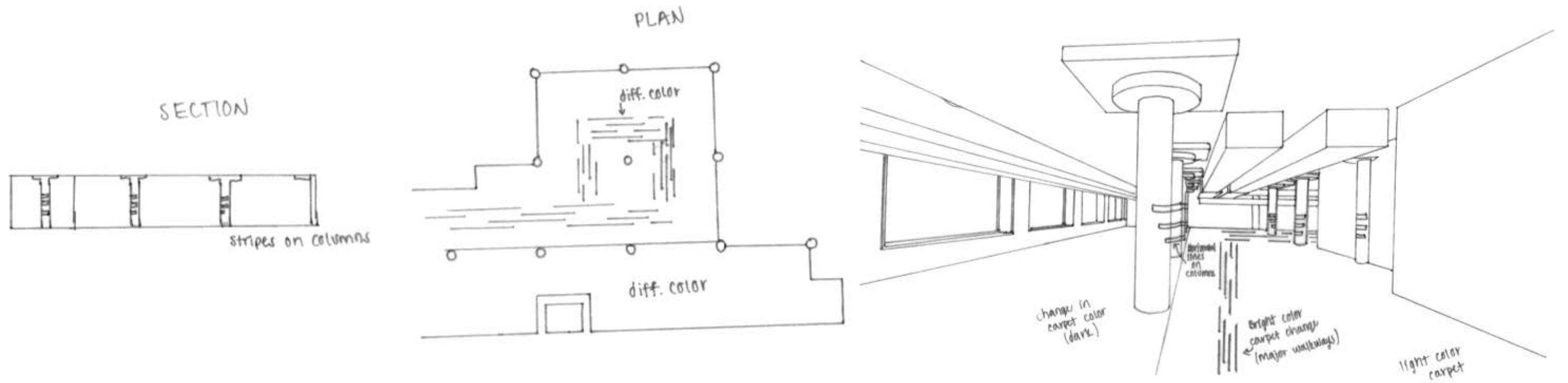

WAYFINDING
OPTION 1

PROBLEM RESOLUTIONS

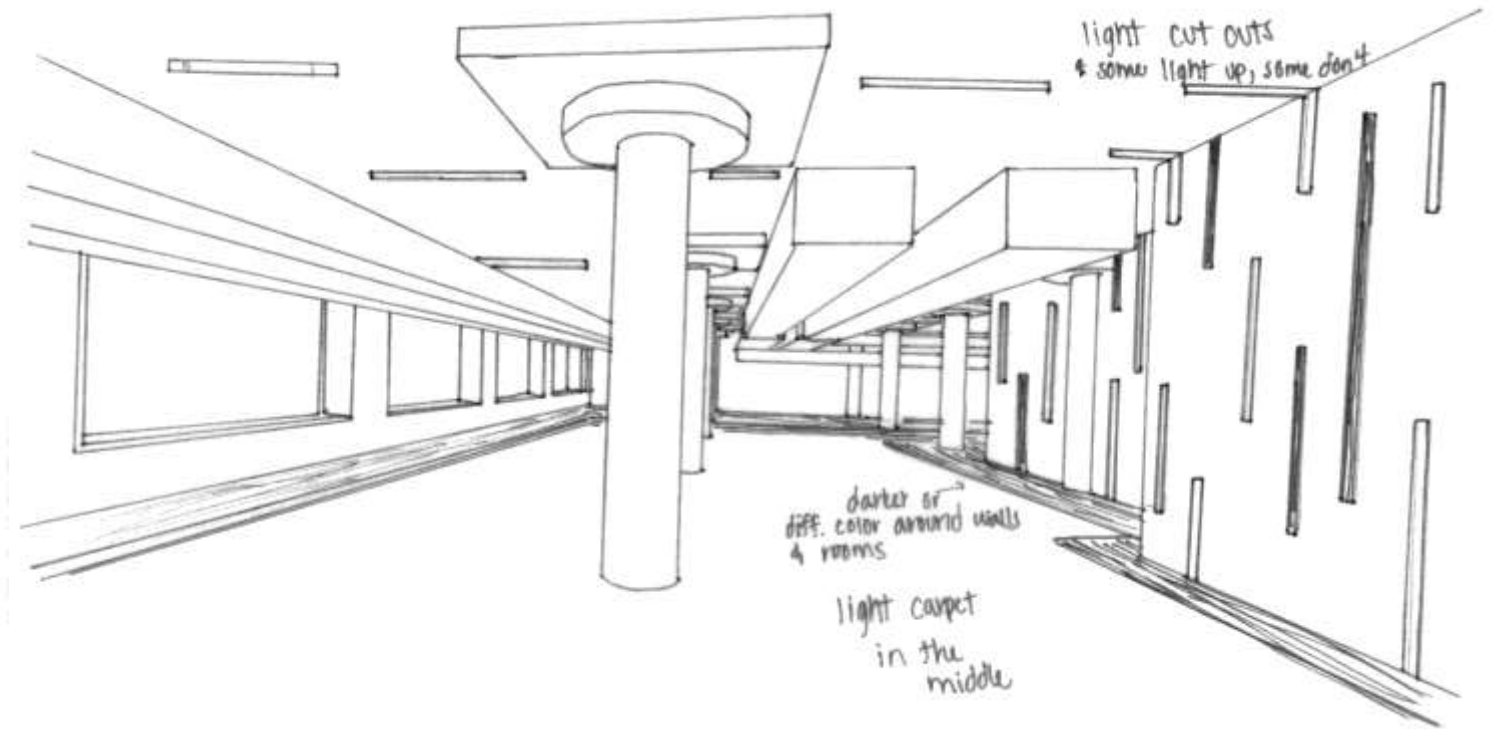
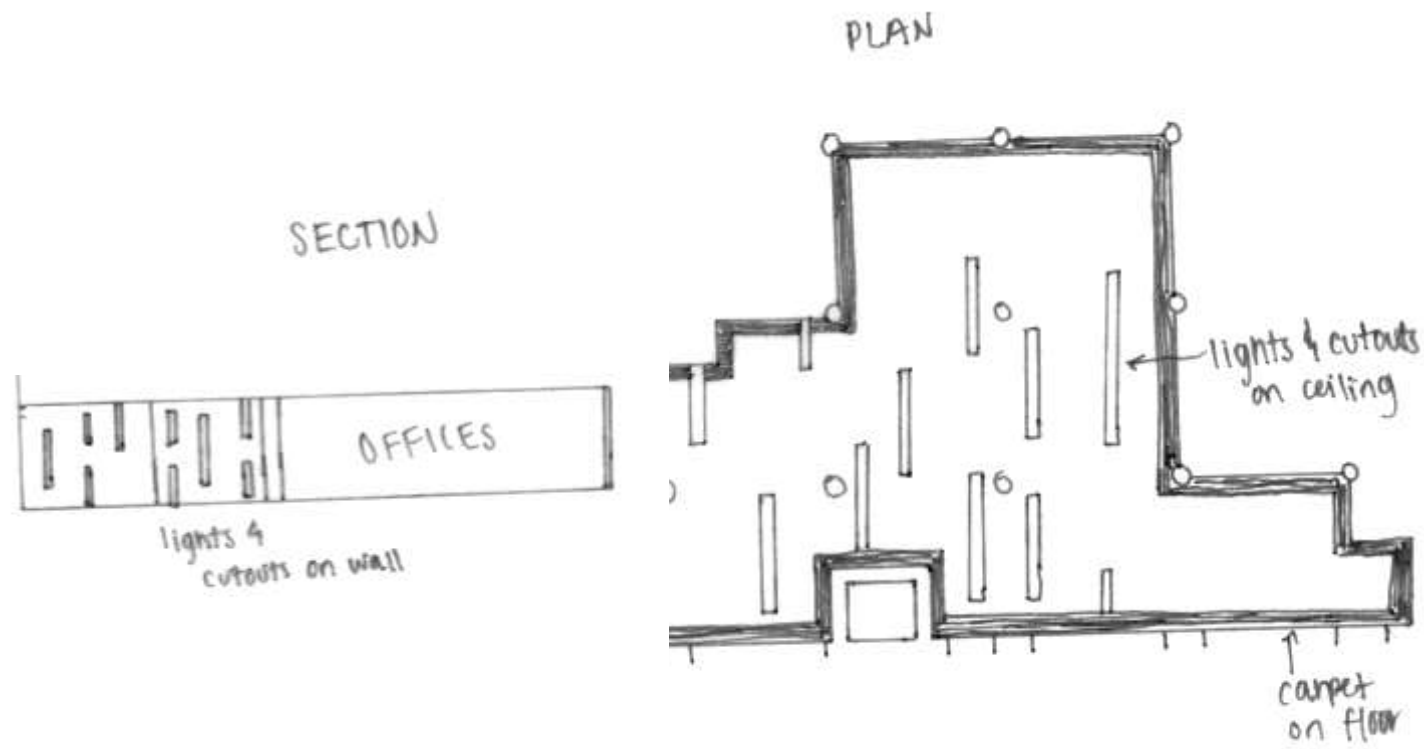

WAYFINDING
OPTION 2

PROBLEM RESOLUTIONS

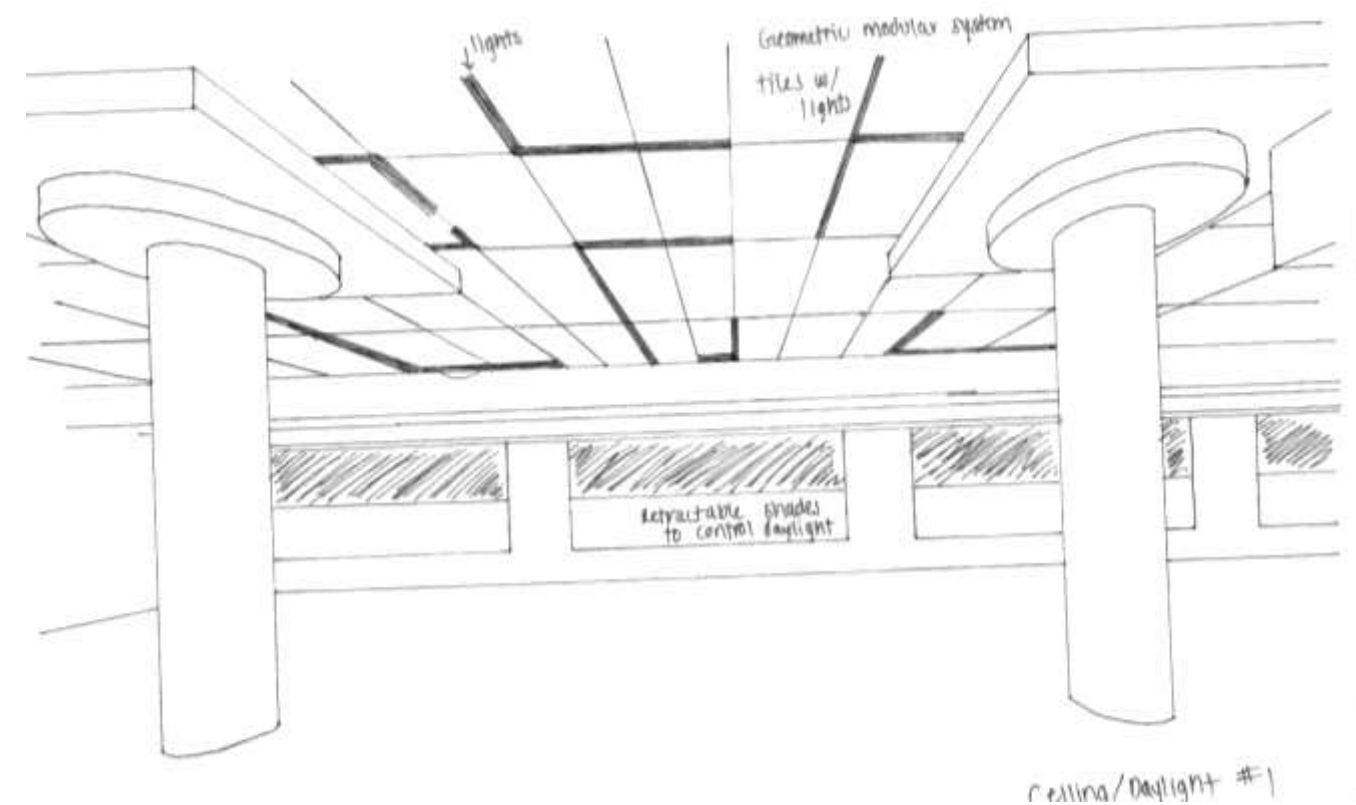
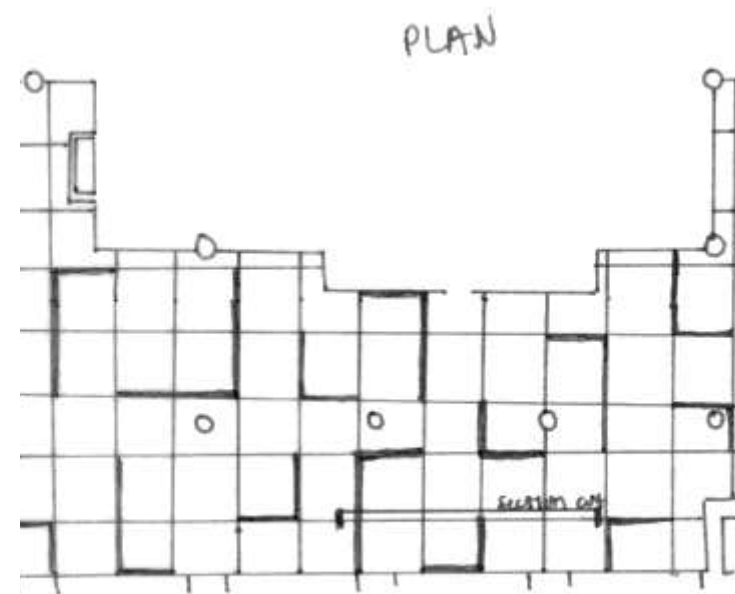
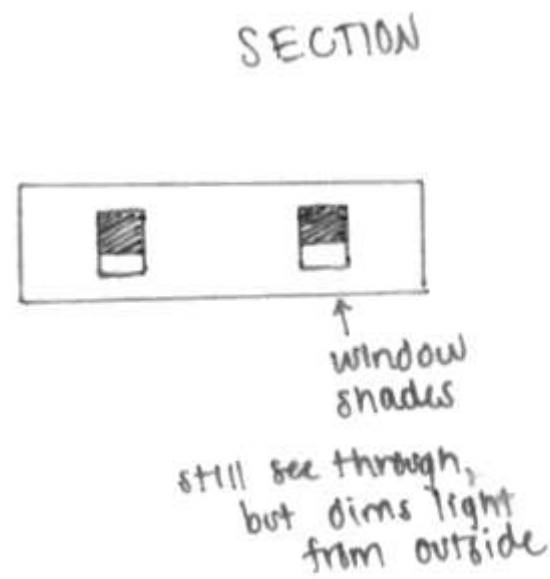

CEILING/DAYLIGHTING
OPTION 1

PROBLEM RESOLUTIONS

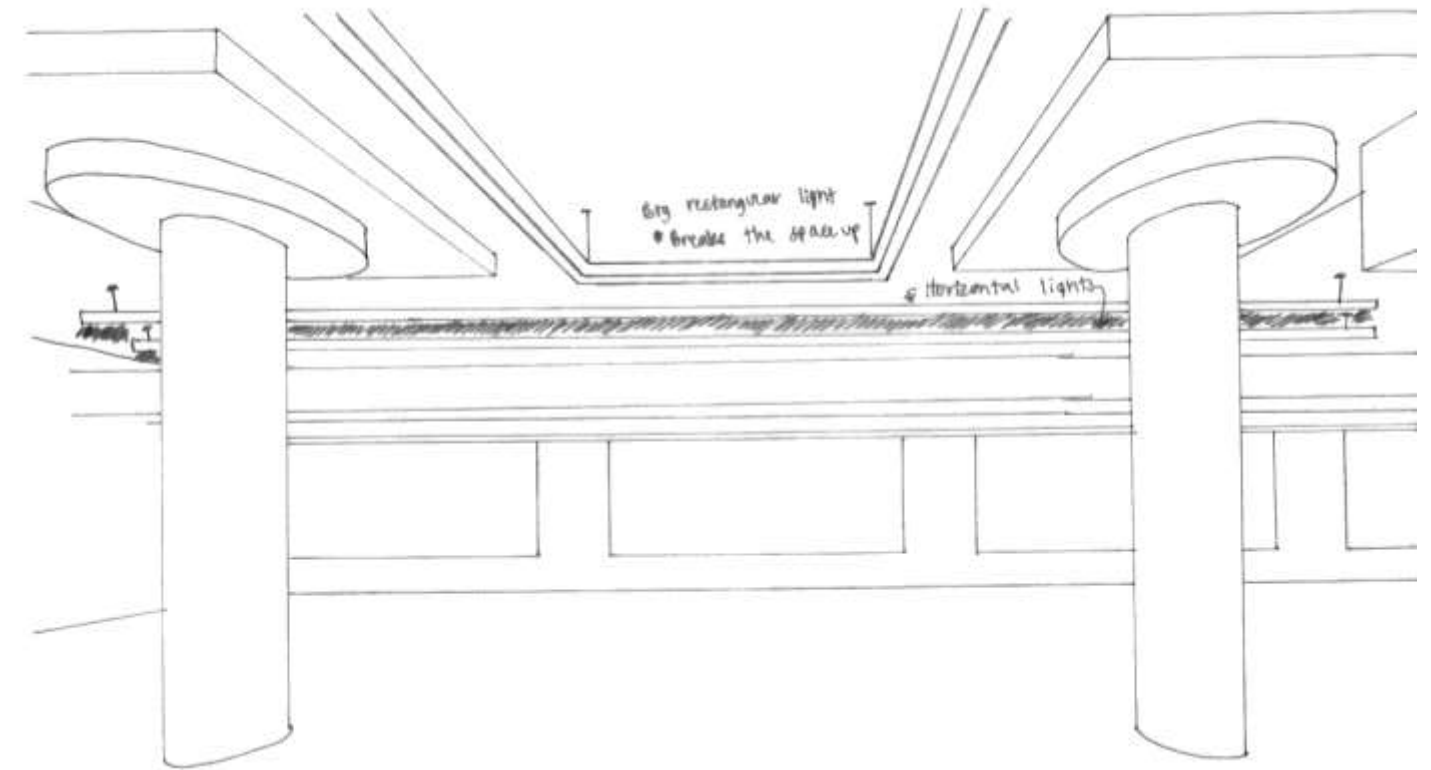
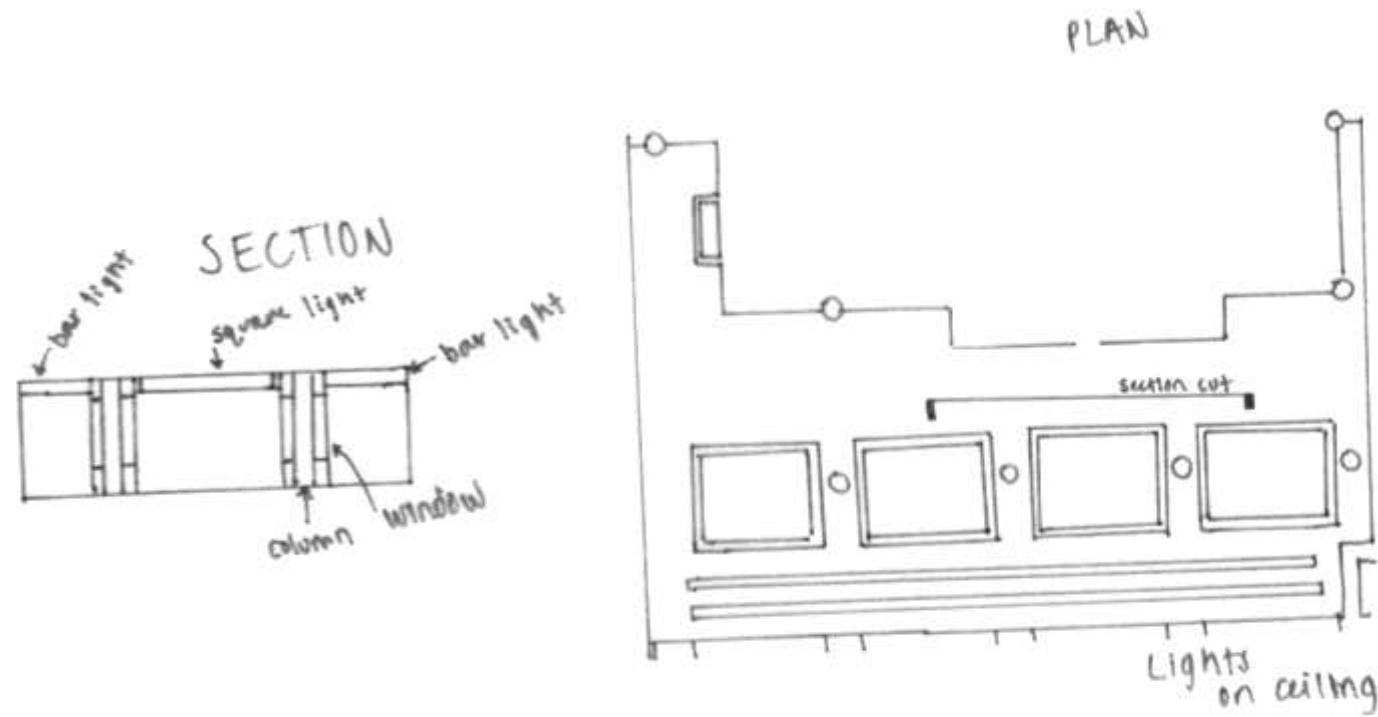

CEILING/DAYLIGHTING
OPTION 2

PROBLEM RESOLUTIONS

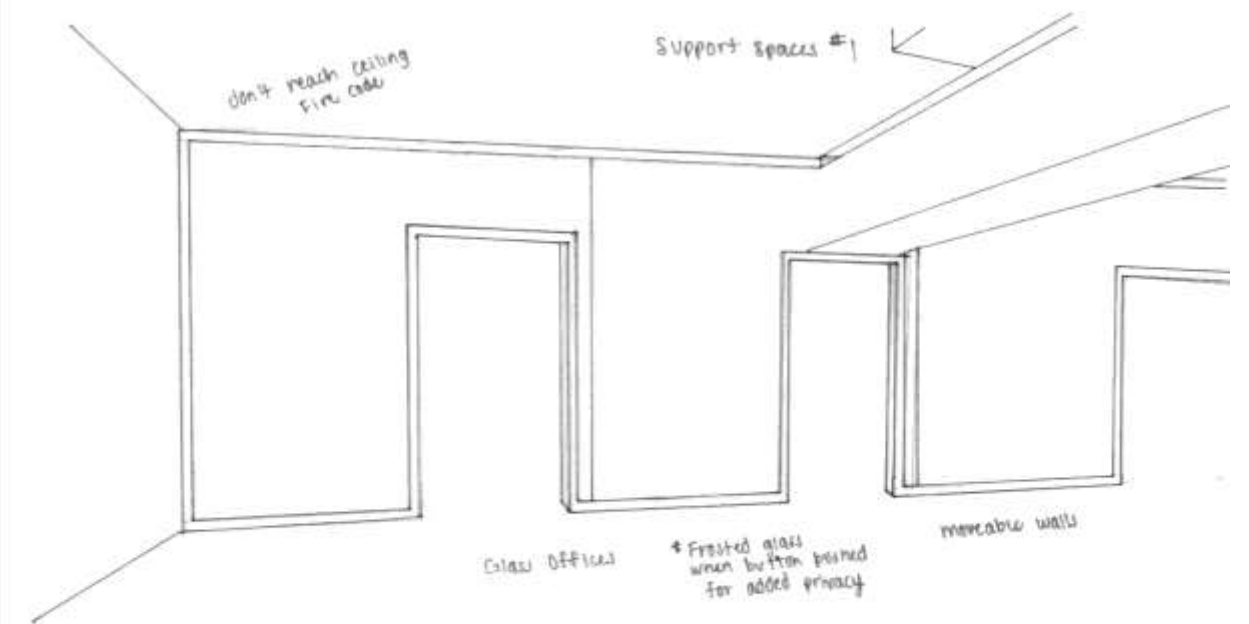
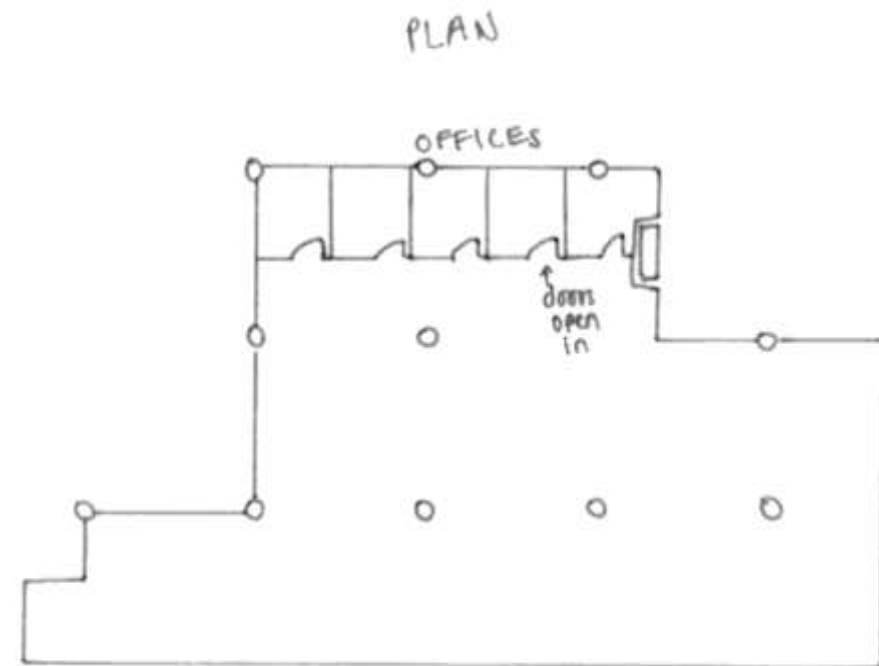
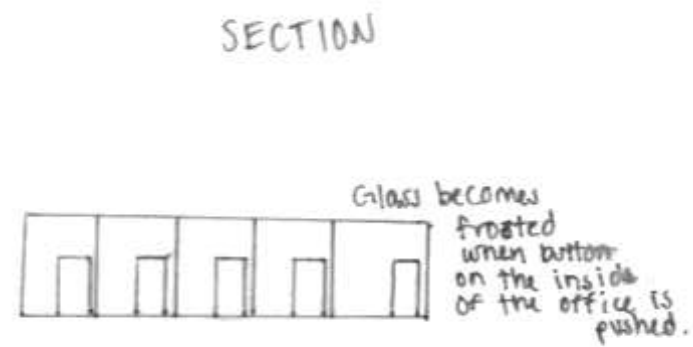

SUPPORT SPACES
OPTION 1

PROBLEM RESOLUTIONS

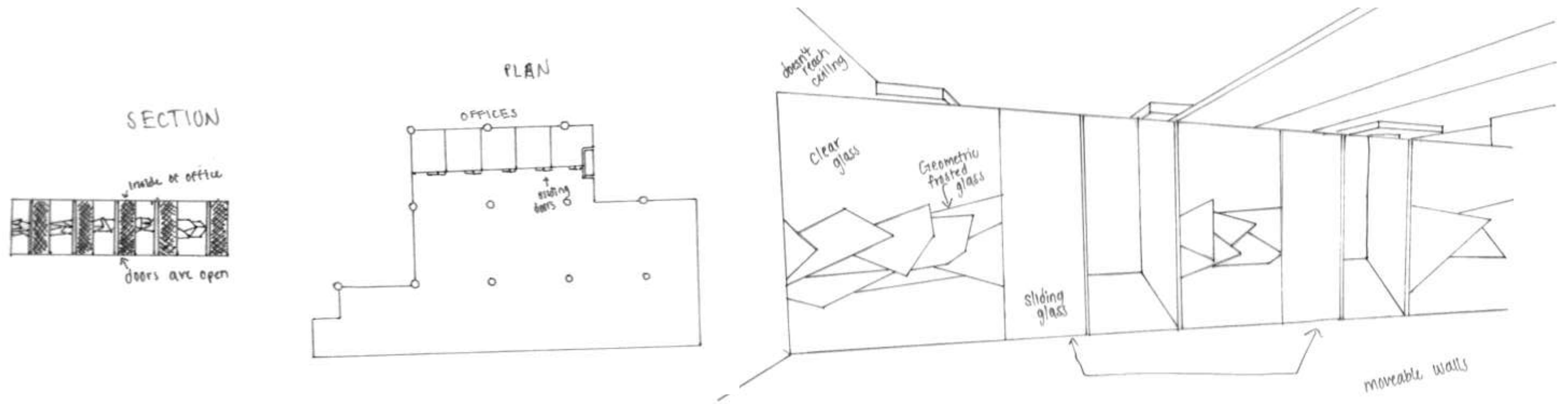

SUPPORT SPACES
OPTION 2

DESIGN SKETCHES

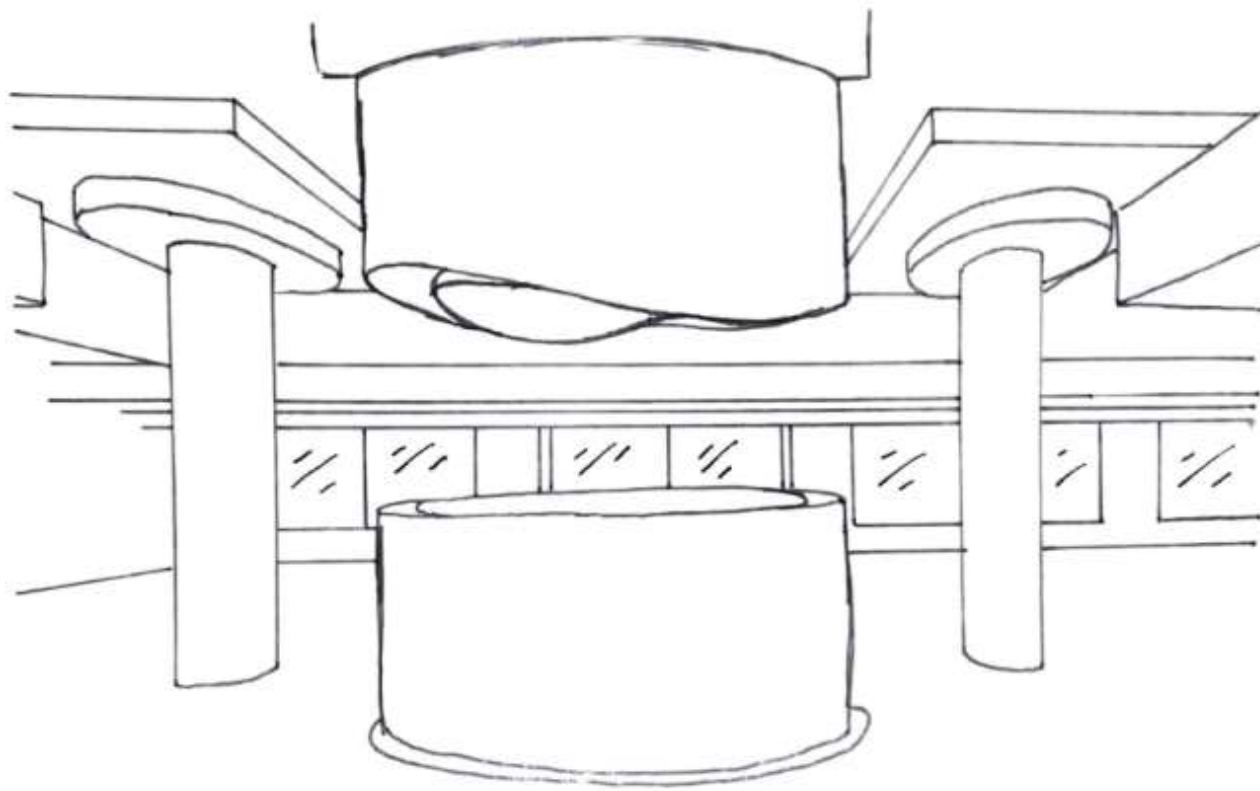

* lights shining up from the bottom of desk.
* lights shining down from ceiling

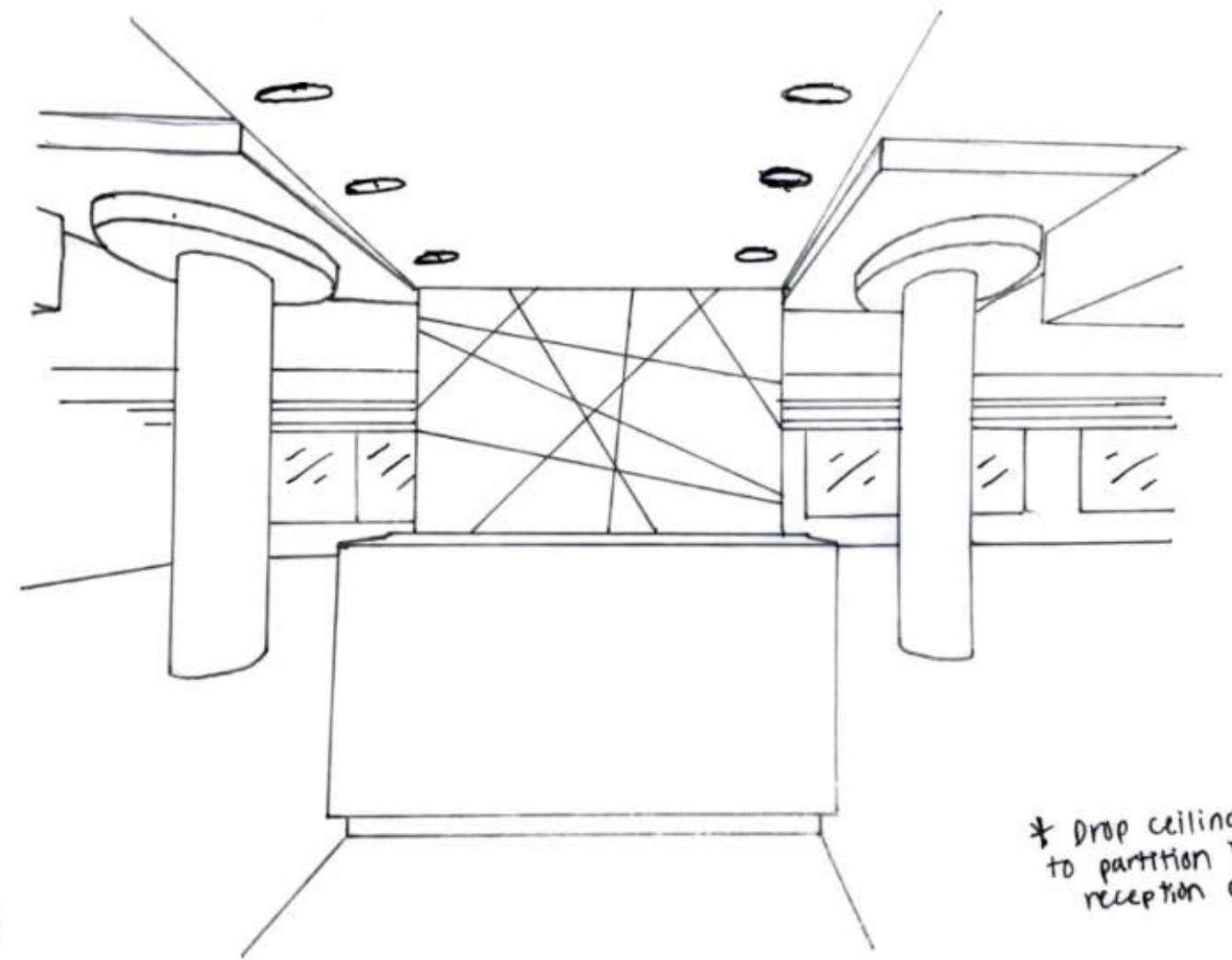

* Drop ceiling attached to partition behind reception desk

ENTRY/RECEPTION

DESIGN SKETCHES

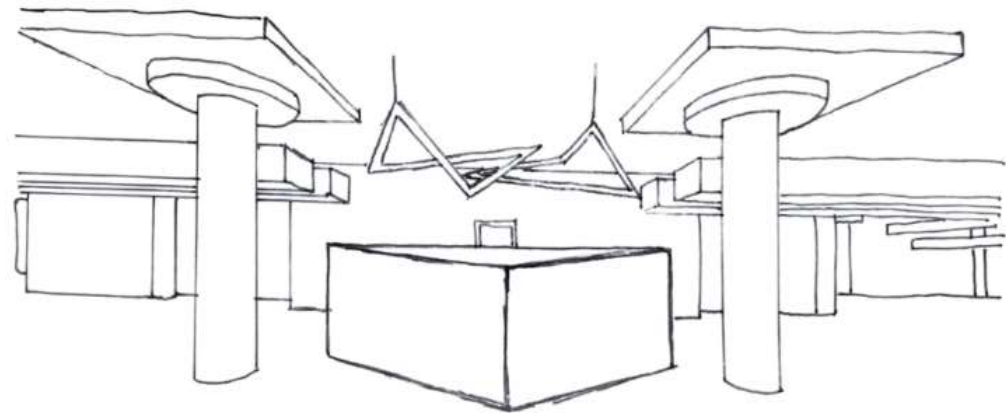

Back view
Triangle shaped desk
w/ geometric LED
lights hanging above

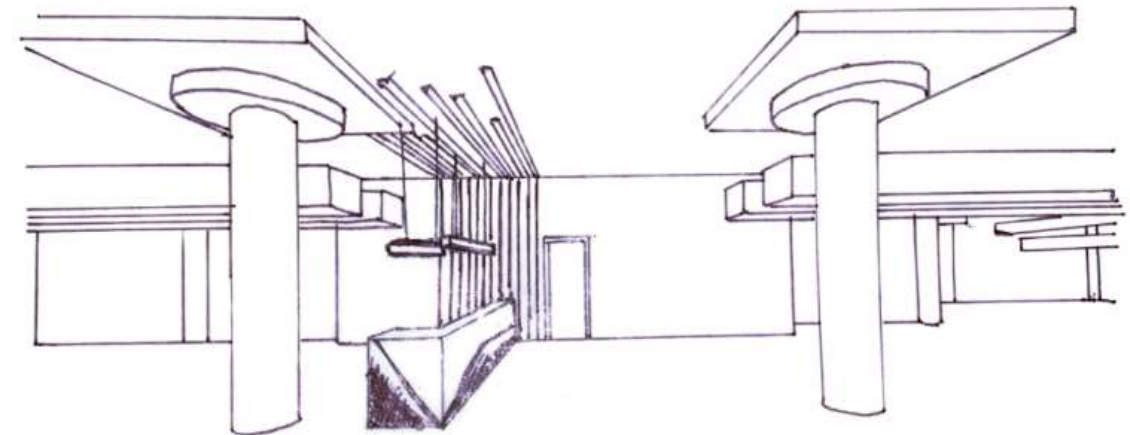

Lights hanging above
desk on wood planks
Lights under cut part of
desk

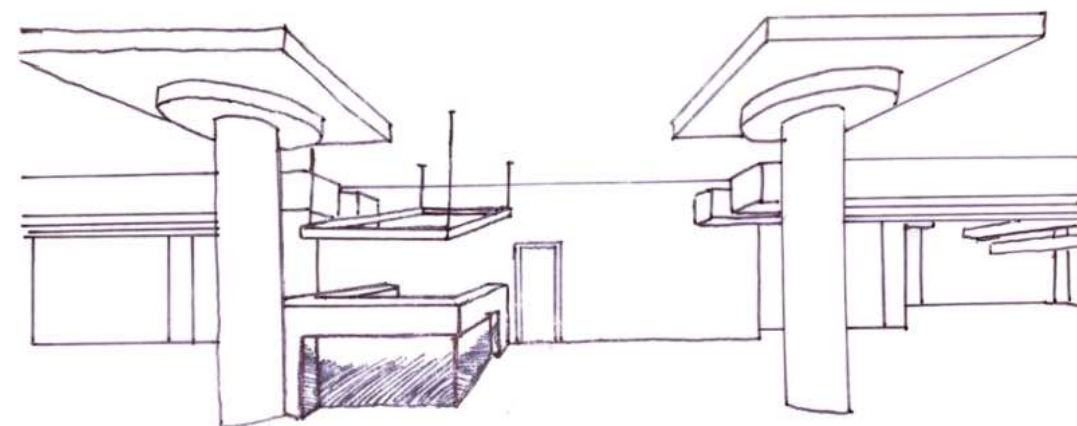

Lights under desk
Rectangle light hanging
above desk

ENTRY/RECEPTION

DESIGN SKETCHES

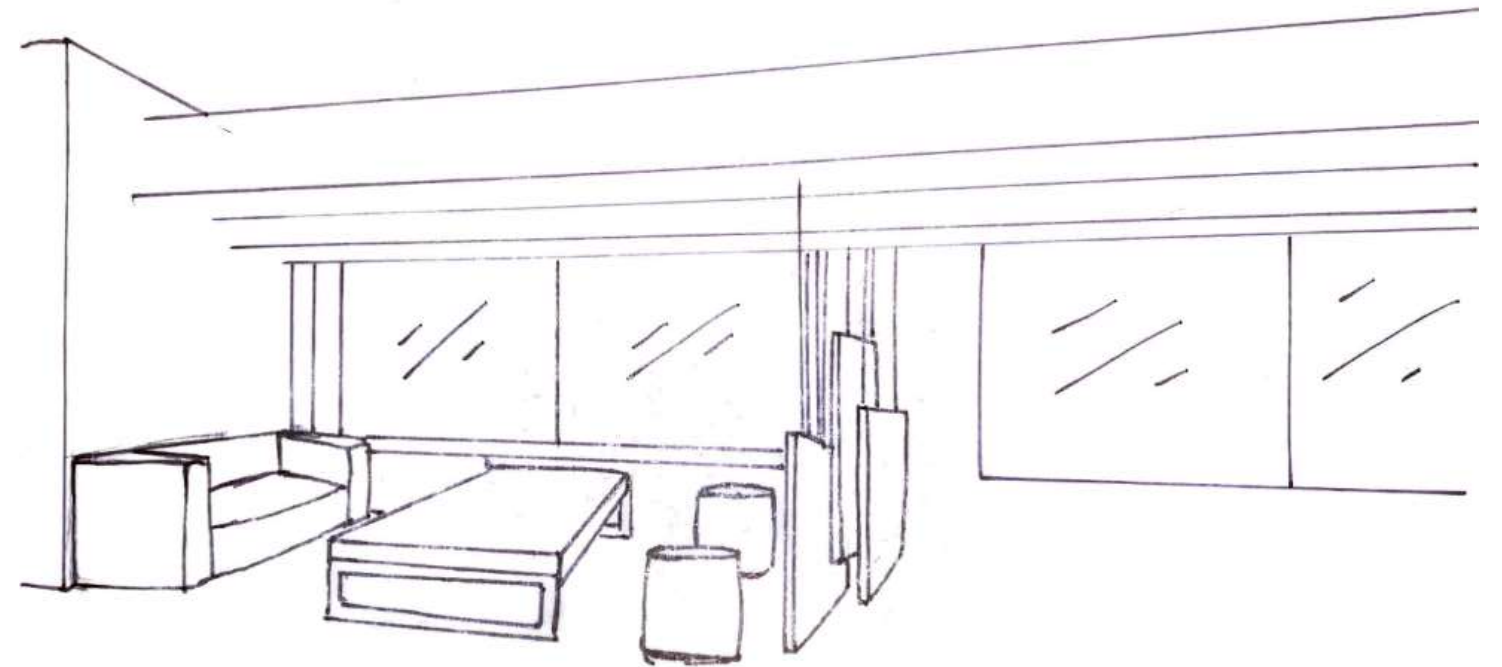
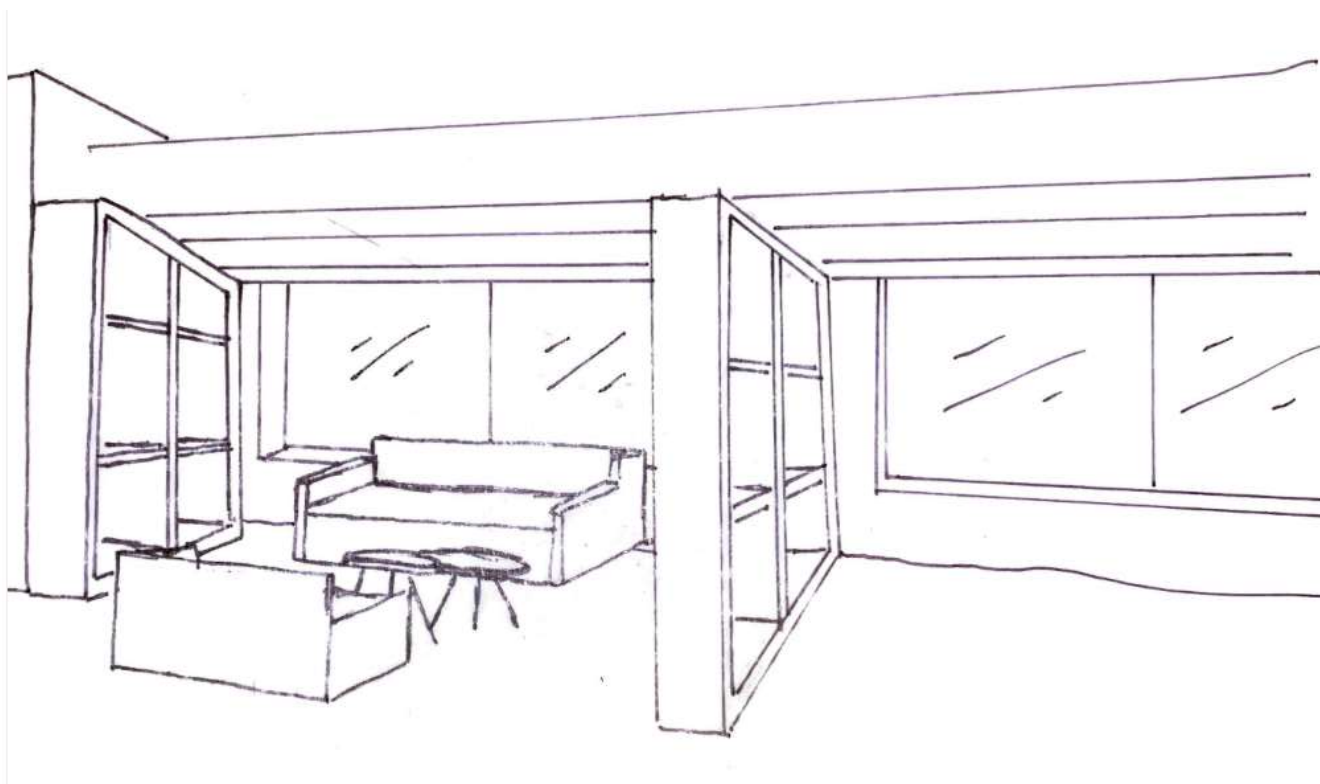

↑ maybe glass shaded w/
diff. colors

CONCEPT LOUNGE

DESIGN SKETCHES

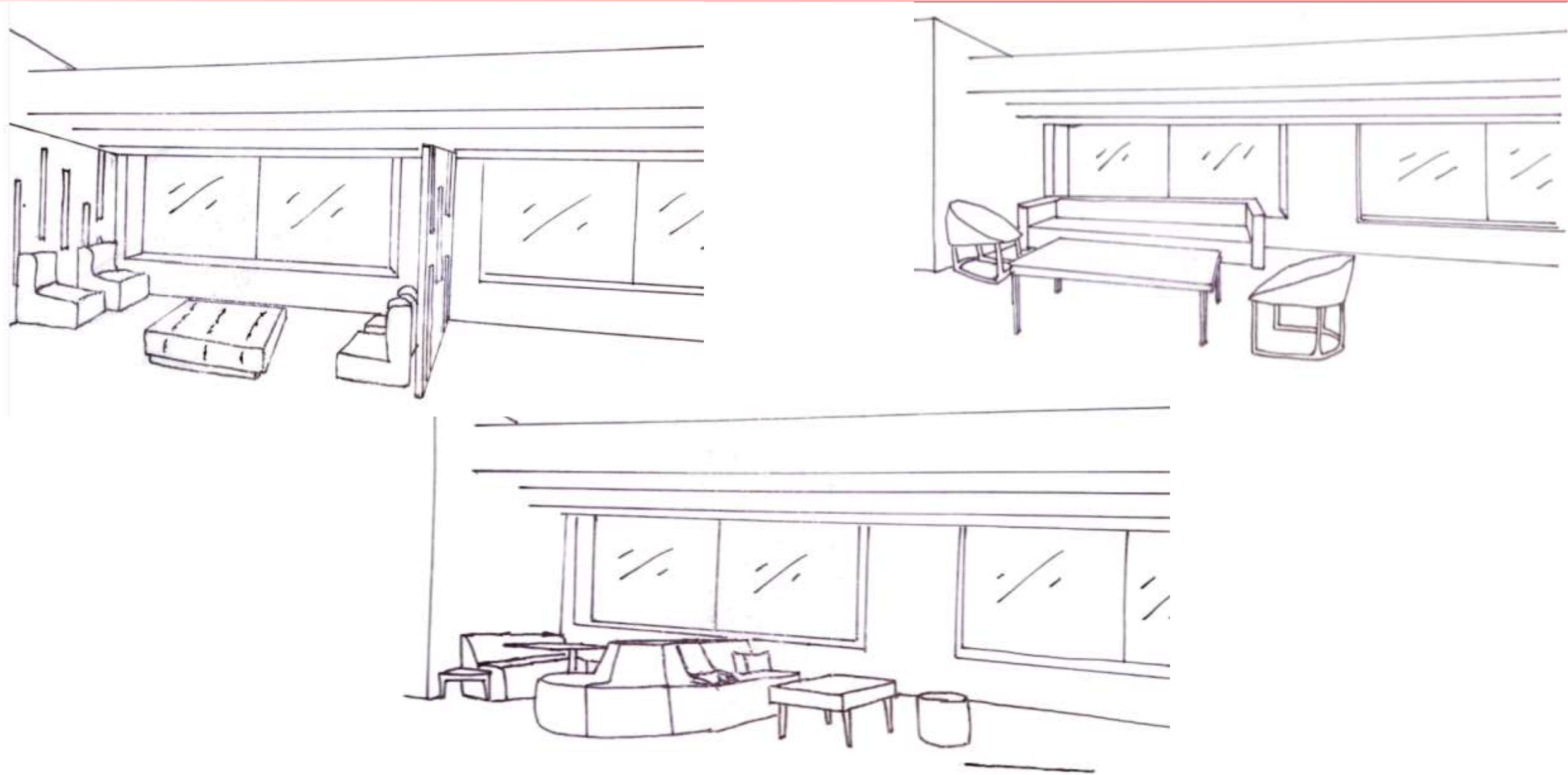

CONCEPT LOUNGE

DESIGN SKETCHES

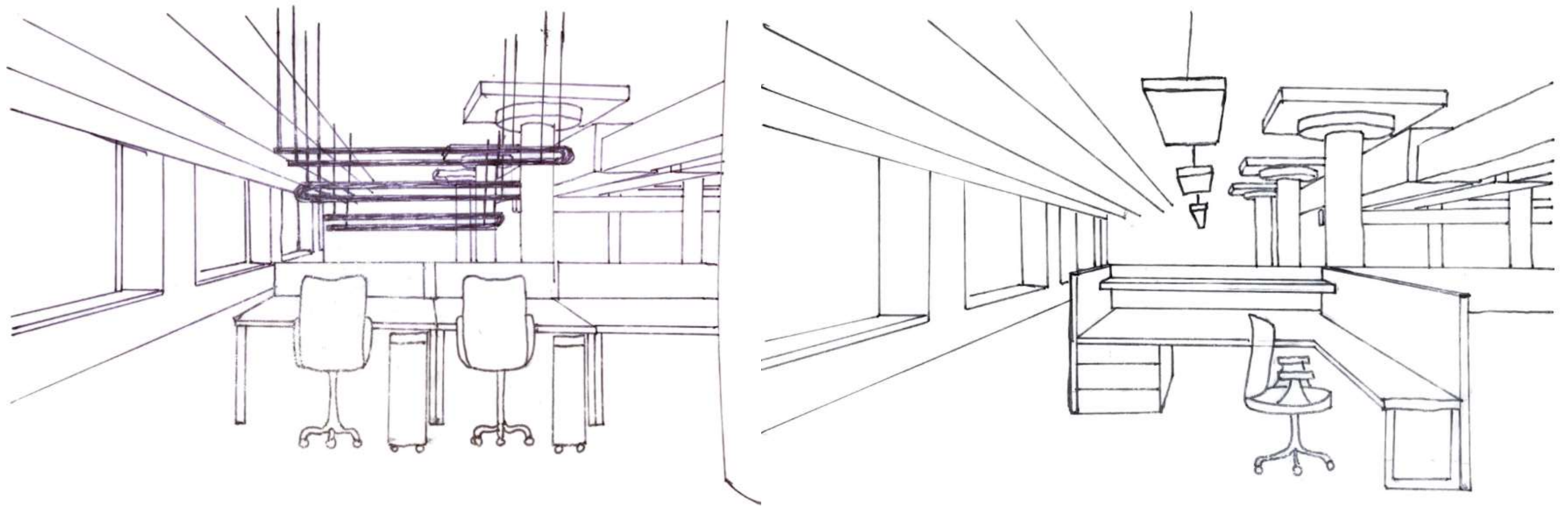

OPEN WORK AREA

DESIGN SKETCHES

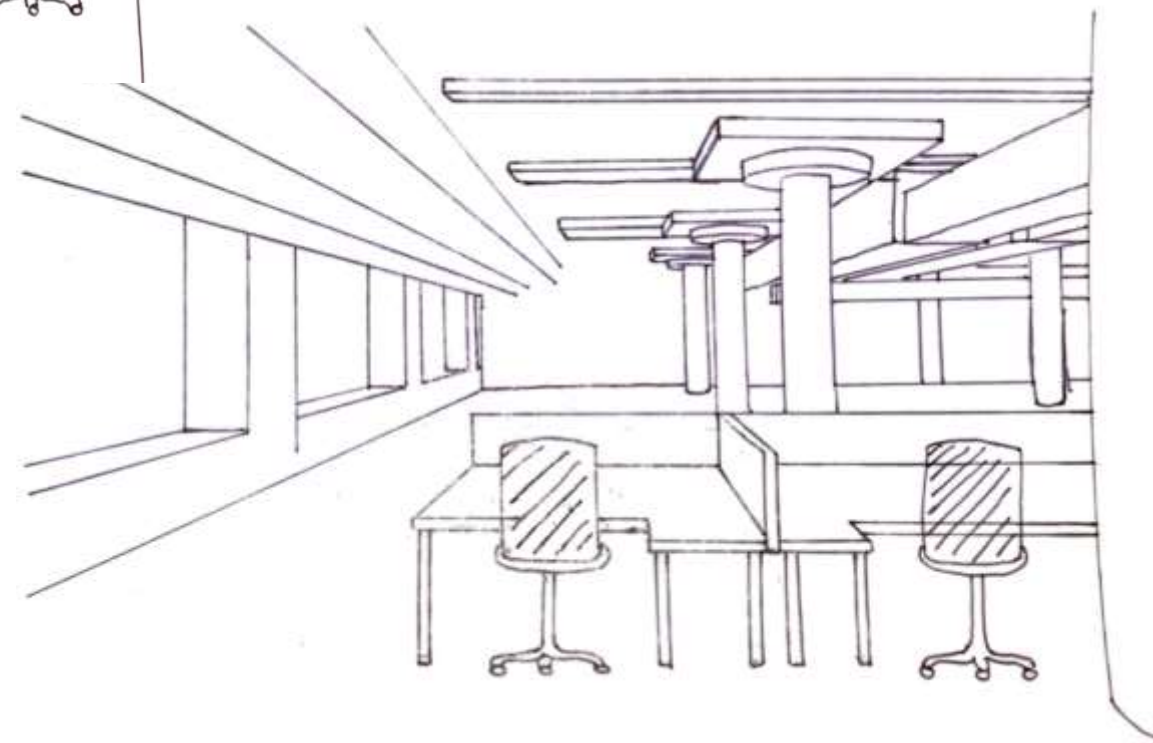
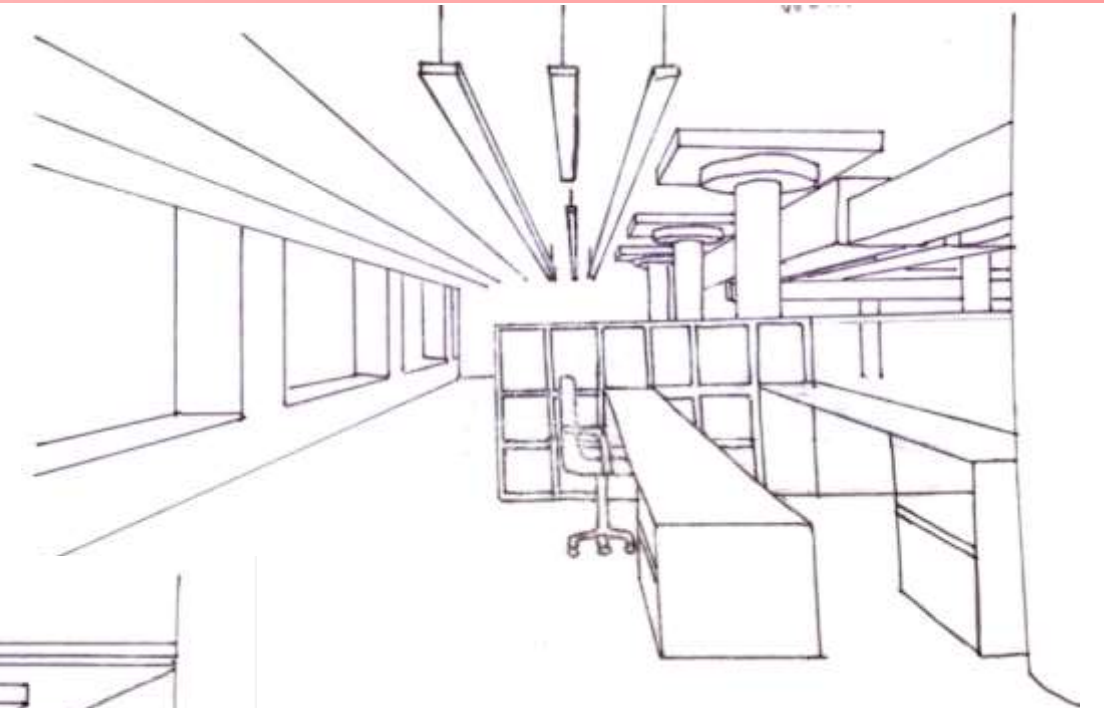
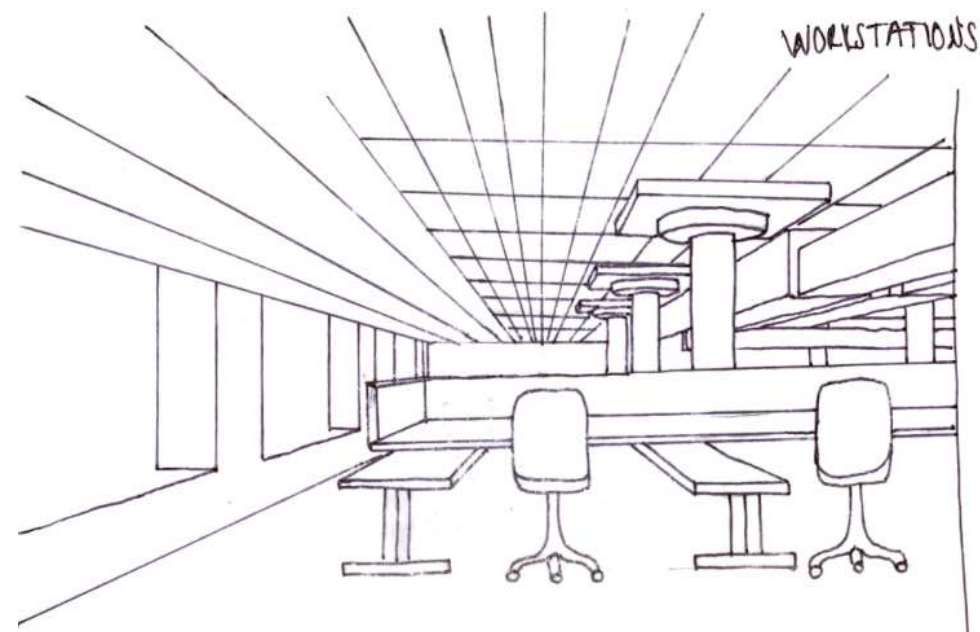

OPEN WORK AREA

LIGHTING MODEL

